



## EZ-2 4.0

All Models

# Disclaimer

Copyright © 2024 Genevac Ltd.

All trademarks referenced in this document are registered or common law trademarks of SP Industries, Inc. or its affiliates in the U.S. and/or other countries.

EZ-2 4.0 - All models

Original Instructions

The U.S. English version of this document is the original instructions.

All other languages are a translation of the original instructions.

Genevac Ltd.  
The Sovereign Centre  
Farthing Road  
Ipswich, Suffolk  
IP1 5AP, United Kingdom

+44 (0) 1473 240000

SP Service (US) +1 (877) 548-4666

SP Service (OUS) +44 (0)1473 243000

SP Service Email: [service@scientificproducts.com](mailto:service@scientificproducts.com)

Website: [scientificproducts.com](http://scientificproducts.com)

This Evaporator Installation and Maintenance Manual contains confidential and proprietary information of Genevac Ltd. (hereinafter "Company") and may be used only by a recipient designated by and for purposes specified by Company. You may not disclose the contents of this Evaporator Installation and Maintenance Manual to any unauthorized third party. You agree that you will only provide this Evaporator Installation and Maintenance Manual to officers, employees, contractors, or other service providers who have a need to know this information and who are bound by written confidentiality obligations.

You may only use this copy of this Evaporator Installation and Maintenance Manual. Unless otherwise authorized by Company in writing, you have no right to reproduce, distribute, modify, create derivative works, publicly display or perform this Evaporator Installation and Maintenance Manual. Permitted copies of this document must retain all proprietary notices contained in the original.

Your purchase of the equipment is governed by Company's then-current terms of purchase. The information in this document is subject to change at any time in Company's sole discretion without notice. As such, we suggest that you regularly confirm with Company that you are using the most current version of this document. Company is free to modify any of its products and services, in any manner and at any time.

EXCEPT AS EXPRESSLY PROVIDED HEREIN, THE CONTENTS OF THIS DOCUMENT SHALL NOT CONSTITUTE ANY WARRANTY OF ANY KIND, EITHER EXPRESSED OR IMPLIED, INCLUDING BUT NOT LIMITED TO THE IMPLIED WARRANTIES OF MERCHANTABILITY AND/OR FITNESS FOR A PARTICULAR PURPOSE OR GIVE RISE TO ANY LIABILITY OF COMPANY, ITS AFFILIATES OR ITS SUPPLIERS.

<b>1 Safety</b>	<b>4</b>	Vacuum Pump Catch Pot (Elite IGP Only)	20
Warnings and Cautions	4	Vacuum Pump (Elite Only)	21
General Safety Precautions	5	Vacuum Pump Ballast Setting	21
Hazardous Areas & Ventilation	5	Alternative Vacuum Sources	21
Solvent Safety	5	Exhaust Connection	22
Solvent Compatibility	5	Installation Site Ventilation Requirements	22
Electrical Safety	6	Minimum Room Ventilation (Dilution Ventilation)	22
Disconnection of Supply	6	Minimum Local Extraction (Fume Cabinet)	22
Inert Gas Purge	7	Hazardous Atmospheres & Minimum Room Size	23
Seals	7	Multiple Evaporators	23
Hot/Cold Surfaces	7	Re-Circulating Extraction Systems & Fume Hoods	23
Emergency Shut-down	7		
<b>2 Intended Use</b>	<b>8</b>		
Disposal	8		
Maintenance	8		
<b>3 Operation Manual</b>	<b>9</b>		
<b>4 Installation and Commissioning</b>	<b>10</b>	<b>10 Maintenance</b>	<b>24</b>
Packaging	10	Before Use	24
Lifting & Transport	10	After Use	25
Installation Site	10	Weekly Checks	25
Installation - Specific Requirements	10	Following Glassware Breakage	25
EU F-Gas Regulation	10	Use or Spillage of Toxic / Hazardous Substances	25
Hot / Cold Surfaces	11	After Sample Holder Damage / Rotor Crash	25
Refrigerant	11	General Cleaning	26
		Cleaning HCl-Compatible Evaporators	27
		Cleaning & TFA	27
		Cleaning Inert Gas Purge-Enabled Evaporators	27
		Opening the Lid Without Power	28
<b>5 Mains Power</b>	<b>12</b>	Infra-Red (IR) Lamp Replacement	29
Power Connections	12	Lid Seal	30
Maximum Supply Input	12	Lid Seal Troubleshooting	31
Circuit Breaker	12	Condenser Seal	32
Disconnecting the Evaporator	12	Maintenance (Inert Gas Purge)	33
		Before / After Use	33
		Mandatory Maintenance	33
<b>6 Equipment Layout</b>	<b>13</b>		
Standard / Plus Equipment Layout	13	<b>11 Software Update</b>	<b>34</b>
Standard / Plus Equipment Layout (Inert Gas Purge)	14		
Elite Equipment Layout	15	<b>12 Troubleshooting</b>	<b>35</b>
Elite Equipment Layout (Inert Gas Purge)	16	Faults & Errors	35
		Non-Critical Errors	35
<b>7 System Set-Up</b>	<b>17</b>	Critical Errors	35
System Set-Up – EZ-2 Standard & Plus	17	Error Logging	35
System Set-Up – EZ-2 Elite	18	System Audio / Visual Alerts	35
		Providing Error Logs to SP Service	36
<b>8 Waste Solvent Container (Elite only)</b>	<b>19</b>		
		<b>13 Common Problems and Solutions</b>	<b>37</b>
<b>9 Installation</b>	<b>20</b>		
Installation (Inert Gas Purge)	20	<b>Appendix 1 - Fume Hood Compatibility</b>	<b>39</b>
Inert Gas Supply	20		

Users must be familiar with all the issues outlined in this user manual before attempting to operate the equipment. Any personnel without sufficient training and/or experience to understand any hazards that may arise while operating the equipment should not be permitted to use it.

A risk assessment in accordance with applicable local or national regulations should be carried out for each solvent before use. The possible consequences of applying vacuum to solvent mixtures should always be considered during this assessment.

## Warnings and Cautions

The following warning symbols are used in this manual and/or on the product:



Refer to User Manual. Wherever this symbol is displayed, the user shall refer to the user manual in order to determine any actions needed to avoid a hazard.

---



Cold surface hazard

---



Hot surface hazard

---



Electric shock hazard

---



General warning

---



Drain Port Cold Surface Hazard

---

## General Safety Precautions

Observe the following safety precautions when operating the evaporator:

- Only operate the evaporator in a sufficiently ventilated space.
- Start system immediately after loading to prevent vapor build-up in the system.
- Ensure that all exhaust hose connections are securely and independently connected to suitable laboratory fume extraction systems at all times.
- Ensure that the condenser jar has been emptied / condenser pot has been drained and the waste solvent container emptied before starting the evaporator.
- Only use sample holders and swings that are approved for use by SP.
- Do not start or restart the evaporator without ensuring that it is correctly loaded.
- Do not leave the evaporator unevenly loaded (someone else may start it).
- Do not place or store items on top of or beside the evaporator.
- Clean up any solvent spills immediately.

## Hazardous Areas & Ventilation

This equipment is intended for installation in ordinary, non-Hazardous or Classified, indoor locations, and shall be installed in accordance with the latest Edition of the National Electrical Code, NFPA 70 or the national equivalent, where the ambient temperature does not exceed 40°C (104°F) maximum.

Refer to the **Installation - Specific Requirements** section of this manual for information on minimum ventilation requirements.

## Solvent Safety



**WARNING:** Some of the solvents approved for use with the EZ-2 may be subject to occupational exposure limits. Small quantities of solvent liquid or vapor may be present in the condenser or evaporation chamber at the end of an evaporation run. Appropriate protective equipment shall be worn when working with potentially harmful solvents, in accordance with local or national regulations.



**WARNING:** Evaporating combustible solvents may create a vapor ignition hazard. Minimum ventilation requirements shall be adhered to at all times. Only load the evaporator when you are ready to use it. Clean up all spills immediately.

For specific precautions when using flammable solvents, please refer to the **Safety Measures for Flammable Solvents** in the **EZ-2 Operations manual**.

## Solvent Compatibility



**WARNING:** Low auto-ignition point solvents (such as Diethyl Ether or Pentane) shall not be permitted for use unless the evaporator is fitted with the Inert Gas Purge system.



**WARNING:** HCl, Thionyl Chloride or other acid chlorides shall not be permitted for use in the EZ-2 unless the evaporator is HCl-compatible. Acids and acid solutions shall not be prepared or stored near the evaporator, even for short periods.



**WARNING:** Do not use unapproved solvents in the EZ-2. Refer to the list of acceptable solvents in this user manual for solvent compatibility information. Contact SP for advice before using any solvents that are not listed.

## Electrical Safety

The evaporator is a Protection Class I product and shall not be used with any interruption to the electrical earth conductor. This equipment is rated for use in Pollution Degree II environments and is intended to operate from a normal single-phase supply.



**WARNING:** Do not connect to supplies providing more than 1500 A, or with a short-circuit current equal to, or exceeding 1.5 kA.

To prevent nuisance tripping, the mains power supply to the evaporator shall be fitted with a suitably rated Type-D (or equivalent) mains circuit breaker. This circuit breaker shall be installed near the equipment. If using an earth leakage device, use at least a 30 mA rated unit to avoid trips at start-up.



**WARNING:** If using flammable solvents, take anti-static precautions when loading and unloading the evaporator.

If the evaporator has spent a prolonged period below room temperature (e.g. during transit or storage), do not operate the evaporator for at least one hour after installation to allow the system to acclimatize and disperse any condensation etc.

## Disconnection of Supply

To disconnect the supply, remove the plug from the mains power connection. During installation and operation, sufficient access to the disconnection device (plug) shall be made available.

After disconnection, the operator shall wait at least ten seconds before reconnecting the supply or performing maintenance of any kind.

## Inert Gas Purge



**WARNING:** Asphyxiation hazard. Inert gas may leak from the evaporator during operation of the Inert Gas Purge system. To avoid the risk of asphyxiation, minimum ventilation requirements shall be complied with at all times and all hose connections shall be secured before use.

Refer to the **Installation Site Ventilation Requirements** section of this manual for information on minimum ventilation requirements.

## Seals



**WARNING:** Seals provided with the EZ-2 are not bioseals and cannot be relied on for protection against micro-organisms.

## Hot and Cold Surfaces



**WARNING:** The condenser operates at temperatures in excess of  $-50^{\circ}\text{C}$  to  $+60^{\circ}\text{C}$ . Allow the condenser to reach room temperature before conducting any operation near the condensing coil. Note that some solvents may still be liquids at temperatures below  $0^{\circ}\text{C}$ . Always wear suitable personal protective equipment as indicated by risk assessment.



**CAUTION:** At the completion of an evaporation run, sample holders and the lamp window may be hot. Take care when unloading sample holders. Do not touch the lamp or the lamp window until they have been allowed to cool.

## Emergency Shutdown

All SP Genevac evaporators are designed to be safe with respect to the user and to samples when switched off in an emergency. When power is removed, the evaporation chamber automatically vents to atmospheric pressure and the rotor spins down slowly.

Once powered on again, the system will not allow access to the evaporation chamber for a period of up to 10 minutes after shut-down to ensure the rotor has slowed to a safe speed.

To shut down in an emergency, unplug the evaporator from the mains supply. Users shall familiarize themselves with the location of the connections to the mains supply and ensure that power sockets and plugs are always accessible.

SP EZ-2 evaporators are intended for evaporation and concentration of samples dissolved in solvent(s) for laboratory research, development and analysis purposes only. Acceptable solvents are defined in the "Acceptable Solvents" list contained within this user manual; SP may evaluate and advise on the suitability of additional solvents on request. Contact SP before attempting to use any unapproved solvent.

The EZ-2 Evaporator is not suitable for the processing or manufacture of foodstuffs, radioactive substances, or cosmetics or pharmaceuticals intended for human or animal consumption. If in doubt, contact SP for advice. This product shall be installed in laboratory or similar environments only.



**WARNING:** Use of the EZ-2 outside of its intended use may impair the protection provided by the machinery.

---

## Disposal

---



**CAUTION:** Risk Of Fire Or Explosion. Dispose Of Properly In Accordance With Federal Or Local Regulations. FLAMMABLE REFRIGERANT Used.

---

## Maintenance

Any maintenance or repair of this product, other than that specified within this user manual, should be carried out by an authorized SP representative using SP approved components. SP offer a comprehensive range of service contracts designed to keep your evaporator in top condition. Maintenance areas which require tools to access, except those procedures described in this manual, should be performed by authorized SP representatives only.



This manual is intended to be read in conjunction with the Operation Manual provided with the system. Both manuals should be retained for the lifetime of the system and stored near the system for ease of reference.

Operation Manual



EZ-2 4.0

All Models



ATS  
SCIENTIFIC PRODUCTS GENEVAC

## Packaging

The EZ-2 evaporator will be delivered to you in a cardboard packing crate. Where possible, retain the crate and any accompanying packaging. In the unlikely event that the evaporator needs to be returned to Genevac, the crate and packaging may be re-used. Replacement crates and packaging can be supplied, subject to a charge for materials and shipping costs.

## Lifting & Transport

EZ-2 evaporators can weigh up to 90 Kgs (depending on selected build options). For safe handling and installation, follow the instructions provided in the **EZ-2 Installation Guide**.

The evaporator is stable:

- When the product is packed for shipment; and
- When the equipment is correctly installed (either on a suitable work-surface, or to an SP Genevac Infinity Trolley).



**WARNING:** Do not move or transport the evaporator with samples inside.

---

Stability cannot be guaranteed when moving or transporting the evaporator to a new location, or during maintenance by SP service personnel.

## Installation Site

This equipment is intended for installation in ordinary, non-hazardous or classified locations and shall be installed in accordance with the latest edition of the National Electrical Code, NFPA 70 or the local/national equivalent, where the ambient temperature does not exceed 40°C (104°F) maximum.

This product is intended for installation in laboratory or similar environments only. A risk assessment should be carried out when selecting a suitable installation site, in accordance with local or national requirements.

## Installation - Specific Requirements

The evaporator shall be installed on a heavy-topped bench that is secured to the floor to prevent movement or vibration. The bench shall have a minimum load capacity of 200 kg and shall be resistant to chemical spillage. The evaporator shall not be installed on a flammable surface.

Enough space shall be provided to position the evaporator away from the edge of the work-surface and any breakable objects or areas where entrapment may occur. Installation of the EZ-2 requires the following:

- A 50 mm air-gap between the evaporator and any other object;
- Exhaust connection to a suitable laboratory fume extraction system;
- Ventilation equal to, or in excess of, the minimum requirements;
- Connection to a suitable mains power outlet and access to that outlet during operation;
- Sufficient access for maintenance and general operational requirements.

# Installation and Commissioning

**NOTE:** Exhaust hoses shall be connected directly to a suitable laboratory fume extraction system, even where the evaporator is installed in a fume hood.

The temperature at the installation site shall be within the limits stated in the “**Technical Specifications**” section of the **Operations Manual**. Please refer to Installation Site Ventilation Requirements later in this manual for information on ventilation requirements.

Hoses etc. shall be installed as per the diagrams on the following pages. 8mm PTFE hoses should be measured and cut to appropriate lengths for the particular installation.



**WARNING:** No smoking! No flame! Do not use electrical parts which may produce sparks around the evaporator or when operating the equipment.

---

Do not position the equipment such that it is difficult to operate the disconnection device (mains plug).

## EU F-Gas Regulation

This product is exempt from leak checks under Regulation 517/2014/EU. After any servicing of the refrigeration system, SP will provide appropriate documentation to satisfy your requirements as an operator of equipment.

## Hot / Cold Surfaces

At the completion of the evaporation run, sample holders and the IR lamp window (and the IR lamp) may be hot. Take care when opening the evaporator after a run, and allow sample holders to cool (if necessary) before unloading.



**WARNING:** Do not touch the IR lamp window, or the IR lamp, until they have been allowed to cool.

---

## Refrigerant

This product contains flammable refrigerants. The refrigeration circuit is not accessible to the user and shall only be serviced by authorized SP representatives to avoid the risk of ignition due to improper maintenance. Components shall be replaced by authorized components only.

## Power Connections

Connect the EZ-2 to the appropriate mains power supply outlet. Use only the mains supply cord that is provided.



**WARNING:** Extension leads SHALL not be used to connect the EZ-2 or Edwards vacuum pump (Elite only) to the mains power supply outlet.

---

## Maximum Supply Input

This equipment shall be supplied from a power supply no larger than 1500 A.

The pump control cable specification: +/- 25V, 300V insulation.

## Circuit Breaker

To prevent nuisance tripping, the mains power supply to the evaporator shall be fitted with a suitably rated Type-D (or equivalent) mains circuit breaker. This circuit breaker shall be installed near the equipment. If using an earth leakage device, use at least a 30 mA rated unit to avoid trips at start-up.

## Disconnecting the Evaporator

To fully isolate the EZ-2 from the power supply, turn the evaporator off at the power switch and disconnect the plug from the mains supply.



**WARNING:** Risk of Electric Shock. Turning power off at the switch does not fully disconnect the system. Always fully isolate the system by removing the plug from the mains supply before performing any maintenance operation.

---

### Standard / Plus Equipment Layout

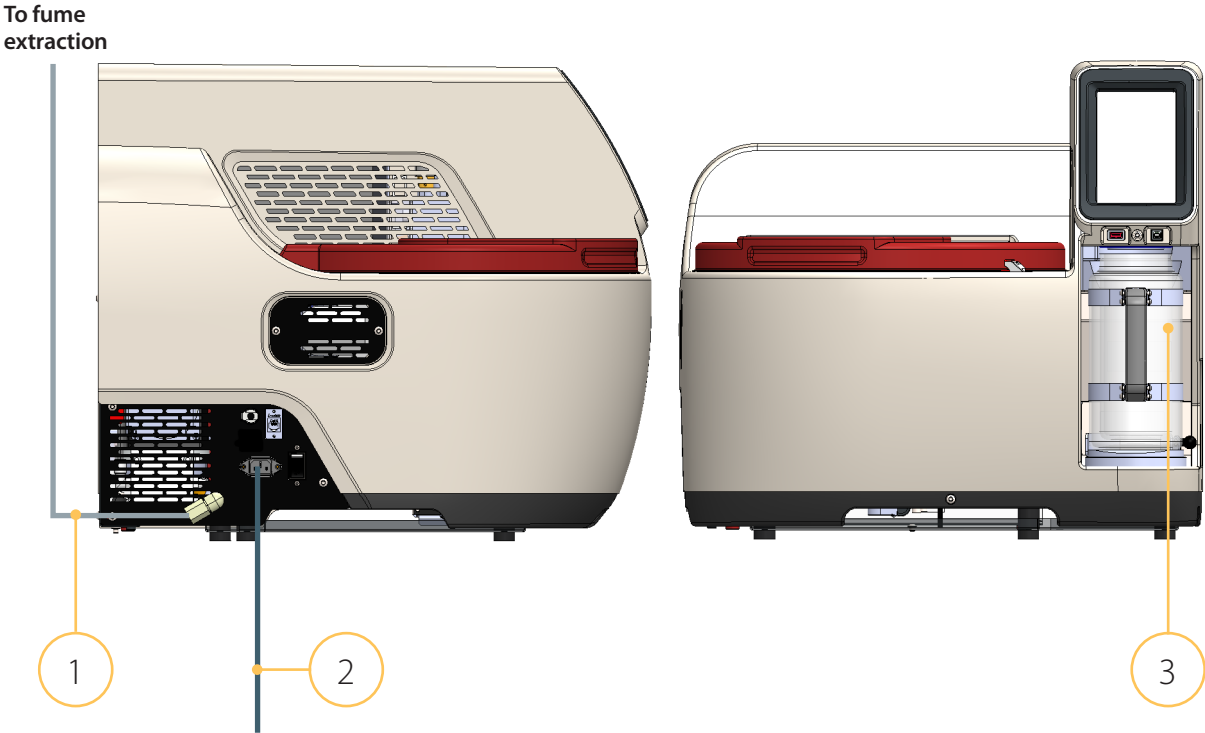

Item	Description
1	Exhaust Line 8 mm OD PTFE fume exhaust hose
2	Mains Supply Cord Region specific mains supply cord
3	Condenser Jar One liter EZ-2 Condenser Jar

## Standard / Plus Equipment Layout (Inert Gas Purge)

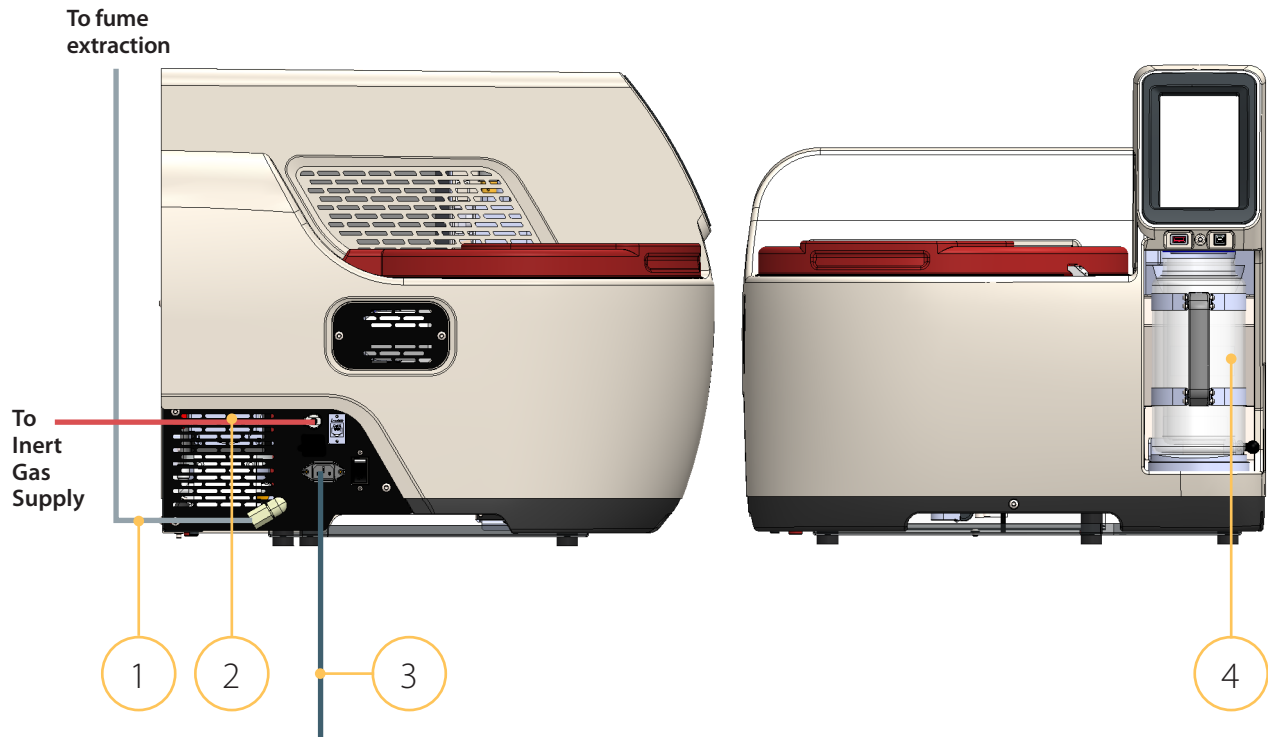

Item	Description
1	Exhaust Line 8 mm OD PTFE fume exhaust hose
2	Inert Gas Supply Hose Connection to Inert Gas supply
3	Mains Supply Cord Region specific mains supply cord
4	Condenser Jar One liter EZ-2 Condenser Jar

### Elite Equipment Layout

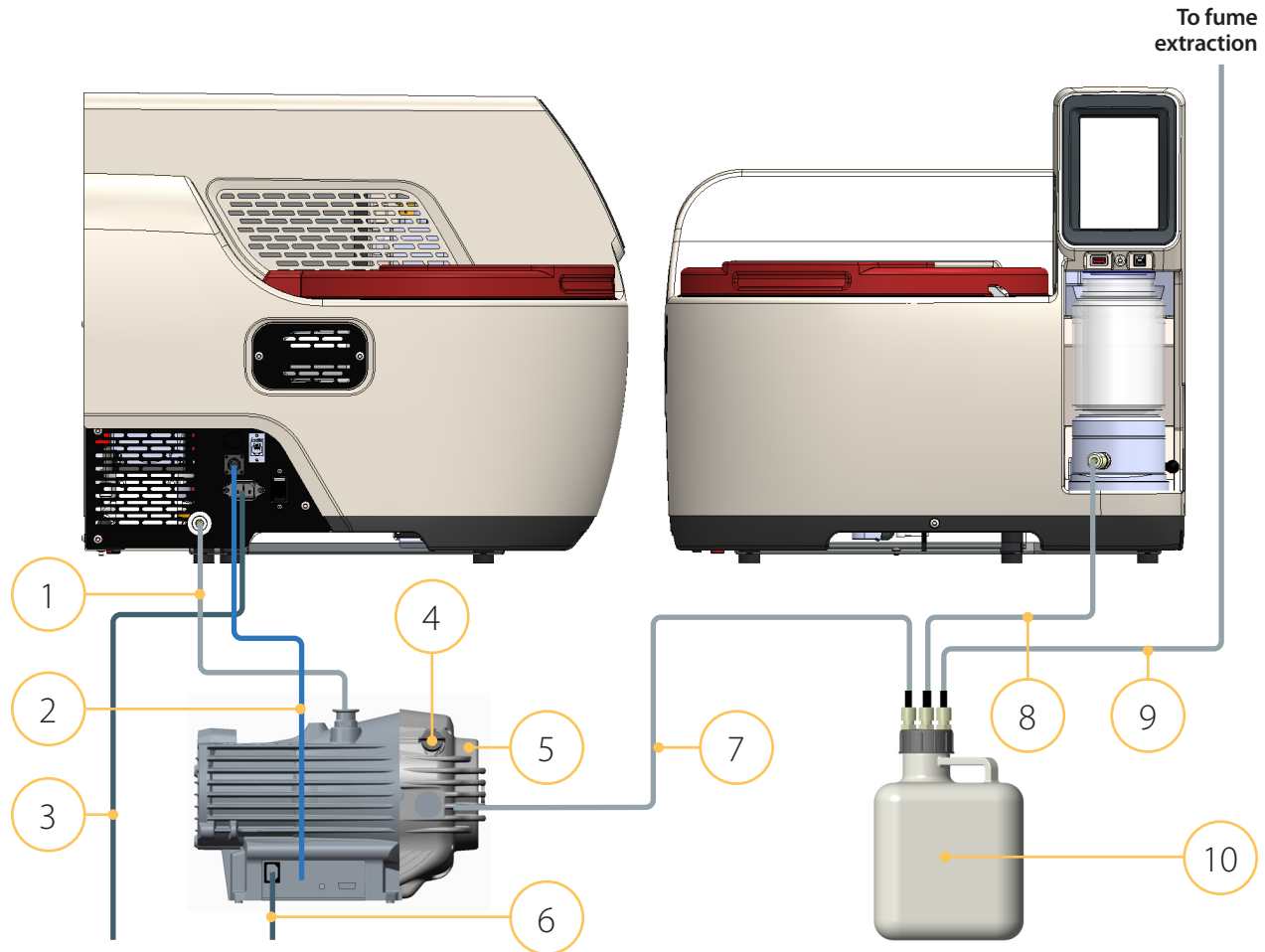

Item	Description
1	Vacuum Hose Two-meter vacuum hose with easy seal Klein flange connectors
2	Vacuum Pump Control Cable Provides control signals to the Edwards nXDS6i vacuum pump
3	Mains Supply Cord (EZ-2) Region specific mains supply cord
4	Ballast Valve Scroll pump ballast valve
5	Vacuum Pump Edwards nXDS6i oil-free scroll pump
6	Mains Supply Cord (Pump) Region specific mains supply cord
7	Pump Exhaust Hose 8 mm OD PTFE pump exhaust hose
8	Waste Solvent Drain Hose 8 mm OD PTFE solvent drain hose
9	Exhaust Line 8 mm OD PTFE fume exhaust hose
10	Waste Solvent Container 5 liter polypropylene waste solvent container

## Elite Equipment Layout (Inert Gas Purge)

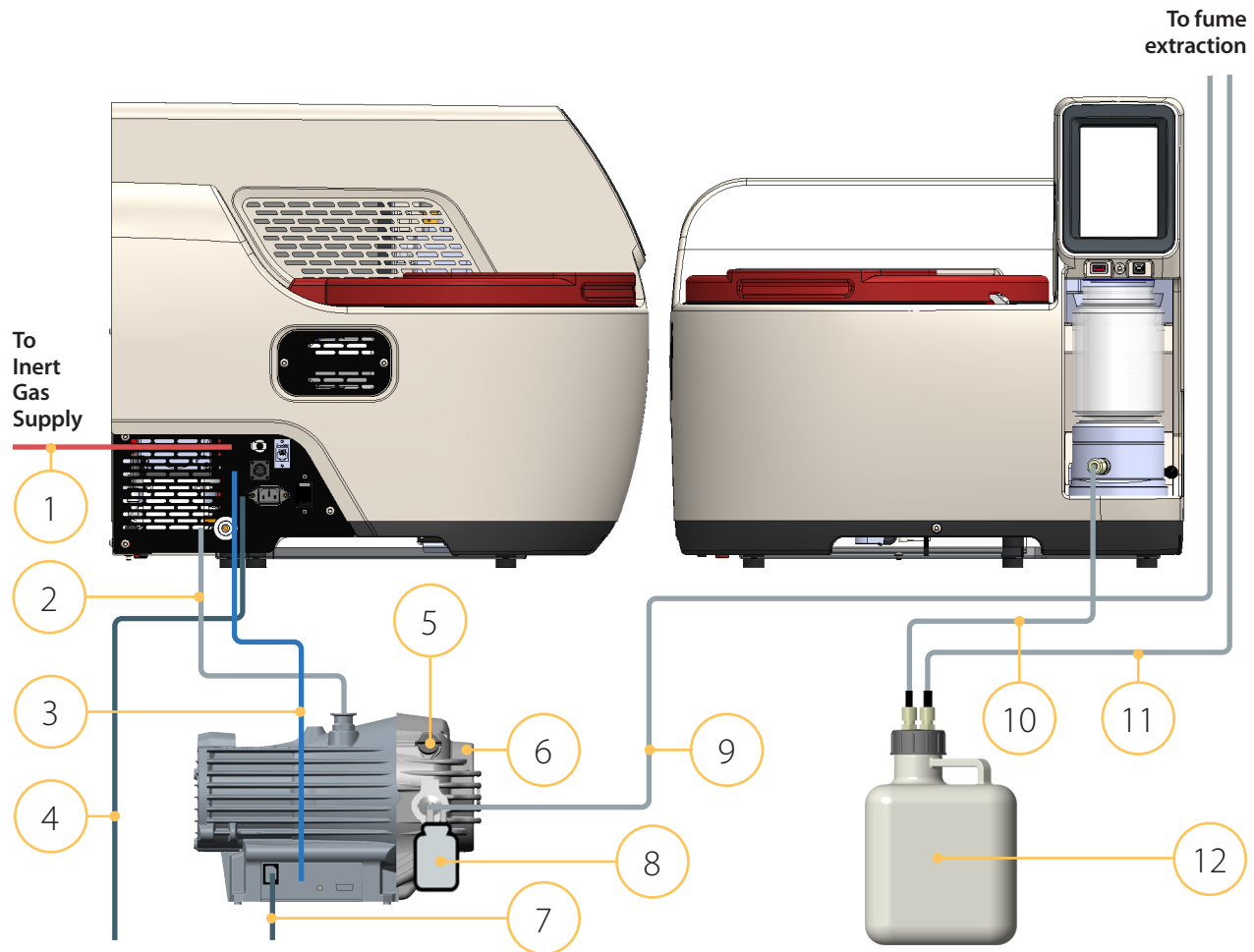

Item	Description
1	Inert Gas Supply Hose Connection to Inert Gas supply
2	Vacuum Hose Two-meter vacuum hose with easy seal Klein flange connectors
3	Vacuum Pump Control Cable Provides control signals to the Edwards nXDS6i vacuum pump
4	Mains Supply Cord (EZ-2) Region specific mains supply cord
5	Ballast Valve Scroll pump ballast valve
6	Vacuum Pump Edwards nXDS6i oil-free scroll pump
7	Mains Supply Cord (Pump) Region specific mains supply cord
8	Pump Catch-Pot Pump catch-pot routed to the laboratory fume extraction
9	Pump Exhaust Hose 8 mm OD PTFE pump exhaust hose
10	Waste Solvent Drain Hose 8 mm OD PTFE solvent drain hose
11	Exhaust Line 8 mm OD PTFE fume exhaust hose
12	Waste Solvent Container 5 liter polypropylene waste solvent container



## System Setup - EZ-2 Standard & Plus

- 1 Fit the Condenser Jar.
- 2 Attach the PTFE exhaust hose (supplied) on to the pump exhaust output on the services panel. Connect the other end of the hose to a suitable laboratory fume extraction system.
- 3 Arrange the exhaust hose so that there are no kinks, constrictions or bends that could impede vapor flow or cause solvent to condense in the hose, resulting in blockage. Double-check all hose connections before continuing. This can cause cooling fans to draw solvent vapor into ventilation ports, resulting in damage to unprotected areas of the evaporator.

Exhaust Hose Connection



- 4 Connect the mains power supply cable.
- 5 Before powering up for the first time, ensure that all parts of the system are installed and/or connected correctly. Perform a safety assessment to ensure that exhaust hoses provide unimpeded flow and are connected to a suitable laboratory fume extraction system.
- 6 Ensure that the environment around the evaporator is free of solvent and acid vapors. Do not use the free space around the evaporator for the storage of vessels containing solvents or acids, even if the evaporator is installed in a fume-cupboard.

**NOTE:** During installation ensure that routing of any piping does not create a safety hazard.

## System Setup - EZ-2 Elite

- 1 Using the Klein flange connectors and the vacuum pipe provided, connect the vacuum pump outlet (1) to the evaporator vacuum inlet (6).
- 2 Connect the pump control cable between the pump (4) and the EZ-2 (5).
- 3 Attach the PTFE exhaust hose (supplied) on to the pump exhaust output (3). Connect the other end of the hose to the waste container, follow instructions in Waste Solvent Container section.
- 4 The Gas Ballast control (2) on the vacuum pump shall be set to position "1".
- 5 Connect the condenser drain (7) to the waste container. Follow instructions in Waste Solvent Container section.
- 6 Attach the PTFE exhaust hose (supplied) on to the waste container. Follow instructions in **Waste Solvent Container** section. Connect the other end of the hose to a suitable laboratory fume extraction system.
- 7 Arrange all hoses so that there are no kinks, constrictions or bends that could impede vapor flow or cause solvent to condense in the hose, resulting in blockage. Double-check all hose connections before continuing.
- 8 Connect the mains power supply cables to the EZ-2 and the pump. Each power cable to be connected to a separate power socket, extension cables shall not be used.
- 9 Before powering up for the first time, ensure that all parts of the system are installed and/or connected correctly. Perform a safety assessment to ensure that exhaust hoses provide unimpeded flow and are connected to a suitable laboratory fume extraction system.
- 10 Ensure that the environment around the evaporator is free of solvent and acid vapors. Do not use the free space around the evaporator for the storage of vessels containing solvents or acids, even if the evaporator is installed in a fume-cupboard.

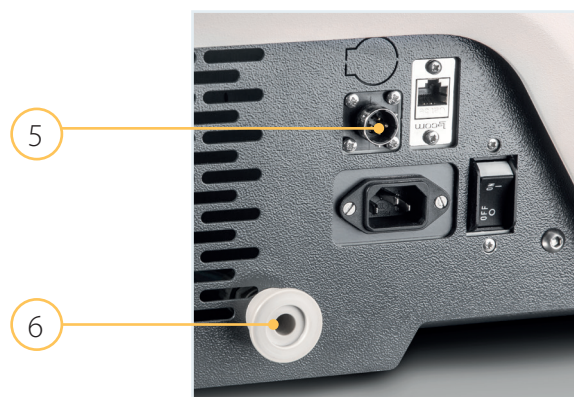
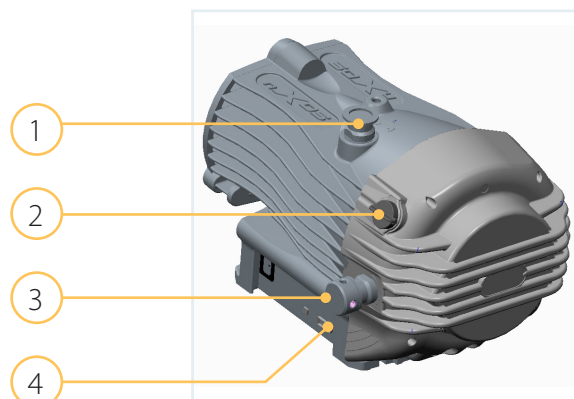

*Elite Condenser Drain*

**NOTE:** During installation ensure that routing of any piping and placement of vacuum pump and waste container do not create a safety hazard.

**The waste solvent container shall be connected to the evaporator via a drain hose at all times while the system is in operation.** The container shall be positioned below the level of the waste outlet, with no kinks, rises or sharp bends in the hose that could impede drainage.

The waste solvent container shall be easily accessible for draining. Check the condition of the container and drain hose regularly.

The end of the waste solvent hose shall not be permitted to become submerged below the level of the waste solvent. Hose retention olive-fittings are provided to ensure that hoses remain secure to the container cap.

Fit the retaining olive over the hose. For the drain hose, position the olive roughly 25 mm from the end of the hose. For exhaust hoses, position the olive roughly 12 mm from the end of the hose. Always ensure that the drain hose is longer than the exhaust hose to prevent drained solvent from being captured by the exhaust hose.

All connections to the container shall be sealed at all times to prevent leakage of vapor and/or solvent into the local environment.

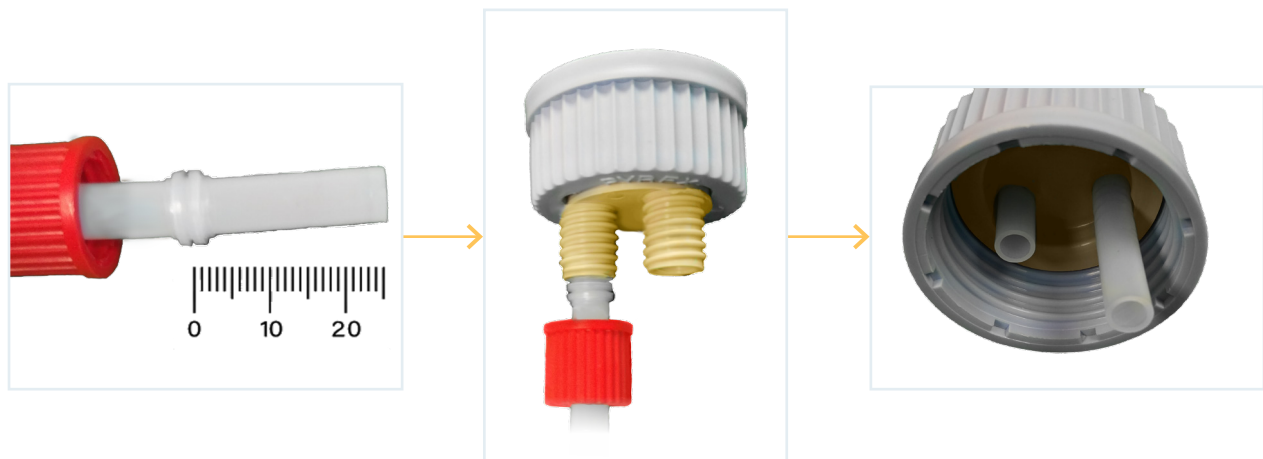

**The waste solvent container shall be emptied before commencing an evaporation run.**

Depending on the method parameters, waste solvent may drain periodically while the evaporator is operating. **Do not start the evaporator if the container is disconnected.**

A 5 liter, sealed polypropylene waste solvent container is supplied. If an alternative container is used, ensure it is compatible with the solvent being processed and can be sealed to prevent release of solvent vapors.

**NOTE: The solvent waste container cap is pre-fitted with a warning label. Do not remove this during installation.**



**CAUTION:** If using an alternative waste container, it shall have a sealed cap and pipe connections to prevent fumes escaping into the local environment. Ensure that the warning label provided is transferred to the new container.

## Installation (Inert Gas Purge System)

EZ-2 evaporators fitted with the Inert Gas Purge (IGP) option shall only be installed and commissioned by an approved SP representative. IGP systems shall be installed in a sufficiently ventilated environment. SP strongly recommend installing IGP systems in a fume-hood.

Inert Gas Purge systems are intended to be used with dry, oxygen-free Nitrogen or Argon only. Contact your local SP representative for advice before attempting to use an alternative inert gas.

Inert Gas Supply Requirements	
Max. Pressure	2 bar g (3 bar absolute)
Min. Pressure	1.5 bar g (2.5 bar absolute)
Flow Rate (nominal)	50 liters/min @ STP
Hose Length	2.5 m
Max. Consumption (Purge)	170 liters approx.
Max. Consumption (Blanket)	88 liters/hour approx.
Connector Type	3/8" BSP female

## Inert Gas Supply

For connection to a pressure-regulated inert gas supply, a hose with a 3/8" BSP female thread is supplied. An adaptor may be required to make the connection to your gas supply. Due to the variety of connector types available, SP do not supply an adaptor.

If an adaptor is required, it must be fitted to the inert gas supply outlet before the evaporator can be commissioned. Without the adaptor, the inert gas purge system will be inoperable and the engineer will be unable to validate its functionality during installation.

## Vacuum Pump Catch-Pot (Elite IGP Only)

IGP-enabled evaporators require the addition of a catch-pot to the vacuum pump exhaust port. The vacuum pump shall be supplied with the exhaust adaptor and catch-pot retaining bracket already fitted. 8 mm PTFE hose shall be used to connect the pump exhaust to the catch-pot, and the catch-pot to the laboratory fume extraction system, as shown.

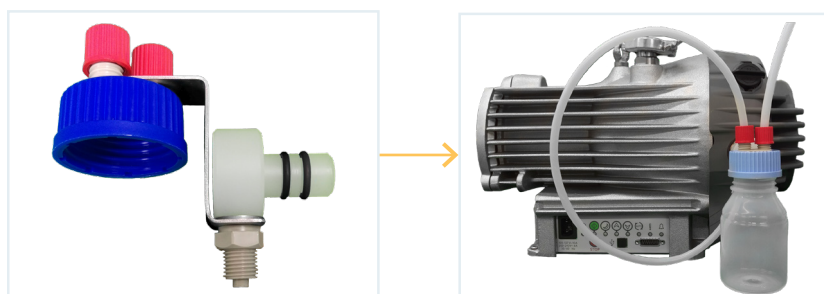

In all other respects, installation of Inert Gas Purge-enabled evaporators should proceed as described for a standard model EZ-2.

## Vacuum Pump (Elite Only)

The vacuum pump supplied with the system is an Edwards nXDS6i high-vacuum scroll pump. The pump is oil-free and requires no routine maintenance by the user.

Vacuum hoses and electrical cables are supplied to connect the vacuum pump to the evaporator. The pump may be positioned beside the evaporator, or below the evaporator on the floor or on a shelf.

## Vacuum Pump Ballast Setting

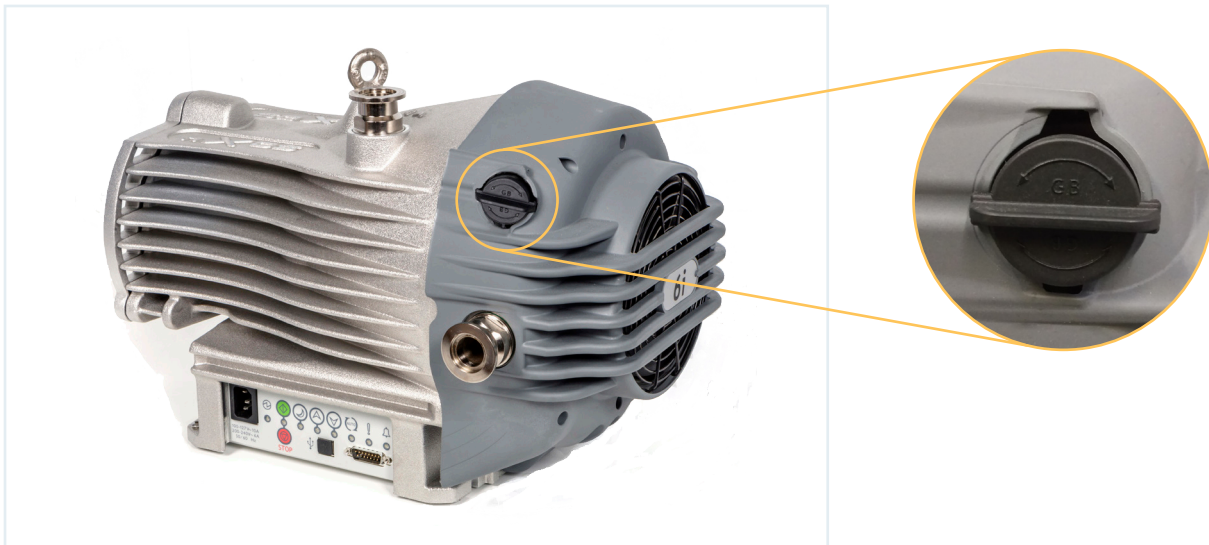

*Gas Ballast setting at position 1*

The “Gas Ballast” control on the vacuum pump shall be set to position “1”. An exhaust port adaptor (not pictured) is supplied; this adaptor will already be fitted to the pump when the system is delivered.

## Alternative Vacuum Sources

SP Genevac EZ-2 evaporators are intended for use with the supplied vacuum pump only. Do not use alternative vacuum equipment (e.g. stand-alone pumps or in-house vacuum systems).

## Exhaust Connection

**Exhaust line(s) shall be connected directly to a suitable laboratory fume extraction system at all times.**

Clear PTFE hose with an outer diameter of 8 mm is supplied.

Once connected, the exhaust line(s) shall be free from kinks, bends and constrictions of any kind (these may cause solvent to condense and block the exhaust line). All exhaust hose connections shall be sealed at all times to prevent leakage of fumes/vapors into the local environment.



**WARNING:** Explosion risk! Connection of the exhaust line(s) to a suitable laboratory fume extraction system or installation in a suitable fume hood is mandatory for safe operation. Minimum ventilation requirements shall be complied with at all times.

**NOTE:** Exhaust lines shall always be individually and directly connected to the laboratory fume extraction system (not 'T-connected' to a shared exhaust line). Exhaust hoses shall be directly connected to a suitable laboratory fume extraction system, even where the evaporator is installed in a fume hood.

## Installation Site Ventilation Requirements

The evaporator is intended for use in a Pollution Degree 2 environment (normally only non-conductive pollution occurs). Suitable local extraction or room ventilation shall be used to ensure that the evaporator is not exposed to potentially flammable atmospheres or corrosive vapors. HCl-compatible evaporators and evaporators fitted with the Inert Gas Purge option require a greater degree of ventilation due to the nature of the samples being processed.

The following values represent the minimum required extraction for the two most commonly used methods of ventilation. Ventilation solutions differ from laboratory to laboratory; if you are considering using a method of ventilation not shown below, make the appropriate conversions where necessary or contact SP for advice.

Requirements in excess of the recommended values may be imposed by local or national regulation; where this is the case, statutory requirements should always take precedence.

**Laboratory fume-extraction systems and fume hoods shall be suitable for use with potentially flammable vapors.**

### Minimum Room Ventilation (Dilution Ventilation)

- Non-HCl-compatible evaporators: 6-8 air changes per hour.
- HCl-compatible and IGP-enabled evaporators: 8-10 air-changes per hour.

### Minimum Local Extraction (Fume Cabinet)

- Non HCl-compatible evaporators: face velocity of 2000-2250 liters per minute.
- HCl-compatible & IGP-enabled evaporators: face velocity of 2550-2850 liters per minute.

## Hazardous Atmospheres & Minimum Room Size

The EZ-2 evaporator and vacuum pump are not intended for installation or use in hazardous or otherwise classified areas/zones where potentially explosive atmospheres may exist. Do not install the evaporator into laboratories or rooms smaller than 4 m x 4 m x 4 m.

## Multiple Evaporators

When placing multiple EZ-2 evaporators together in the same room, ensure that the minimum room size and ventilation requirements are increased proportionately to reflect the number of evaporators. This is not required where multiple evaporators in the same room are contained within fume hoods.

## Re-Circulating Extraction Systems & Fume Hoods

Exhaust vapors from the equipment shall not be allowed to re-circulate into or around the equipment. Do not use re-circulating extraction systems or fume hoods.

Any maintenance or repair of this product, other than that specified within this user manual, should be carried out by an authorized SP representative using SP approved components. SP offer a comprehensive range of service contracts designed to keep your evaporator in top condition.



**WARNING:** Solvent traces may be present inside the evaporator, in the exhaust line and in the drain hose. To avoid contamination, appropriate personal protective equipment (PPE) shall be worn when carrying out maintenance procedures. This is particularly important for HCl-compatible systems.

## Before Use

Check the following before each use:

### Condenser

Check that the condenser jar has been emptied (Standard or Plus) or that the condenser pot has been drained and the waste container has been emptied (Elite). Ensure that the condenser jar / pot is locked with the knob rotated fully left (clock-wise), until the stop position is reached.

### Waste Solvent Container (Elite Only)

Ensure that the waste solvent container has been emptied and re-connected to the drain hose.

### Drain & Exhaust Hoses

Ensure all hose connections are secure. Check that all hoses provide unimpeded draining and that exhaust hoses will ensure vapors are taken safely away from the user and the evaporator.

### Sample Holders

Ensure all sample holders are clean and undamaged.

Visually check the swings and sample holders. Look for any spilled solvent or debris, especially in the sample holder wells. Spilled solvent can cause debris to stick to the sample holders, creating points of increased force during high acceleration that place additional stress on the glassware.

Clean off adhered dirt or debris using a cleaning solvent such as methanol or ethanol. Alternatively, wash in soapy water, then rinse in clean water, or wash in a dishwasher at 90°C. Sample holders should be cleaned regularly, and always following any incident that involves glass breakage or solvent spillage.

**NOTE:** Sample holder colors may vary. Repeated use of sample holders with strong acids may cause color fading over time. This is normal, and does not affect the performance or integrity of the sample holders.

### Rotor

Before use, and before loading sample holders, gently spin the rotor to ensure it is unobstructed and securely attached. If you notice any wobbling or misalignment of the rotor, immediately stop using the evaporator and contact SP for advice.



## After Use

Where possible, the condenser should be defrosted and drained automatically at the end of every evaporation run. Where this is not possible, a defrost and drain cycle should be initiated manually at the end of each run (unless using TFA or strong acids - see **Defrost & Drain** in the **Operation Manual**). Visually check that the condenser has fully drained - Elite only.

Dispose of waste solvents in accordance with local environmental regulations.

## Weekly Checks

Inspect the following items weekly and clean or replace defective parts as necessary:

- Lid Seal
- IR Lamp Window
- Sample Holders
- Solvent Hose connections (exhaust/waste)
- Waste Solvent Container connections and seals (Elite Only)

## Following Glassware Breakage

After any incident involving glassware breakage:

- Use a vacuum cleaner and/or dust-pan and brush to remove all glass debris from the vacuum chamber.
- Check for glass fragments in the condenser jar.
- Clean glass fragments out of condenser jar after emptying.
- Dry the system using absorbent paper towels. Take care to avoid build-up of loose fibres around seals and other sensitive areas.
- Perform a system test.
- Contact SP or your local distribution partner as required by system test.

## Use or Spillage of Toxic / Hazardous Substances

After use or spillage of toxic or hazardous substances, an evaporation run using ethanol or methanol shall be performed to clean and decontaminate the system.



**WARNING:** Some of the solvents approved for use with the EZ-2 may be subject to occupational exposure limits. Due to the function of the product, a small amount of solvent vapor may be present in the evaporation chamber at the end of the run. Appropriate protective equipment shall be worn when working with harmful solvents, in accordance with national regulations.

## After Sample Holder Damage / Rotor Crash

After any incident that results in damage to sample holders or the walls of the evaporation chamber, including crashes and misloading, **immediately stop using the evaporator**. Contact SP for a safety evaluation before allowing the evaporator to be used.

Any sample holders / swings involved in the incident shall also be quarantined until checked for damage.

## General Cleaning

Establishing a schedule for periodic cleaning is recommended. Weekly cleaning is suggested, however the required frequency of cleaning will depend on the frequency of use and the nature of the solvents being evaporated. **Wear personal protective equipment when cleaning as indicated by risk assessment.**

When selecting cleaning solutions, be aware of the possibility of reaction with solvents or analytes that may have been processed in the evaporator. If in doubt, contact SP for advice.

### External Surfaces

- Clean using paper wipes or lint-free cloth dampened with a mild detergent solution.
- If necessary, use methanol or ethanol sparingly as a cleaning solvent.

### Rotor

- Ensure that clean, undamaged PTFE washers are present at all rotor positions
- Ensure that all sample holders are able to swing freely on the rotor pins. Clean or remove any residue or debris that could hinder free movement of the swings.

### Interior Surfaces (Lid/Chamber)

- Visually check the interior surfaces of the vacuum chamber and lid. Remove any splashes, residue or other debris and wipe away any condensed solvent. Pay particular attention to the surface of the lid that contacts the lid seal.
- Ethanol or Methanol may be used as a cleaning solvent.
- If required, Acetone may be used sparingly as a cleaning solvent for interior surfaces. Take care to avoid all contact with the lid seal and IR lamp window (Ketone solvents will damage the seals).

### Lid Seal

- Clean using paper towels or lint-free cloth dampened with a mild detergent solution.
- If necessary, use methanol or ethanol sparingly as a cleaning solvent. Do not use acetone or other ketone solvents to clean the lid seal.

### IR Lamp Window

- Remove all traces of solvent, debris and any residue/deposits from the glass.
- If necessary, use methanol or ethanol sparingly as a cleaning solvent. Do not use acetone or other ketone solvents to clean the IR lamp window as they may damage the seals.
- To prevent skin oils and other contaminants from adhering to the glass, always wear gloves when cleaning the lamp window.



**CAUTION:** At the completion of an evaporation run the lamp window may be hot. Do not touch the lamp window until they have been allowed to cool.

---

## Cleaning HCl-Compatible Evaporators

For HCl-compatible systems, cleaning after every use is strongly recommended to ensure correct operation and long system life.

## Cleaning & TFA

If, after evaporating TFA, you do not intend to use the evaporator for several hours, a “rinse” run shall be performed immediately to eliminate any residual TFA left in the system. Use an Aqueous method with a minimum of 200 ml of Methanol or similar solvent.



**CAUTION:** Ketone solvents will rapidly degrade polymer materials. Ketone solvents shall not be permitted to contact the door seals or IR lamp window.



**WARNING:** The condenser operates at temperatures in excess of -50 to +60°C. Allow the condenser to reach room temperature before conducting any operation near the condensing coil. Note that some solvents may still be liquids at temperatures below 0°C. Always wear suitable personal protective equipment as indicated by risk assessment.

## Cleaning Inert Gas Purge-Enabled Evaporators

A ‘dry’ aqueous evaporation run (swings or one-part sample holders only, no samples or solvents, using the “Aqueous” method) shall be performed for a minimum of one hour before disabling the Inert Gas Purge system to ensure that all traces of low flashpoint solvents are removed.

A reminder will be displayed on the screen whenever a user attempts to disable Inert Gas Purge.

Please confirm that you have completed an Aqueous run to clean the system before disabling Inert Gas Purge. See Manual.

NO

YES

In all other respects, cleaning should be performed as described in “General Cleaning”.

## Opening the Lid without Power

In the event of a power failure or critical error that prevents operation of the evaporator, it may be necessary to retrieve samples or decontaminate the chamber prior to the arrival of a service engineer. To enable this, it is possible to open the chamber lid when the system is not powered.



**WARNING:** Moving parts hazard. To avoid risk of injury, make sure the rotor is stationary before opening the lid. Following a power failure, wait ten minutes for the rotor to stop before opening the lid.

- 1 Wait until the rotor has stopped spinning and the chamber has vented to atmospheric pressure. This may take up to ten minutes following a power failure or critical error.

**NOTE:** Slow spin-down ensures sample integrity by maintaining centrifugal force until the chamber pressure has increased above the solvent boiling point.

- 2 Unplug the power cable to isolate the system from the mains power supply. This ensures safety should mains power be unexpectedly restored.
- 3 Using a M2.5 Allen key, remove the grub screw for the top of the latch.
- 4 Insert a cable tie into the hole and drop to the bottom of the shaft. Orientation of the cable tie is so that the square section at the top points towards the condenser pot.
- 5 Apply pressure and insert the cable tie 10 mm further into the latch.
- 6 Manually lift the lid.

**NOTE:** After the access is complete, refit the grub screw into the top of the latch and tighten until resistance is encountered.

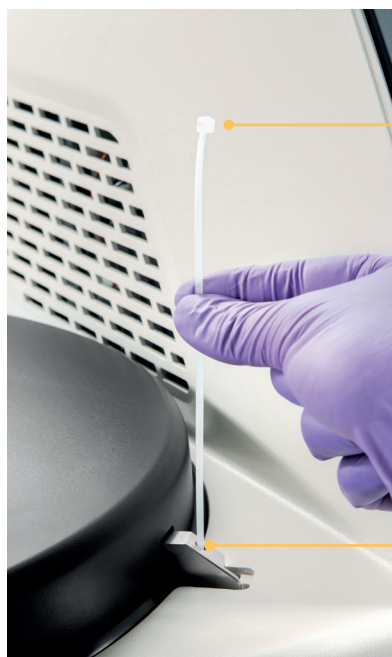

Orientation of the cable tie

Latch hole

## Infra-Red (IR) Lamp Replacement

The IR lamp provides heat to the sample swings and is user-replaceable.



**WARNING:** The IR lamp may be hot if the evaporator has been operating. To avoid the risk of burns, switch off the evaporator and allow it to cool before attempting to replace the IR lamp.

**NOTE:** Replacement lamp bulbs are supplied in protective boxes. Wear clean gloves when handling and leave the bulb in the box until you are ready to install it.

**1 Unplug the power cable to isolate the system from the mains power supply.**

- 2** Remove the lamp service panel on the left hand side of the system by unscrewing the two M4 retaining screws.



- 3** Disconnect the lamp connector from the back of the lamp.

*Disconnect the lamp connector by pulling gentle in the direction of the arrow **A***

*Slide the Lamp out of the connector in the direction of the arrow **B***

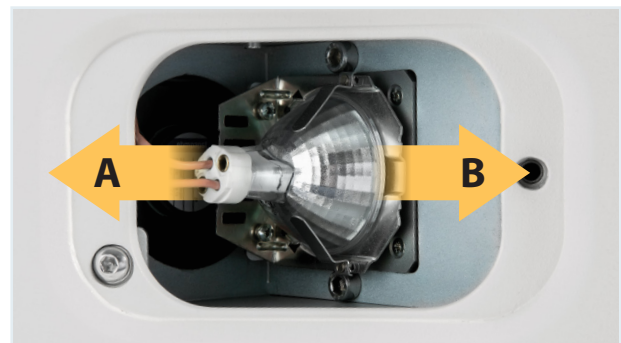

- 4** Remove the lamp by sliding out of the holder towards the front of the system.
- 5** When replacing the lamp bulb, a small amount of manual manipulation may be required to seat the lamp correctly in the fitting.
- 6** When refitting the lamp service panel ensure that it is orientated with the ventilation holes towards the front of the system.
- 7** Reset the Lamp Hours Used on the Settings screen.

**NOTE:** Dispose of used IR lamps in accordance with local laws and regulations.



**CAUTION:** Use only lamps that are supplied by SP. Do not use unapproved IR lamps.

## Lid Seal

### Removing the Lid Seal

Open the lid and then unplug the power lead to isolate the system from the mains power supply.

Starting at the latch point, grip the seal between thumb and fingers and gently lift up from the chamber.

Repeat as necessary around the chamber to detach the lid seal.

### Fitting the Lid Seal

**NOTE:** Please read the entire procedure before attempting to replace the seal.

- 1 Open the lid and then unplug the power lead to isolate the system from the mains power supply.
- 2 Place the seal on the system aligning the small recess in the outer lip with the latch slot.
- 3 Starting at the back, grip the seal to compress the outer flap and insert the lower edge between the chamber and the moulding/hinge plate. Work from the center, fitting both sides of the back of the chamber before moving to the front.
- 4 Ensure that the outer lip does not rest on the top of the moulding.
- 5 Once the seal is in place then move around the seal gently pushing on the top of the seal to ensure that it is sitting flat and level.
- 6 Once you have confirmed that the seal is secure, turn on the system and start a system test to ensure that the seal is working correctly.



*Hand position for seal removal*



*Lid seal alignment with latch slot*



## Lid Seal Troubleshooting

After fitting the new seal, you may encounter one of the following common issues:

### **Vacuum Errors**

If, after fitting the new seal and performing a system test run, the evaporator displays vacuum errors, the seal may not be correctly fitted. Check the seal to ensure that it is flush to the chamber all the way around. Ensure that the seal face is flat to the lid surface all the way around.

### **Failure to Close**

If, after fitting the new seal, the lid fails to close properly, then check to ensure the seal is flat and level all the way around the chamber. Check that the seal is correctly orientated to ensure that the outer seal flap is not block the latch hole.

### **No 'Grab' when Vacuum Applied**

If the lid closes correctly, but fails to 'grab' to the chamber when vacuum is applied, try pushing down on the lid during the start-up sequence. This will help the seal bed in. Allow a short test run to bed the seal in, then retry and see if the lid grabs correctly.

If these methods do not resolve the problem, contact your local SP representative for assistance.

## Condenser Seal

### Removing the Condenser Seal

- 1 Unplug the power lead to isolate the system from the mains power supply and then remove the condenser jar.

**NOTE:** If removing an Elite pot, you will also need to remove the pot connection, pull on the connector to disconnect.

- 2 Grip the seal between thumb and fingers and gently pull down.

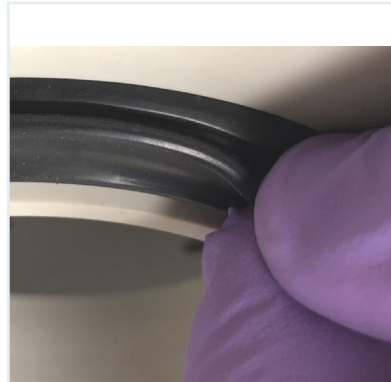

*Hand position for seal removal*



**CAUTION:** Condenser coil could be cold, do not insert fingers into the central aperture.



**CAUTION:** Solvents could be retained on the condenser seal, use appropriate PPE when changing the condenser seal.

### Fitting the Condenser Seal

- 1 Hold the seal with the flange at the bottom.
- 2 Push the seal onto the manifold.
- 3 Ensure that the outer lip does not rest on the top of the moulding.
- 5 Once the seal is in place then move around the seal gently pushing on the bottom of the seal to ensure that the seal face is flat and above the level of the central aperture.
- 6 Refit the condenser jar.

**NOTE:** If fitting an Elite pot, you will need to insert the pot connection, align the plug and push gently into position.

- 7 Once you have refitted the jar, turn on the system and start a system test to ensure that the seal is working correctly.



*Condenser seal alignment with flange towards the bottom*



## Condenser Seal Troubleshooting

If, after fitting the new seal and performing a system test run, the evaporator displays vacuum errors, the seal may not be correctly fitted. Check the seal to ensure that the seal face is flat and above the level of the central aperture.



## Maintenance (Inert Gas Purge)

EZ-2 evaporators fitted with the Inert Gas Purge system have additional maintenance requirements that must be adhered to, to ensure safe operation and long system life.

### Before / After Use

Check that all hose connections, including the Inert Gas connection, are secure before and after each use of an Inert Gas Purge system.



**WARNING:** Asphyxiation hazard. Inert gas may leak from the evaporator during operation of the Inert Gas Purge system. To avoid the risk of asphyxiation, the minimum ventilation requirements shall be complied with at all times. All hose connections shall be secured before use.

For cleaning requirements, refer to ***Cleaning Inert Gas Purge-enabled Evaporators*** earlier in this manual.

### Mandatory Maintenance

Evaporators fitted with Inert Gas Purge require mandatory replacement of internal flame arrestors every twelve months to ensure safe operation. HCl-compatible Inert Gas Purge-enabled evaporators require inspection and replacement every six months.



**WARNING:** Flame arrestors on Inert Gas Purge-enabled systems are not user serviceable. Flame arrestors must be replaced by a SP-approved representative every twelve months (or every six months for HCl-compatible evaporators). **Failure to adhere to this requirement may result in the evaporator becoming unsafe for use.**

Contact SP for more information on the range of available service contracts.

Updates to the operating system of the EZ-2 may be offered periodically. When a software update is received, it must be transferred to a USB storage device. The USB storage device can then be plugged into the USB-A port located under the touch-screen display.



To update the software:

- 1 On a freshly formatted USB storage device, create a folder named "EZ2".
- 2 Copy the software upgrade file into the 'EZ2' directory.
- 3 Switch off the EZ-2 evaporator.
- 4 Wait 10 seconds.
- 5 Insert the USB storage device into the USB-A port under the touch screen.
- 6 Switch on the EZ-2 evaporator.
- 7 The system will prompt the user with to confirm the installation, tap 'YES' to install the displayed version.
- 8 Software will take approximately five minutes to install.
- 9 The system will automatically start the new software when installation is complete.

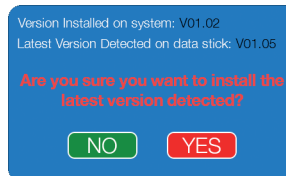

**NOTE:** Do not turn on the evaporator with the USB-B cable connected.

**NOTE:** Only dedicated USB storage devices (USB flash drives etc.) are suitable for use with the evaporator. Cell-phones and similar multi-purpose devices that function as USB storage devices are not supported.

**NOTE:** For reliable operation, use a USB device that does not have protection or encryption, and is not partitioned. USB devices must be formatted as FAT32 and allocation unit size of 4096 bytes to be used with EZ-2 evaporators.

## Faults & Errors

In the unlikely event of a problem occurring with your EZ-2 evaporator, an alarm will be displayed. There are two categories of alarm: critical and non-critical.



When an error occurs, a red alarm icon will appear in top right hand corner of the run screen.

To view error reports before they are automatically displayed, tap the alarm icon. Once the error report has been viewed and acknowledged.

## Non-Critical Errors

If a non-critical error occurs before starting an evaporation run, the evaporator may not allow the user to start the evaporation run until the error is rectified. Non-critical errors will no longer be displayed once the error condition is resolved.

If a non-critical error occurs during an evaporation run, the evaporator will continue to operate. Depending on the nature of the error, efficiency may be reduced (for example, the failure of the IR lamp).

## Critical Errors

Critical errors may be viewed and acknowledged, but may re-occur until resolved and will in some cases prevent evaporation runs from starting. Critical errors cannot be resolved by the user and require intervention by a SP-approved service engineer before the evaporator may be operated.

Should a critical error occur while an evaporation run is in progress, the evaporator will stop automatically. Once the rotor has stopped, the error report will be displayed on the screen.

## Error Logging

All errors are logged by the evaporator software. Errors may be viewed in more detail on the Alarm History screen.

## System Audio / Visual Alerts

Audio	
Evaporator Stopped	Three short beeps. Repeats every minute until user intervenes.
Shutdown Errors	Repeated beeping until user intervenes
Visual	
Evaporator Stopped	Condenser back-light flashes three times, repeats every ten seconds.
Error Encountered	Condenser back-light flashes for one second on/off.

### Providing Error Logs to SP Service

In the unlikely event of a system failure or other problem, you may be asked to provide your local SP service department with the error log.

To provide error logs to SP:

- 1** Insert a USB stick into the USB-A port on the front of the evaporator
- 2** Go to the File menu
- 3** Tap the "Save All" icon to enter the page
- 4** Tap "Save All" to start the process
- 5** Remove the USB stick and send the **/EZ2/** directory to SP

Symptom	Cause	Rectification
Lid will not open	No power	Ensure power cable is connected and power switch is set to "ON".
	Lid lock failure	To retrieve samples, refer to the EZ-2 Installation & Maintenance Manual procedure "opening the lid without power". Contact your SP service provider.
Excessive vibration at start-up	Sample holder imbalance	Stop evaporator. Check all samples and sample load out to ensure rotor is correctly balanced.
	Uneven evaporation	Check condition of sample holders. Ensure method used is appropriate for the application.
	SampleGenie seal leak	Check condition of SampleGenie vial seals and replace if necessary.
No vacuum / vacuum leak errors	Lid seal (detachment, slippage etc.)	Check that the lid seal is clean and correctly fitted around the chamber.
	Vacuum pump not operating	Check connections to vacuum pump - Elite only.
Excessive duration of evaporation run	Incorrect method	Ensure selected method is appropriate for the application
	Incorrect method settings	Review method settings for accidental changes. Ensure custom method settings are appropriate for the application.
Samples not drying	Incorrect method	Ensure selected method is appropriate for the application.
	Incorrect method settings	Review method settings for accidental changes. Ensure custom method settings are appropriate for the application.
	IR lamp failure	Review alarm history. Check IR lamp and replace if necessary.
	Application issue	Check whether fats/oils/contamination may be causing a surface layer to form on samples.
	Sample volume too low	Very small sample loads can cause AutoStop detection problems. Increase the volume of solvent, or end the method stage via Elapsed Time option.
Excessive odour	"Reduce Odour" settings ineffective	For high boiling point solvents, set lower pressure.
Waste solvent volume less than expected	Exhaust back-pressure	Ensure exhaust hose is free from kinks, constrictions and/or blockages.
	Condenser not defrosting	Initiate manual defrost and drain for a minimum of 30 minutes.
	Condenser not draining (Elite only)	Contact your SP service provider.
Evaporator gets hot	High temperatures created by high solvent load	The temperature of air being blown out of the vents may reach 70°C. This is normal and is not a cause for concern.
	Internal fan failure	Contact your SP service provider.
Vial breakage	Poor vial quality	Use only high-quality glassware from reputable manufacturers
	Damaged vial	Do not use scratched or chipped vials. Replace all vials periodically.

This page intentionally left blank.

## Appendix 1 - Fume Hood Compatibility

If installing the EZ-2 into a fume hood, please note the following dimensions to ensure compatibility.

SP recommend airflow testing after installation to ensure that operation of the fume hood is not impaired by the presence of the evaporator. Exhaust hoses shall be connected directly to a suitable laboratory fume extraction system, even where the evaporator is installed in a fume hood.

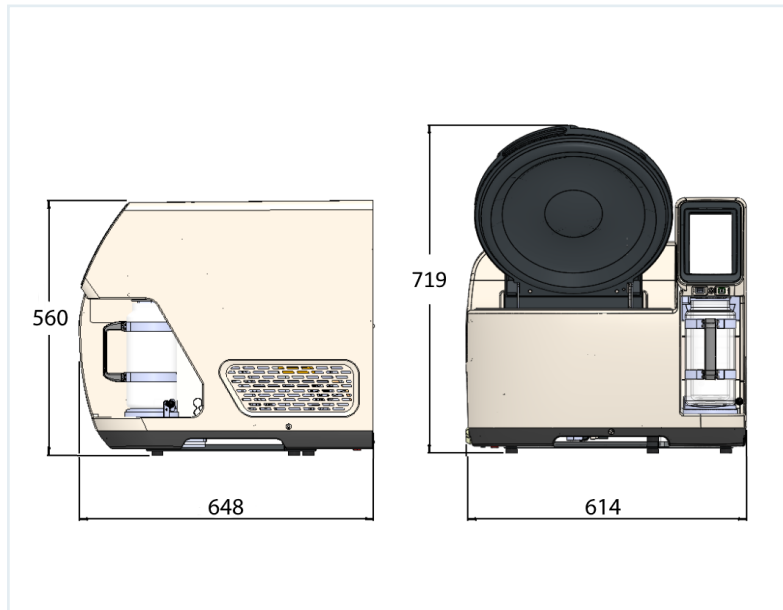

Read these instructions carefully before operating the evaporator and keep them near the system for ease of reference. Your attention is drawn, in particular, to the **Safety** and **Installation & Commissioning** sections.

These instructions are correct at the time of going to press and may be subject to change without notice. Some of the features and software functions described within this manual may not apply to equipment manufactured before this manual's publication date; this includes systems that have been upgraded.

No part of these instructions may be reproduced in any form or be processed, duplicated or distributed by electronic or other means without the express written permission of SP.

Should you need to contact SP for assistance, please use one of the contact methods shown. Please have the equipment serial number and any other pertinent information to hand.

This equipment should not be discarded in your regular waste stream. Contact your representative or SP for correct disposal instructions.

Within the EU, it is SP's responsibility under the WEEE Directive to provide for the recycling of SP products.



*Bel-Art | FTS | Genevac | Hotpack | Hull | i-Dositecno | Service | VirTis | Wilmad-LabGlass*

**Genevac Ltd.**

The Sovereign Centre  
Farthing Road  
Ipswich, Suffolk  
IP1 5AP, United Kingdom  
Sales: +44 (0) 1473 240000 | [sales@scientificproducts.com](mailto:sales@scientificproducts.com)  
Service: +44 (0) 1473 243000 | [service@scientificproducts.com](mailto:service@scientificproducts.com)  
Application Support: [applications@scientificproducts.com](mailto:applications@scientificproducts.com)

**Scientific Products**

3538 Main Street  
Stone Ridge, NY  
12484, USA  
Sales: +1 845.267.2211 | [sales@scientificproducts.com](mailto:sales@scientificproducts.com)  
Service: +1 877.548.4666 | [service@scientificproducts.com](mailto:service@scientificproducts.com)  
Application Support: [applications@scientificproducts.com](mailto:applications@scientificproducts.com)

