

# **PowerLite<sup>®</sup> Home Cinema 5040UB/5040UBe User's Guide**



---

# Contents

<b>PowerLite Home Cinema 5040UB/5040UBe User's Guide .....</b>	<b>9</b>
<b>Introduction to Your Projector .....</b>	<b>10</b>
Projector Features.....	10
Product Box Contents.....	11
Additional Components .....	12
Optional Equipment and Replacement Parts.....	13
Warranty and Registration Information .....	14
Notations Used in the Documentation .....	14
Where to Go for Additional Information .....	15
Additional Projector Software and Manuals.....	15
Projector Part Locations .....	16
Projector Parts - Front/Top .....	17
Projector Parts - Rear .....	18
Projector Parts - Base.....	19
Projector Parts - Control Panel .....	20
Projector Parts - Remote Control.....	21
<b>Setting Up the Projector .....</b>	<b>24</b>
Projector Placement.....	24
Projector Setup and Installation Options .....	24
Projection Distance.....	26
Projector Connections .....	29
Removing and Attaching the Terminal Cover .....	29
Connecting to an HDMI Video Source .....	30
Connecting to Computer Sources.....	31
Connecting to a Computer for VGA Video.....	31
Connecting to a Computer for HDMI Video .....	31
Attaching and Removing the Cable Clips .....	32
Connecting to External Speakers .....	32
Connecting to a Trigger Out Port.....	33
Installing Batteries in the Remote Control .....	34

<b>Using the Projector on a Network .....</b>	<b>36</b>
Wired Network Projection .....	36
Connecting to a Wired Network .....	36
Selecting Wired Network Settings .....	37
Wireless Network Projection .....	39
Installing the Wireless LAN Module .....	40
Selecting Wireless Network Settings Manually .....	41
Wireless LAN Menu Settings .....	44
Restricted IP Addresses .....	45
Using a QR Code to Connect a Mobile Device .....	45
Searching for a Wireless Network .....	47
Selecting Wireless Network Settings in Windows .....	49
Selecting Wireless Network Settings in OS X .....	49
Enabling WPA or WPA2 Security .....	49
Wireless Security Menu Settings .....	50
Selecting External Network Detection Settings .....	51
<b>Using Basic Projector Features .....</b>	<b>53</b>
Turning On the Projector .....	53
Using the Home Screen .....	54
Turning Off the Projector .....	56
Viewing 3D Images .....	57
Pairing the 3D Glasses with the Projector .....	58
Charging the 3D Glasses .....	59
3D Viewing Range .....	61
Selecting the Language for the Projector Menus .....	61
Adjusting the Image Height .....	62
Adjusting the Image Position Using Lens Shift .....	63
Image Shape .....	65
Correcting Image Shape With the Keystone Buttons .....	65
Resizing the Image with the Zoom Feature .....	65
Focusing the Image with the Lens Button .....	66
Remote Control Operation .....	67
Selecting an Image Source .....	68

Projection Modes .....	70
Changing the Projection Mode Using the Menu .....	70
Image Aspect Ratio .....	71
Changing the Image Aspect Ratio .....	72
Available Image Aspect Ratios .....	72
Color Mode.....	73
Changing the Color Mode.....	73
Available Color Modes.....	74
Turning On Auto Iris.....	74
<b>Adjusting Projector Features .....</b>	<b>76</b>
Shutting Off the Picture Temporarily .....	76
Using Picture in Picture .....	76
Available Picture in Picture Options.....	77
Adjusting the Color Convergence (Panel Alignment) .....	78
Adjusting the Color Tone (Color Uniformity).....	81
Projector Security Features.....	83
Locking the Projector's Lens Settings and Buttons.....	83
Unlocking the Projector's Buttons .....	85
Installing a Security Cable .....	85
Saving Settings to Memory and Using Saved Settings .....	85
Saving the Lens Position and Using Saved Lens Positions.....	86
<b>Using WirelessHD .....</b>	<b>89</b>
WirelessHD Transmitter Parts.....	89
WirelessHD Transmission Range .....	91
WirelessHD Remote Control Operation.....	93
Connecting the WirelessHD Transmitter .....	94
Viewing WirelessHD Content .....	95
Switching WirelessHD Sources.....	96
<b>Adjusting the Menu Settings .....</b>	<b>98</b>
Using the Projector's Menu.....	98
Image Quality Settings - Image Menu .....	99
Input Signal Settings - Signal Menu.....	104
Projector Feature Settings - Settings Menu.....	108

Projector Setup Settings - Extended Menu.....	113
Projector Network Settings - Network Menu.....	116
Projector Information Display - Info Menu .....	117
Event ID Code List.....	118
Projector Reset Options - Reset Menu .....	120
<b>Maintaining and Transporting the Projector .....</b>	<b>122</b>
Projector Maintenance .....	122
Cleaning the Lens.....	122
Cleaning the Projector Case.....	123
Cleaning the 3D Glasses .....	123
Air Filter and Vent Maintenance .....	124
Cleaning the Air Filter.....	124
Replacing the Air Filter .....	127
Projector Lamp Maintenance.....	129
Replacing the Lamp .....	130
Resetting the Lamp Timer.....	133
Replacing the Remote Control Batteries .....	134
Transporting the Projector.....	136
<b>Solving Problems .....</b>	<b>138</b>
Projection Problem Tips .....	138
Projector Light Status .....	139
Solving Image Problems .....	142
Solutions When No Image Appears.....	142
Solutions When "No Signal" Message Appears.....	143
Displaying From a PC Laptop .....	144
Displaying From a Mac Laptop .....	144
Solutions When "Not Supported" Message Appears .....	144
Solutions When Only a Partial Image Appears .....	145
Solutions When the Image is Not Rectangular .....	145
Solutions When the Image Contains Noise or Static .....	146
Solutions When the Image is Fuzzy or Blurry .....	147
Solutions When the Image Brightness or Colors are Incorrect .....	147
Solutions When a 3D Image Does Not Display Correctly .....	148

Solutions When a WirelessHD Source Does Not Display Correctly.....	149
Solving Projector or Remote Control Operation Problems .....	150
Solutions to Projector Power or Shut-Off Problems .....	150
Solutions to Problems with the Remote Control.....	151
Solutions to Password Problems .....	152
Solutions to Panel Alignment Problems.....	152
Solutions When Using HDMI Link.....	153
Solutions When Wireless Authentication Fails .....	153
Where to Get Help.....	153
<b>Technical Specifications .....</b>	<b>155</b>
General Projector Specifications .....	155
Projector Lamp Specifications.....	156
Remote Control Specifications .....	157
Projector Dimension Specifications.....	157
Projector Electrical Specifications .....	157
Projector Environmental Specifications.....	158
Projector Safety and Approvals Specifications.....	158
Supported Video Display Formats.....	159
<b>Notices .....</b>	<b>162</b>
Recycling.....	162
Important Safety Information .....	162
Important Safety Instructions.....	162
Restriction of Use .....	165
List of Safety Symbols (corresponding to IEC60950-1 A2).....	166
FCC Compliance Statement.....	169
Open Source Software License.....	170
Trademarks .....	219
Copyright Notice.....	220
A Note Concerning Responsible Use of Copyrighted Materials.....	220
Copyright Attribution .....	221





---

# PowerLite Home Cinema 5040UB/5040UBe User's Guide

Welcome to the PowerLite Home Cinema 5040UB/5040UBe *User's Guide*.

For a printable PDF copy of this guide, [click here](#).

---

# Introduction to Your Projector

Refer to these sections to learn more about your projector and this manual.

[Projector Features](#)

[Notations Used in the Documentation](#)

[Where to Go for Additional Information](#)

[Additional Projector Software and Manuals](#)

[Projector Part Locations](#)

## Projector Features

The PowerLite Home Cinema 5040UB and 5040UBe projectors include these special features:

### **Bright, high-resolution projection system**

- Up to 2500 lumens of color brightness (color light output) and 2500 lumens of white brightness (white light output)

**Note:** Color brightness (color light output) and white brightness (white light output) will vary depending on usage conditions. Color light output measured in accordance with IDMS 15.4; white light output measured in accordance with ISO 21118.

- 1080p native resolution with 4K Enhancement
- Images up to 300 inches (7.62 m) for projection on any wall or screen

### **Full 3D projection**

- Active 3D projection with optional RF active shutter glasses
- Supports side-by-side, top-and-bottom, and frame-packing 3D formats

### **Flexible connectivity**

- Two HDMI ports for video device or computer connections
- Support for an optical HDMI connection
- One MHL-compatible HDMI port on the WirelessHD Transmitter (PowerLite Home Cinema 5040UBe)

### **Easy-to-use setup and operation features**

- Powered vertical and horizontal lens shift, and vertical keystone correction buttons for flexible projector placement

- 2.1× optical zoom ratio for improved zooming capability

[Product Box Contents](#)

[Additional Components](#)

[Optional Equipment and Replacement Parts](#)

[Warranty and Registration Information](#)

**Parent topic:** [Introduction to Your Projector](#)

## Product Box Contents

Save all the packaging in case you need to ship the projector. Always use the original packaging (or equivalent) when shipping.

Make sure your product box included all of these parts:

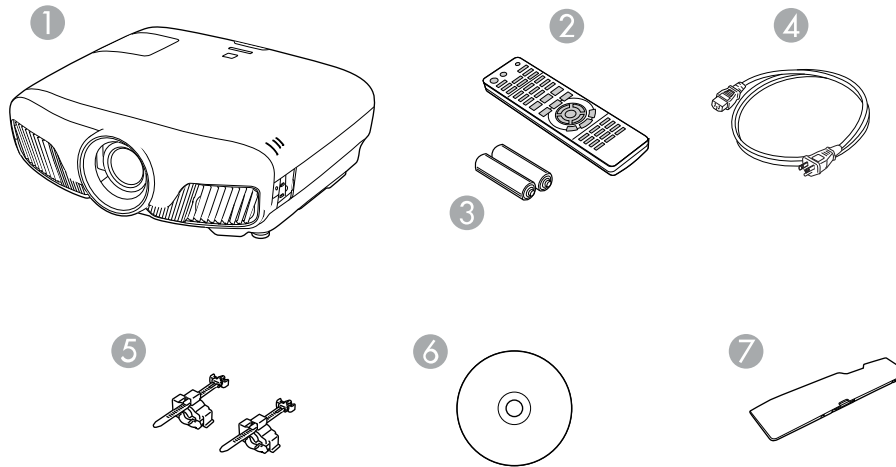

- 1 Projector
- 2 Remote control
- 3 Remote control batteries (two AA alkaline)
- 4 Power cord
- 5 HDMI cable clips (2)
- 6 Projector documentation CD

## 7 Terminal cover (PowerLite Home Cinema 5040UBe)

The PowerLite Home Cinema 5040UBe also comes with the following parts:

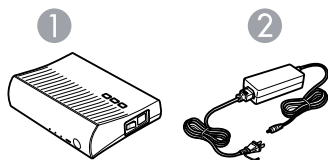

- 1 WirelessHD Transmitter
- 2 AC adapter and cord

Parent topic: [Projector Features](#)

### Additional Components

Depending on how you plan to use the projector, you may need to obtain additional components.

**Note:** To connect a Mac that does not include a compatible video output port, you need to obtain an adapter that allows you to connect to an input port on the projector. Contact Apple for compatible adapter options. To connect a smartphone or tablet, you may need to obtain an adapter that allows you to connect to the projector. This allows you to mirror your smartphone or tablet screens, watch movies, and more. Contact your device manufacturer for compatible adapter options.

Unless listed as available from Epson in this table, see your local computer or electronics dealer for purchase information.

Signal or connection type	Additional component necessary
HDMI	Compatible HDMI cable Available for purchase from Epson or an authorized Epson reseller.
Optical HDMI	Compatible optical HDMI cable

Signal or connection type	Additional component necessary
MHL (PowerLite Home Cinema 5040UBe)	<p>MHL-compatible device or a device with one of the following:</p> <ul style="list-style-type: none"> <li>• MHL cable</li> <li>• HDMI cable with a MHL adapter compatible with your device</li> <li>• integrated MHL connector</li> </ul> <p><b>Note:</b> The HDMI4 port on the WirelessHD transmitter supports MHL.</p>
3D	<p>Compatible HDMI cable and active shutter 3D glasses</p> <p>Available for purchase from Epson or an authorized Epson reseller.</p> <p><b>Note:</b> If your video source is a 3D Blu-ray disc, you also need a Blu-ray player that supports 3D playback. See your local computer or electronics dealer for purchase information.</p>
External audio	Speakers, an audio video receiver, or a video source with speaker connections, and the cables necessary for connecting them
VGA	<p>To connect a computer through its VGA port to the projector's VGA video port, you need a VGA computer cable.</p> <p>Available for purchase from Epson or an authorized Epson reseller.</p>

**Parent topic:** [Projector Features](#)

**Related references**

[Optional Equipment and Replacement Parts](#)

## Optional Equipment and Replacement Parts

You can purchase screens, other optional accessories, and replacement parts from an Epson authorized reseller. To find the nearest reseller, call 800-GO-EPSON (800-463-7766). Or you can purchase online at [epsonstore.com](http://epsonstore.com) (U.S. sales) or [epson.ca](http://epson.ca) (Canadian sales).

Epson offers the following optional accessories and replacement parts for your projector:

Option or part	Part number
Genuine Epson replacement lamp (ELPLP89)	V13H010L89

Option or part	Part number
Replacement air filter	V13H134A39
RF 3D glasses (ELPGS03)	V12H548006
Wireless LAN module (ELPAP10)	V12H731P02
Projector ceiling mount	CHF4000
Belkin PureAV HDMI audio video cable, 6 ft	AV22300-06
Belkin PureAV HDMI audio video cable, 12 ft	AV22300-12
Belkin PureAV HDMI audio video cable, 3 ft	AV22300-03
Belkin Pro Series VGA/SVGA cable, 6 ft	F3H982-06
Belkin Pro Series VGA/SVGA cable, 10 ft	F3H982-10
Belkin Pro Series VGA/SVGA cable, 25 ft	F3H982-25

In addition to the accessories listed above, 1-year and 2-year extended service plans are available.

**Parent topic:** [Projector Features](#)

## Warranty and Registration Information

Your projector comes with a basic warranty that lets you project with confidence. For details, see the warranty brochure that came with your projector.

In addition, Epson offers free Extra Care Home Service. In the unlikely event of an equipment failure, you won't have to wait for your unit to be repaired. Instead, Epson will ship you a replacement unit anywhere in the United States, Canada, or Puerto Rico. See the Extra Care Home Service brochure for details.

Register your product online using the projector CD or at this site: [epson.com/webreg](http://epson.com/webreg)

Registering also lets you receive special updates on new accessories, products, and services.

**Parent topic:** [Projector Features](#)

## Notations Used in the Documentation

Follow the guidelines in these notations as you read your documentation:

- **Warnings** must be followed carefully to avoid bodily injury.
- **Cautions** must be observed to avoid damage to your equipment.

- **Notes** contain important information about your projector.
- **Tips** contain additional projection information.

**Parent topic:** [Introduction to Your Projector](#)

## Where to Go for Additional Information

Need quick help on using your projector? Here's where to look for help:

- [epson.com/support](http://epson.com/support) (U.S) or [epson.ca/support](http://epson.ca/support) (Canada)

View FAQs (frequently asked questions) and e-mail your questions to Epson technical support 24 hours a day.

- If you still need help after checking this manual and any other sources listed here, you can use the Epson PrivateLine Support service to get help fast. For details, see "Where to Get Help".

**Parent topic:** [Introduction to Your Projector](#)

### Related references

[Where to Get Help](#)

## Additional Projector Software and Manuals

After connecting and setting up the projector, install the projector software from the included software CD, or download the software and manuals as necessary.

You can install the projector software programs listed here and view their manuals for instructions on using them.

**Note:** If you still need help after checking this manual and the sources listed here, you can use the Epson PrivateLine Support service to get help fast. For details, see "Where to Get Help".

Projector software	Manual	Description
EasyMP Multi PC Projection	<i>EasyMP Multi PC Projection Operation Guide</i>	Lets you hold interactive meetings by projecting the computer screens of users over a network.

Projector software	Manual	Description
Epson iProjection app	Instructions are included with the app	<p>Lets you project from an iOS or Android device if your projector is connected to a network that includes a wireless access point.</p> <p>Visit <a href="http://epson.com/projectorapp">epson.com/projectorapp</a> (U.S.) or <a href="http://epson.ca/projectorapp">epson.ca/projectorapp</a> (Canada) for more information.</p>

**Parent topic:** [Introduction to Your Projector](#)

**Related references**

[Where to Get Help](#)

## Projector Part Locations

Check the projector part illustrations to learn about the parts on your projector.

[Projector Parts - Front/Top](#)

[Projector Parts - Rear](#)

[Projector Parts - Base](#)

[Projector Parts - Control Panel](#)

[Projector Parts - Remote Control](#)

**Parent topic:** [Introduction to Your Projector](#)



## Projector Parts - Front/Top

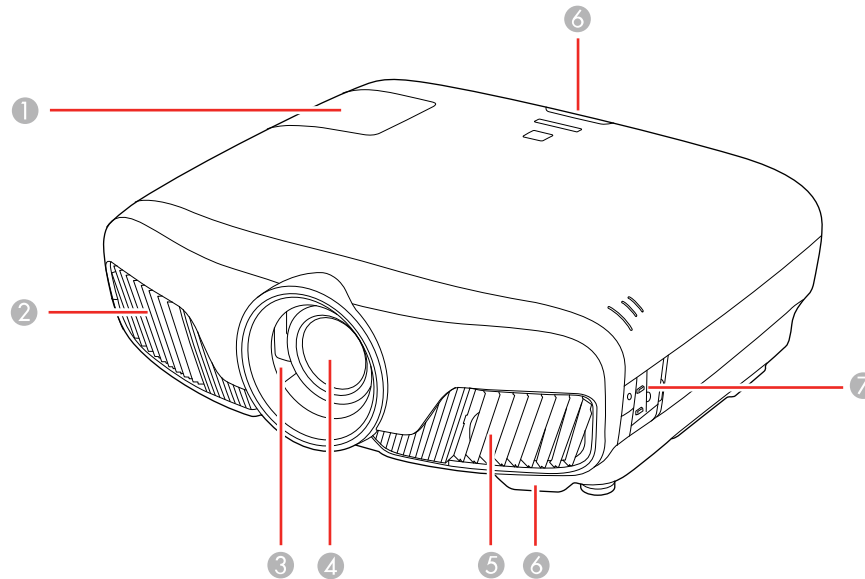

- 1 Lamp cover
- 2 Exhaust vent
- 3 Lens shutter
- 4 Lens
- 5 Air intake/air filter cover
- 6 Remote receivers
- 7 Control panel

Parent topic: [Projector Part Locations](#)

## Projector Parts - Rear

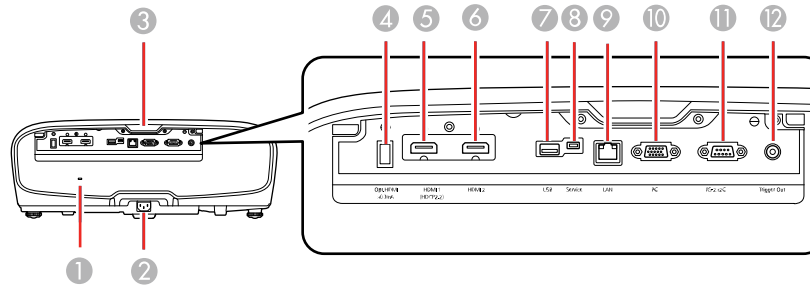

- 1 Security slot
- 2 AC input port
- 3 Remote receiver
- 4 **Opt.HDMI (300mA)** port (USB power for optical HDMI connections)
- 5 **HDMI1 (HDCP 2.2)** port
- 6 **HDMI2** port
- 7 **USB** port (for optional wireless LAN module and firmware updates)
- 8 **Service** port
- 9 **LAN** port
- 10 **PC** port (VGA)
- 11 **RS-232C** port
- 12 **Trigger Out** port

Parent topic: [Projector Part Locations](#)

### Related tasks

[Installing a Security Cable](#)

[Attaching and Removing the Cable Clips](#)

## Projector Parts - Base

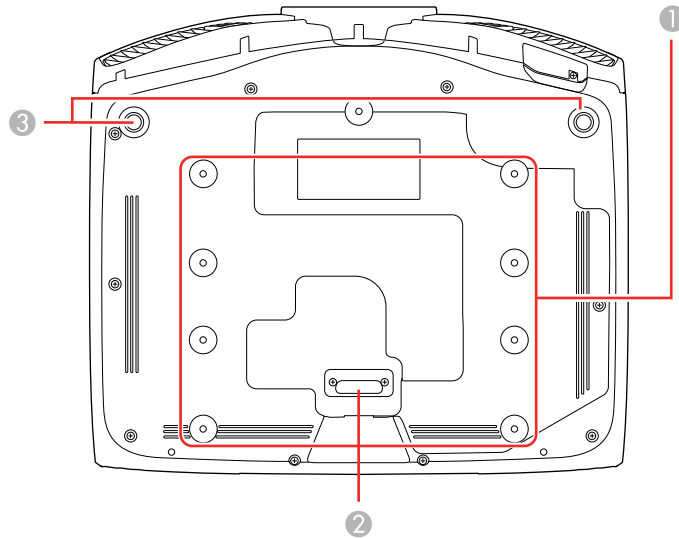

- 1 Mounting bracket holes
- 2 Rear foot
- 3 Front adjustable feet

Parent topic: [Projector Part Locations](#)

## Projector Parts - Control Panel

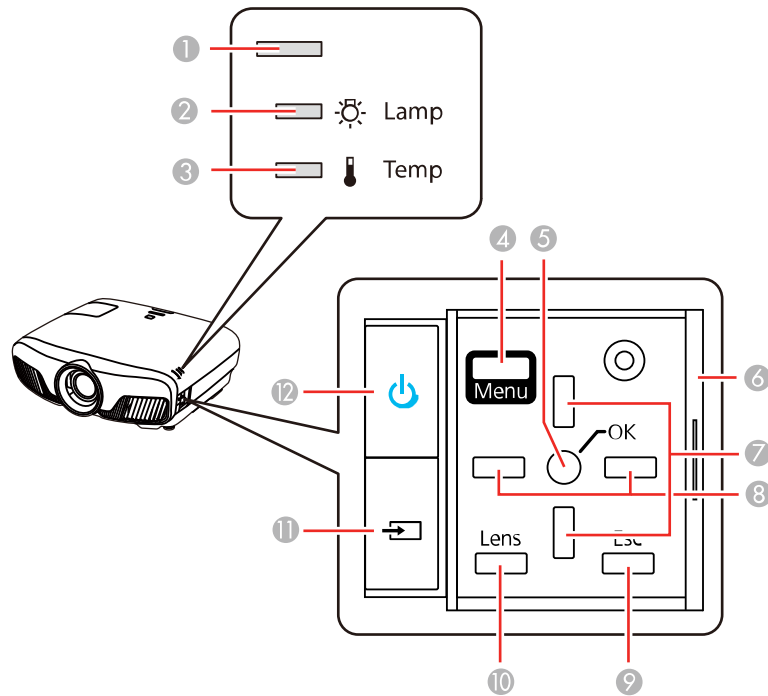

- 1 Status light
- 2 **Lamp** light
- 3 **Temp** light
- 4 **Menu** button (accesses projector menu system)
- 5 **OK** button (selects options)
- 6 Control panel cover
- 7 Vertical keystone adjustment buttons (adjust screen shape) and arrow buttons
- 8 Arrow buttons
- 9 **Esc** button (cancels/exits functions)
- 10 **Lens** button (cycles through lens adjustment options)

- 11 Source button (cycles through the list of sources)
- 12 Power button/light

Parent topic: [Projector Part Locations](#)

## Projector Parts - Remote Control

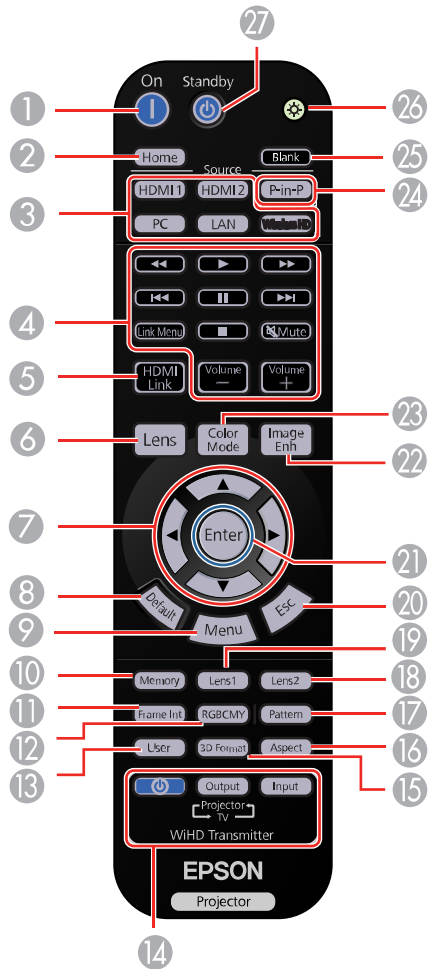

- 1 On button (turns on projector)

- 2 **Home** button (displays Home screen)
- 3 Source buttons (select specific video input sources)
- 4 **Link Menu** button (displays the main menu of the connected device)  
Control buttons (control playback and other features of connected devices that support the HDMI CEC standard)
- 5 **HDMI Link** button (displays the settings menu for HDMI Link)
- 6 **Lens** button (cycles through lens adjustment options)
- 7 Arrow buttons (move through on-screen options)
- 8 **Default** button (returns selected setting to default value)
- 9 **Menu** button (accesses projector menu system)
- 10 **Memory** button (accesses the Memory menu)
- 11 **Frame Int** button (adjusts the Frame Interpolation setting)
- 12 **RGBCMY** button (adjusts hue, saturation, and brightness for each RGBCMY color)
- 13 **User** button (customizable for different functions)
- 14 WirelessHD buttons (control the WirelessHD Transmitter; PowerLite Home Cinema 5040UBe)
- 15 **3D Format** button (changes the 3D format)
- 16 **Aspect** button (selects the image aspect ratio)
- 17 **Pattern** button (displays a test pattern)
- 18 **Lens2** button (loads the second saved lens position)
- 19 **Lens1** button (loads the first saved lens position)
- 20 **Esc** button (cancels/exits functions)
- 21 **Enter** button (selects options)
- 22 **Image Enh** button (displays the **Image Enhancement** menu)
- 23 **Color Mode** button (selects display modes)
- 24 **P-in-P** button (controls the Picture-in-Picture mode)
- 25 **Blank** button (turns off video projection)
- 26 Illumination button (lights the remote control)
- 27 **Standby** button (turns off the projector)

**Parent topic:** [Projector Part Locations](#)

**Related references**

[Remote Control Operation](#)

---

# Setting Up the Projector

Follow the instructions in these sections to set up your projector for use.

[Projector Placement](#)

[Projector Connections](#)

[Installing Batteries in the Remote Control](#)

## Projector Placement

You can place the projector on almost any flat surface to project an image.

You can also install the projector in a ceiling mount if you want to use it in a fixed location.

Keep these considerations in mind as you select a projector location:

- Place the projector on a sturdy, level surface or install it using a compatible mount.
- Leave plenty of space around and under the projector for ventilation, and do not place it on top of or next to anything that could block the vents.
- Position the projector within reach of a grounded electrical outlet or extension cord.

[Projector Setup and Installation Options](#)

[Projection Distance](#)

**Parent topic:** [Setting Up the Projector](#)

**Related tasks**

[Changing the Projection Mode Using the Menus](#)

## Projector Setup and Installation Options

You can set up or install your projector in the following ways:



Front

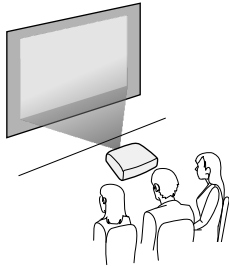

Rear

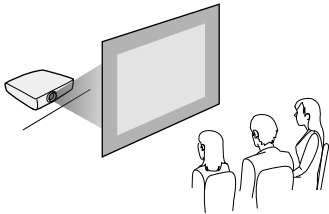

Front Ceiling

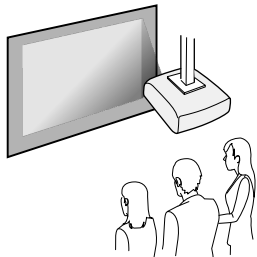

## Rear Ceiling

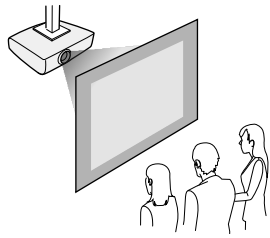

Wherever you set up the projector, make sure to position it squarely in front of the center of the screen, not at an angle, if possible.

If you project from the ceiling or from the rear, be sure to select the correct **Projection** option in the projector's menu system.

**Parent topic:** [Projector Placement](#)

### **Related references**

[Projector Setup Settings - Extended Menu](#)

## **Projection Distance**

The distance at which you place the projector from the screen determines the approximate size of the image. The image size increases the farther the projector is from the screen, but can vary depending on the zoom factor, aspect ratio, and other settings.

Use the tables here to determine approximately how far to place the projector from the screen based on the size of the projected image. (Conversion figures may have been rounded up or down.)

You can also use the projector Throw Distance Calculator at [epson.com/support](http://epson.com/support) (U.S.) or [epson.ca/support](http://epson.ca/support) (Canada).

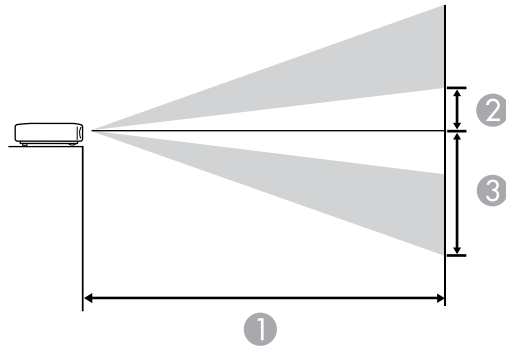

#### 4:3 Aspect Ratio Image or Screen

Screen or image size	Projection distance (1) Wide to Tele	Offset from lens center (2)	Offset from lens center (3)
50 inches (127 cm)	72 to 151 inches (182 to 384 cm)	13.9 inches (35 cm)	43.9 inches (111 cm)
60 inches (152.4 cm)	86 to 182 inches (219 to 462 cm)	16.7 inches (42 cm)	52.7 inches (134 cm)
80 inches (203.2 cm)	115 to 243 inches (293 to 617 cm)	22.2 inches (56 cm)	70.2 inches (178 cm)
100 inches (254 cm)	145 to 304 inches (368 to 772 cm)	27.8 inches (71 cm)	87.8 inches (223 cm)
120 inches (304.8 cm)	174 to 365 inches (442 to 927 cm)	33.3 inches (854 cm)	105.3 inches (268 cm)
150 inches (381 cm)	218 to 457 inches (554 to 1160 cm)	41.7 inches (106 cm)	131.7 inches (334 cm)

<b>Screen or image size</b>	<b>Projection distance (1) Wide to Tele</b>	<b>Offset from lens center (2)</b>	<b>Offset from lens center (3)</b>
200 inches (508 cm)	291 to 610 inches (740 to 1548 cm)	55.6 inches (141 cm)	175.6 inches (446 cm)
220 inches (558.8 cm)	321 to 671 inches (814 to 1704 cm)	61.1 inches (155 cm)	193.1 inches (491 cm)
244.8 inches (622 cm)	357 to 746 inches (906 to 1896 cm)	68 inches (173 cm)	214.8 inches (546 cm)

### **16:9 Aspect Ratio Image or Screen**

<b>Screen or image size</b>	<b>Projection distance (1) Wide to Tele</b>	<b>Offset from lens center (2)</b>	<b>Offset from lens center (3)</b>
50 inches (127 cm)	58 to 123 inches (148 to 313 cm)	11.3 inches (29 cm)	35.9 inches (91 cm)
60 inches (152.4 cm)	70 to 148 inches (178 to 376 cm)	13.6 inches (35 cm)	43 inches (109 cm)
80 inches (203.2 cm)	94 to 198 inches (239 to 630 cm)	18.2 inches (46 cm)	57.4 inches (146 cm)
100 inches (254 cm)	118 to 248 inches (300 to 630 cm)	22.7 inches (58 cm)	71.7 inches (182 cm)
150 inches (381 cm)	178 to 373 inches (452 to 947 cm)	34 inches (86 cm)	107.6 inches (273 cm)
200 inches (508 cm)	238 to 498 inches (604 to 1264 cm)	45.4 inches (115 cm)	143.4 inches (364 cm)
250 inches (635 cm)	297 to 623 inches (756 to 1582 cm)	56.7 inches (144 cm)	179.3 inches (455 cm)

Screen or image size	Projection distance (1) Wide to Tele	Offset from lens center (2)	Offset from lens center (3)
300 inches (762 cm)	357 to 748 inches (908 to 1899 cm)	68.1 inches (173 cm)	215.2 inches (547 cm)

Parent topic: [Projector Placement](#)

## Projector Connections

See these sections to connect the projector to a variety of projection sources.

**Caution:** If you will use the projector at altitudes above 4921 feet (1500 m), turn on **High Altitude Mode** to ensure the projector's internal temperature is regulated properly.

[Removing and Attaching the Terminal Cover](#)

[Connecting to an HDMI Video Source](#)

[Connecting to Computer Sources](#)

[Attaching and Removing the Cable Clips](#)

[Connecting to External Speakers](#)

[Connecting to a Trigger Out Port](#)

Parent topic: [Setting Up the Projector](#)

### Related references

[Projector Setup Settings - Extended Menu](#)

## Removing and Attaching the Terminal Cover

Before you can connect equipment to your projector, you need to remove the terminal cover. (PowerLite Home Cinema 5040UBe)

Using the gaps at the bottom of the terminal cover, pull the cover out and remove it.

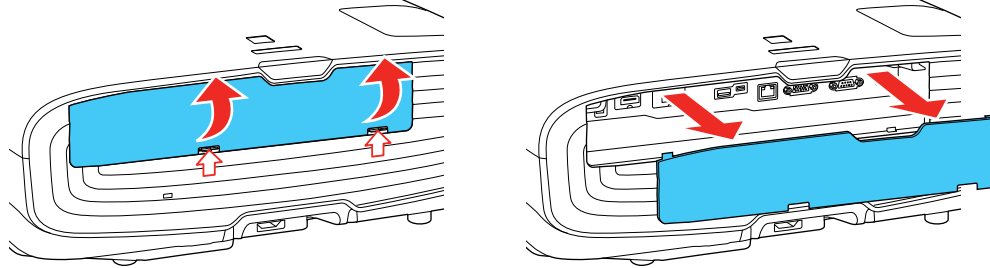

To reattach the cover, reverse the steps to remove it.

Parent topic: [Projector Connections](#)

## Connecting to an HDMI Video Source

If your video source has an HDMI port, you can connect it to the projector using an optional HDMI cable. The HDMI connection provides the best image quality.

1. Connect the HDMI cable to your video source's HDMI output port.
2. Connect the other end to one of the projector's HDMI ports. If you are connecting an optical HDMI cable, you must also connect the cable's USB power connector to the **Opt.HDMI (300mA)** port.

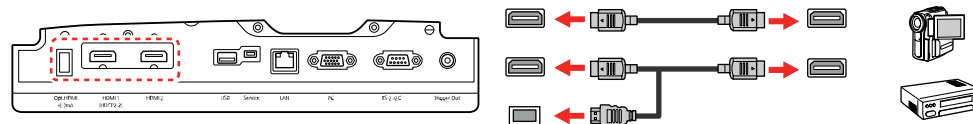

**Note:** When an audio/video source that meets the HDMI CEC standard is connected to the projector's HDMI port, you can use the projector's remote control to control certain features of the linked device by pressing the **HDMI Link** button on the remote control and setting **HDMI Link** to **On**.

Parent topic: [Projector Connections](#)

### Related references

[Projector Feature Settings - Settings Menu](#)

## Related tasks

[Attaching and Removing the Cable Clips](#)

## Connecting to Computer Sources

Follow the instructions in these sections to connect a computer to the projector.

[Connecting to a Computer for VGA Video](#)

[Connecting to a Computer for HDMI Video](#)

**Parent topic:** [Projector Connections](#)

### Connecting to a Computer for VGA Video

You can connect the projector to your computer using a VGA computer cable.

**Note:** To connect a Mac that includes only a Mini DisplayPort, Thunderbolt port, or Mini-DVI port for video output, you need to obtain an adapter that allows you to connect to the projector's VGA video port. Contact Apple for compatible adapter options.

1. If necessary, disconnect your computer's monitor cable.
2. Connect the VGA computer cable to your computer's monitor port.
3. Connect the other end to a **PC** port on the projector.

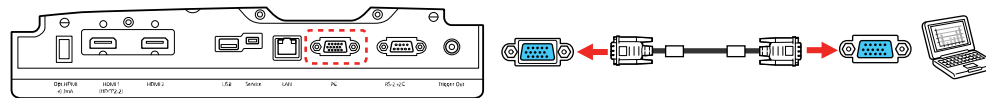

4. Tighten the screws on the VGA connector.

**Parent topic:** [Connecting to Computer Sources](#)

### Connecting to a Computer for HDMI Video

If your computer has an HDMI port, you can connect it to the projector using an optional HDMI cable.

**Note:** To connect a Mac that includes only a Mini DisplayPort, Thunderbolt port, or Mini-DVI port for video output, you need to obtain an adapter that allows you to connect to the projector's **HDMI** port. Contact Apple for compatible adapter options.

1. Connect the HDMI cable to your computer's HDMI output port.

2. Connect the other end to one of the projector's HDMI ports. If you are connecting an optical HDMI cable, you must also connect the cable's USB power connector to the **Opt.HDMI (300mA)** port.

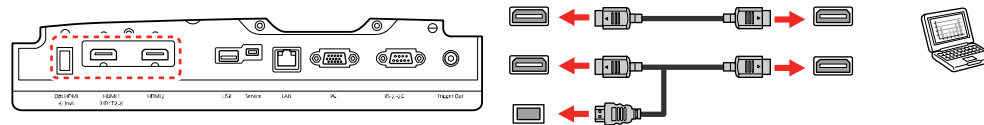

**Parent topic:** [Connecting to Computer Sources](#)

**Related tasks**

[Attaching and Removing the Cable Clips](#)

## Attaching and Removing the Cable Clips

You can install the cable clips that came with your projector to provide additional support to the HDMI cables.

1. Plug in the HDMI cables.
2. Insert each guide into the cable clip holes near the **HDMI** port.
3. Attach the cable clips to the HDMI cables. Be sure to leave the clamps unlocked.
4. Slide each cable clip onto the guides and lock the clamps onto the connectors.

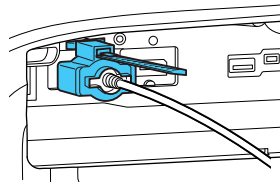

To remove the cable clips, open the clamps and disconnect the cables. Then pinch the sides of each guide and carefully pull them out of the cable clip holes.

**Parent topic:** [Projector Connections](#)

## Connecting to External Speakers

To add sound, you can connect your video source and speakers to an audio video receiver, then connect the receiver to the projector using one of the receiver's compatible video outputs (an HDMI



connection provides the best image quality, if available). You can also connect speakers to any video source that has its own speaker connections.

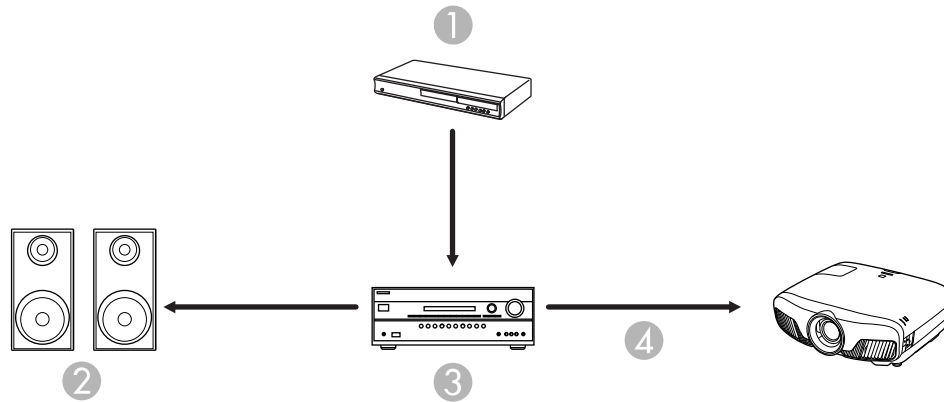

- 1 Video source
- 2 Surround sound speakers
- 3 Receiver
- 4 Video cable

Parent topic: [Projector Connections](#)

## Connecting to a Trigger Out Port

You can connect your projector to external devices such as motorized screens that support a trigger signal. When active, a 12V signal is sent to the connected device while the projector is powered on.

1. Connect a 3.5 mm stereo mini-jack cable to the external device's trigger port. See your device's documentation for details.
2. Connect the other end to the projector's **Trigger Out** port.

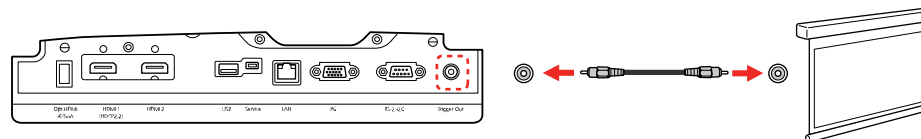

3. Turn on the **Trigger Out** setting in the projector's **Extended** menu.

**Parent topic:** [Projector Connections](#)

**Related references**

[Projector Setup Settings - Extended Menu](#)

## Installing Batteries in the Remote Control

The remote control uses the two AA batteries that came with the projector.

**Caution:** Use only the type of batteries specified in this manual. Do not install batteries of different types, or mix new and old batteries.

1. Remove the battery cover.

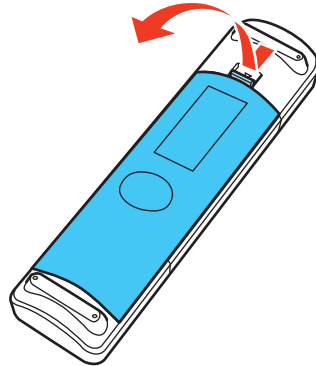

2. Insert the batteries with the + and – ends facing as shown.

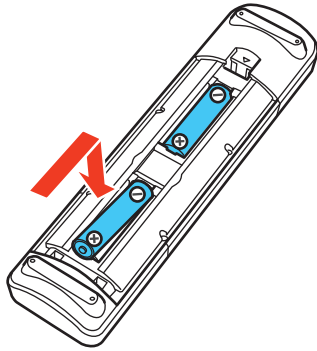

3. Replace the battery cover and press it down until it clicks into place.

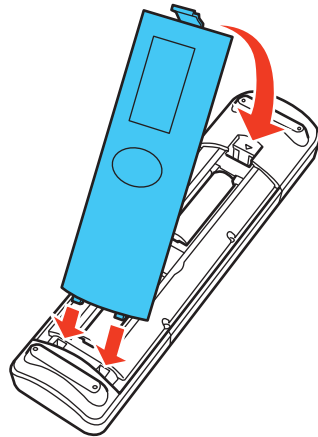

**Warning:** Dispose of used batteries according to local regulations. Do not expose batteries to heat or flame. Keep batteries out of the reach of children; they are choking hazards and are very dangerous if swallowed.

**Parent topic:** [Setting Up the Projector](#)

**Related references**

[Remote Control Specifications](#)

---

# Using the Projector on a Network

Follow the instructions in these sections to set up your projector for use on a network.

[Wired Network Projection](#)

[Wireless Network Projection](#)

[Selecting External Network Detection Settings](#)

## Wired Network Projection

You can project through a wired network. To do this, you connect the projector to your network, and then set up your projector and computer for network projection.

After connecting and setting up the projector as described here, install the network software from the included CD or download the software and manuals as necessary.

**Note:** If your projector is connected via a LAN cable to a network that includes a wireless access point, you can connect to the projector wirelessly through the access point using the Epson network software.

[Connecting to a Wired Network](#)

[Selecting Wired Network Settings](#)

**Parent topic:** [Using the Projector on a Network](#)

**Related references**

[Additional Projector Software and Manuals](#)

## Connecting to a Wired Network

To connect the projector to a wired local area network (LAN), use a 100Base-TX or 10Base-T network cable. To ensure proper data transmission, use a Category 5 shielded cable or better.

1. Connect one end of the network cable to your network hub, switch, or router.
2. Connect the other end of the cable to the projector's **LAN** port.

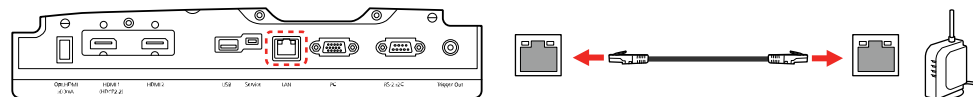

**Parent topic:** [Wired Network Projection](#)

## Selecting Wired Network Settings

Before you can project from computers, tablets, or smartphones over your network, you must select the network settings for the projector using its menu system.

**Note:** Make sure you already connected the projector to your wired network using the **LAN** port.

1. Turn on the projector.
2. Press the **Menu** button.
3. Select the **Network** menu and press **Enter**.

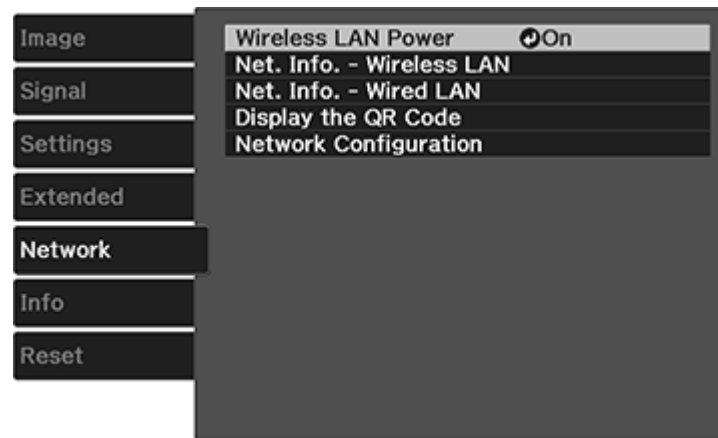

4. Select **Network Configuration** and press **Enter**.

5. Select the **Basic** menu and press **Enter**.

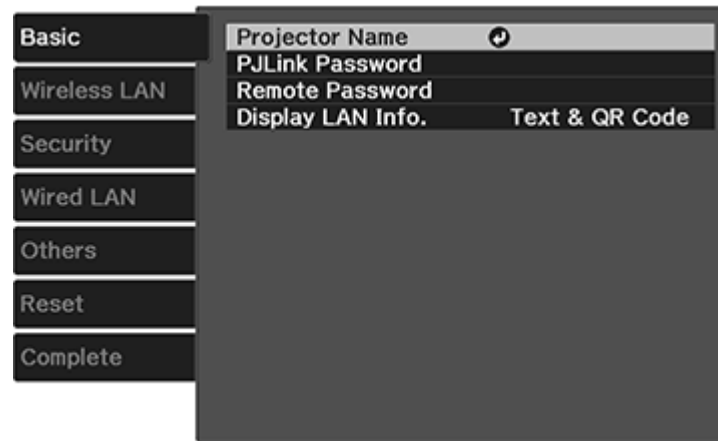

6. Select the following basic options as necessary:

- **Projector Name** lets you enter a name up to 16 alphanumeric characters long to identify the projector over the network.
- **PJLink Password** lets you enter a password up to 32 alphanumeric characters long for using the PJLink protocol for projector control.
- **Remote Password** lets you enter a password up to 8 alphanumeric characters long for accessing the Remote or Basic Control screen on a smartphone or tablet.

**Note:** Use the displayed keyboard to enter the name, passwords and keyword. Press the arrow buttons on the remote control to highlight characters and press **Enter** to select them. Press **Finish** when you are done.

7. Select the **Wired LAN** menu and press **Enter**.

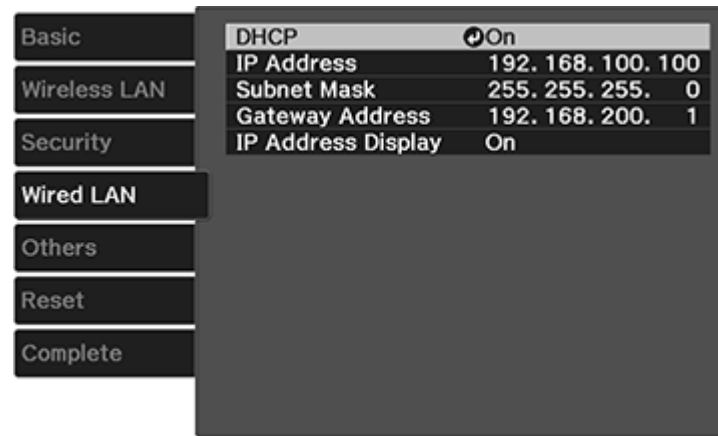

8. Select your IP Settings as necessary:
  - If your network assigns addresses automatically, turn on the **DHCP** setting.
  - If you must set addresses manually, turn off **DHCP** and enter the projector's **IP Address**, **Subnet Mask**, and **Gateway Address** as needed.

**Note:** To highlight the numbers you want from the displayed keyboard, press the arrow buttons on the remote control. To select a highlighted number, press **Enter**. Press **Finish** when you are done.

9. To prevent display of the IP address on the standby screen, turn off **IP Address Display**.
10. When you finish selecting settings, select **Complete** and follow the on-screen instructions to save your settings and exit the menus.

**Parent topic:** [Wired Network Projection](#)

## Wireless Network Projection

You can project over a wireless network. To do this, you must set up your projector and computer for wireless projection.

**Note:** The Epson 802.11b/g/n wireless LAN module is not included with your projector and is optional.

To connect wirelessly to your projector, configure the connection using the projector's Network menus.

After setting up the projector as described here, install the network software from the included CD or download the software and manuals as necessary.

**Note:** If your projector is connected via a LAN cable to a network that includes a wireless access point, you can connect to the projector wirelessly through the access point using the Epson network software.

[Installing the Wireless LAN Module](#)

[Selecting Wireless Network Settings Manually](#)

[Using a QR Code to Connect a Mobile Device](#)

[Searching for a Wireless Network](#)

[Selecting Wireless Network Settings in Windows](#)

[Selecting Wireless Network Settings in OS X](#)

[Enabling WPA or WPA2 Security](#)

**Parent topic:** [Using the Projector on a Network](#)

**Related references**

[Additional Projector Software and Manuals](#)

## Installing the Wireless LAN Module

To use the projector over a wireless network, install the Epson 802.11b/g/n wireless LAN module in the projector. Do not install any other type of wireless module.

Insert the wireless LAN module into the **USB** port.

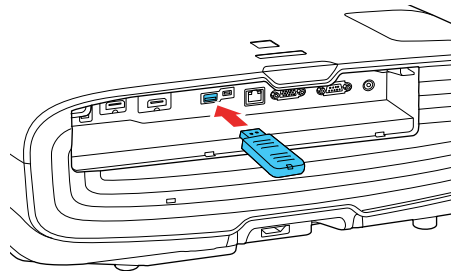

The light on the wireless LAN module turns on when the module is installed and operating. The light flashes when the module is communicating over the network.

**Parent topic:** [Wireless Network Projection](#)



## Selecting Wireless Network Settings Manually

Before you can project from your wireless network, you must select the network settings for the projector using its menu system.

1. Turn on the projector.
2. Press the **Menu** button.
3. Select the **Network** menu and press **Enter**.

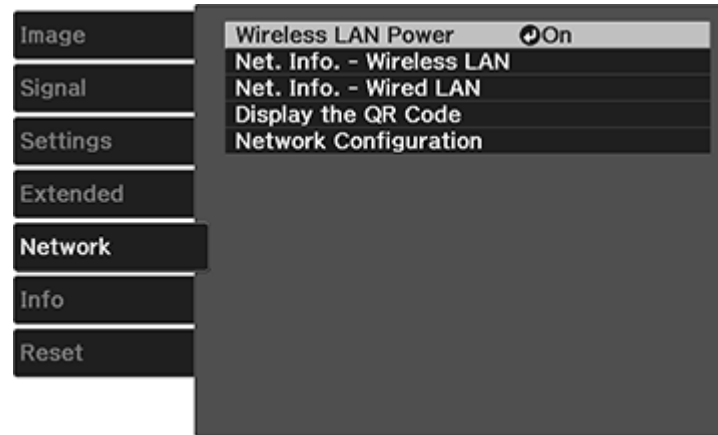

4. Make sure the **Wireless LAN Power** setting is set to **On**.
5. Select **Network Configuration** and press **Enter**.

6. Select the **Basic** menu and press **Enter**.

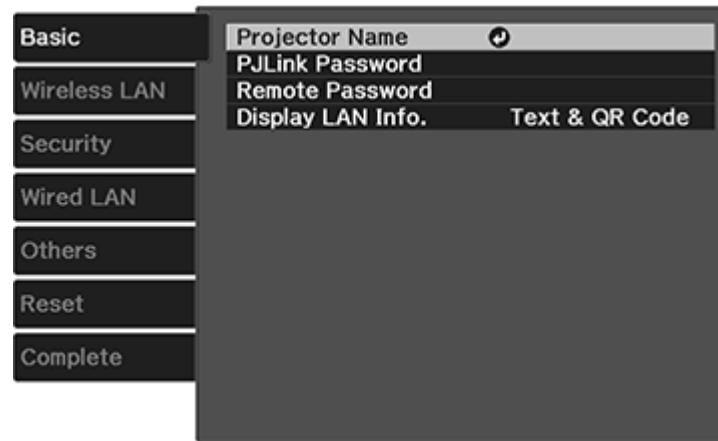

7. Select the following basic options as necessary:

- **Projector Name** lets you enter a name up to 16 alphanumeric characters long to identify the projector over the network.
- **PJLink Password** lets you enter a password up to 32 alphanumeric characters long for using the PJLink protocol for projector control.
- **Remote Password** lets you enter a password up to 8 alphanumeric characters long for accessing the Remote or Basic Control screen on a smartphone or tablet.
- **Display LAN Info** lets you select how the projector displays network information. You can select an option to display a QR code that lets you quickly connect your iOS or Android devices using the Epson iProjection app.

**Note:** Use the displayed keyboard to enter the name, passwords and keyword. Press the arrow buttons on the remote control to highlight characters and press **Enter** to select them. Press **Finish** when you are done.

8. Select the **Wireless LAN** menu and press **Enter**.

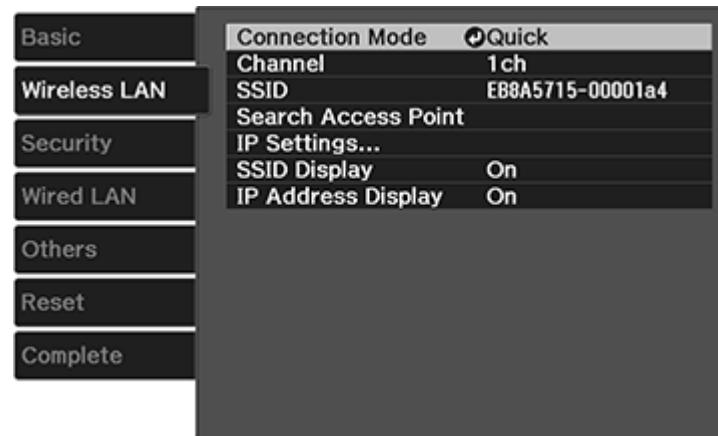

9. Select the settings on the **Wireless LAN** menu as necessary for your network.
10. When you finish selecting settings, select **Complete** and follow the on-screen instructions to save your settings and exit the menu.

**Note:** Check your network security settings after completing the wireless settings.

After you complete the wireless settings for your projector, you need to select the wireless network on your computer, or iOS or Android device.

[Wireless LAN Menu Settings](#)

[Restricted IP Addresses](#)

**Parent topic:** [Wireless Network Projection](#)

## Wireless LAN Menu Settings

Setting	Options	Description
<b>Connection Mode</b>	<b>Quick</b> <b>Advanced</b>	Selects the type of wireless connection: <b>Quick:</b> lets you quickly connect to one computer <b>Advanced:</b> lets you connect to multiple computers via a wireless network access point (infrastructure mode)
<b>Channel</b>	<b>1ch</b> <b>6ch</b> <b>11ch</b>	In <b>Quick</b> connection mode, selects the frequency band (channel) used by the wireless LAN
<b>SSID</b>	Up 32 alphanumeric characters	Sets the SSID (network name) of the wireless LAN system the projector is connecting to
<b>Search Access Point</b>	<b>To Search View</b>	Searches for available wireless network access points in <b>Advanced</b> connection mode
<b>IP Settings</b>	—	Turns on DHCP if your network assigns addresses automatically; set to <b>Off</b> to manually enter the network's <b>IP Address</b> , <b>Subnet Mask</b> , and <b>Gateway Address</b> (see list of restricted IP addresses in link below)
<b>SSID Display</b>	<b>On</b> <b>Off</b>	Selects whether to display the SSID on the network standby screen and the Home screen
<b>IP Address Display</b>	<b>On</b> <b>Off</b>	Selects whether to display the IP address on the network standby screen and the Home screen

Parent topic: [Selecting Wireless Network Settings Manually](#)

## Related references

[Restricted IP Addresses](#)

### Restricted IP Addresses

When manually entering IP Settings, you cannot use these ranges of IP addresses:

Setting	Restricted IP addresses
IP Address	0.0.0.0 127.x.x.x 224.0.0.0 to 255.255.255.255
Subnet Mask	0.0.0.0 255.255.255.255
Gateway Address	0.0.0.0 197.x.x.x 224.0.0.0 to 255.255.255.255

Parent topic: [Selecting Wireless Network Settings Manually](#)

### Using a QR Code to Connect a Mobile Device

After you select the wireless network settings for your projector, you can display a QR code on the screen and use it to connect a mobile device using the Epson iProjection app.

**Note:** Make sure you have installed the latest version of Epson iProjection on your device. Visit [epson.com/projectorapp](http://epson.com/projectorapp) (U.S.) or [epson.ca/projectorapp](http://epson.ca/projectorapp) (Canada) for more information.

1. Press the **Menu** button.

2. Select the **Network** menu and press **Enter**.

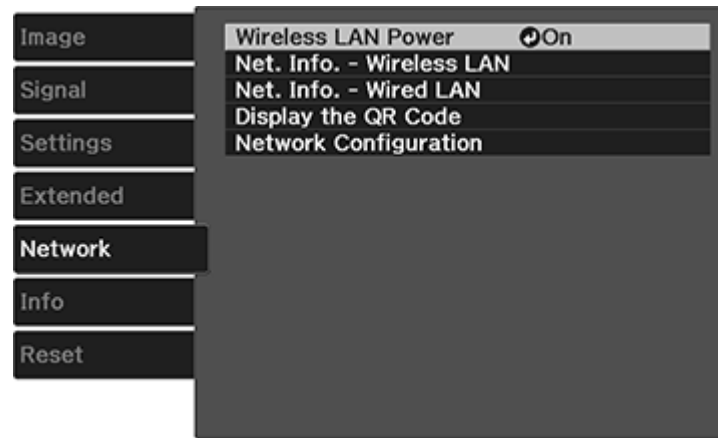

3. Select **Network Configuration** and press **Enter**.
4. Select the **Basic** menu and press **Enter**.

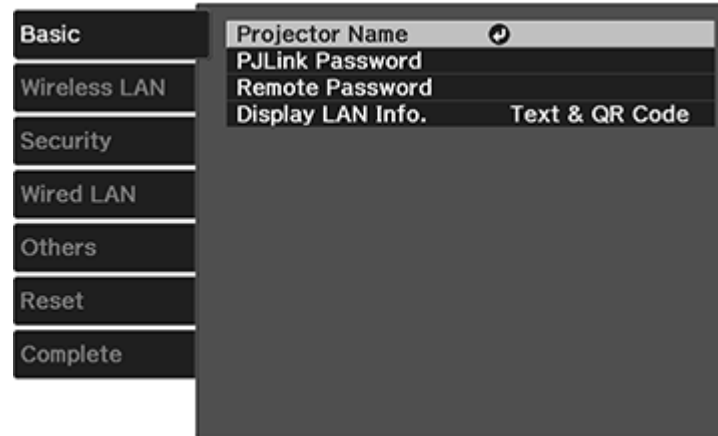

5. Set the **Display LAN Info** setting to **Text & QR Code**.
6. Select **Complete** and follow the on-screen instructions to save your settings and exit the menus.

7. Press the **LAN** button on the remote control or select **Display the QR Code** in the projector's Network menu. (You can also press the **Home** button on the remote control and select **Display the QR Code** on the Home screen.)

Your projector displays the QR code on the projection surface.

**Note:** If you do not see the QR code after pressing the **LAN** button, press **Enter** to display it.

8. Start Epson iProjection on your mobile device.
9. Use the QR code reader feature to read the QR code and connect your device to the projector. Visit [epson.com/projectorapp](http://epson.com/projectorapp) (U.S.) or [epson.ca/projectorapp](http://epson.ca/projectorapp) (Canada) for instructions.

**Parent topic:** [Wireless Network Projection](#)

## Searching for a Wireless Network

You can use your projector's site survey function to quickly locate and connect to available wireless networks.

1. Turn on the projector.
2. Press the **Menu** button.
3. Select the **Network** menu and press **Enter**.

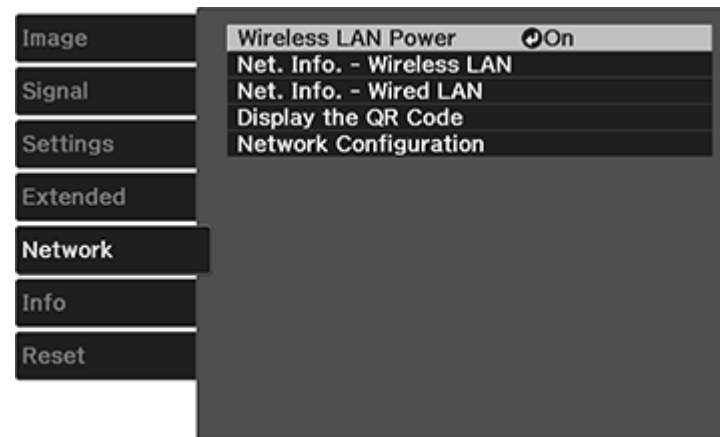

4. Select **Network Configuration** and press **Enter**.

5. Select the **Wireless LAN** menu and press **Enter**.

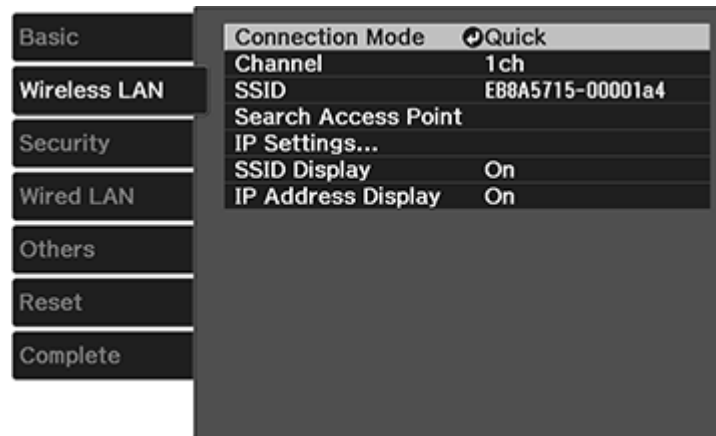

6. Select **Advanced** as the Connection Mode setting and press **Enter**.
7. Select **Search Access Point** and press **Enter**.
8. Select the name of the wireless network you want to connect to and press **Enter**.
9. If the network has security enabled, enter the wireless password.

You see a screen like this:





10. Select the settings on the Security menu as necessary for your network.
11. When you finish selecting settings, select **Complete** and follow the on-screen instructions to save your settings and exit the menus.

**Parent topic:** [Wireless Network Projection](#)

## Selecting Wireless Network Settings in Windows

Before connecting to the projector, select the correct wireless network on your computer.

1. To access your wireless utility software, access the Desktop and double-click the network icon on the Windows taskbar.
2. Do one of the following:
  - If your projector is set up on an existing network (Advanced mode), select the network name (SSID).
  - If your projector is configured for Quick mode, select the projector's SSID.
3. Click **Connect**.

**Parent topic:** [Wireless Network Projection](#)

## Selecting Wireless Network Settings in OS X

Before connecting to the projector, select the correct wireless network in OS X.

1. Click the AirPort icon on the menu bar at the top of the screen.
2. Make sure AirPort is turned on, then do one of the following:
  - If your projector is set up on an existing network (Advanced mode), select the network name (SSID).
  - If your projector is configured for Quick mode, select the projector's SSID.

**Parent topic:** [Wireless Network Projection](#)

## Enabling WPA or WPA2 Security

Set up the WPA or WPA2 security settings to match your network's settings. Check with your network administrator for guidance on entering the correct information.

1. Turn on the projector.
2. Press the **Menu** button.

3. Select the **Network** menu and press **Enter**.

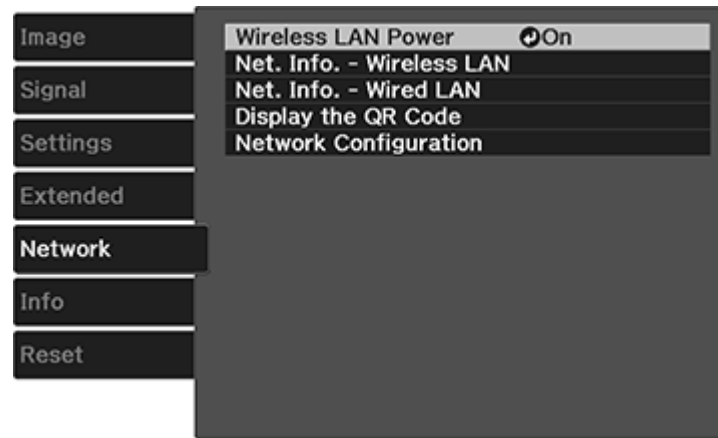

4. Select **Network Configuration** and press **Enter**.
5. Select the **Security** menu and press **Enter**.
6. Select the settings on the Security menu as necessary for your network.
7. When you finish selecting settings, select **Complete** and follow the on-screen instructions to save your settings and exit the menus.

[Wireless Security Menu Settings](#)

Parent topic: [Wireless Network Projection](#)

**Wireless Security Menu Settings**

Settings on the Security menu let you select the type of security and security settings that match the network you are connecting the projector to.

Setting	Options	Description
Security	No WPA2-PSK WPA/WPA2-PSK	Selects the type of security used on the wireless network

Setting	Options	Description
Passphrase	—	For the selected security, selects the pre-shared passphrase used on the network

Parent topic: [Enabling WPA or WPA2 Security](#)

## Selecting External Network Detection Settings

If you are using a compatible network control system, you can select settings that allow your projector to be detected by those systems.

1. Press the **Menu** button.
2. Select the **Network** menu and press **Enter**.
3. Select **Network Configuration** and press **Enter**.
4. Select the **Others** menu and press **Enter**.

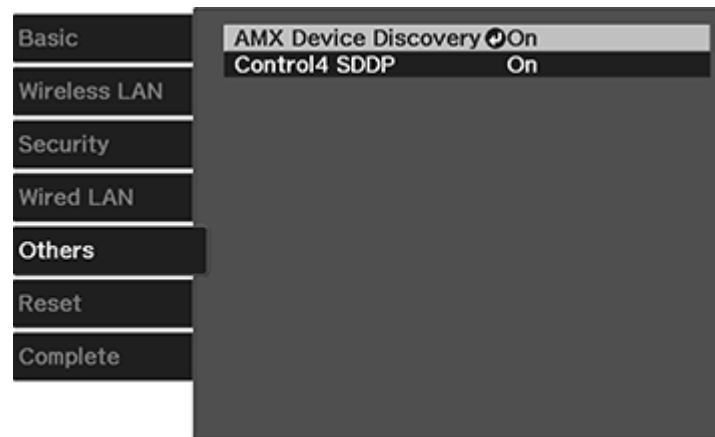

5. If your network environment uses an AMX controller, turn on the **AMX Device Discovery** setting to allow the projector to be detected.
6. If your network environment uses a Control4 or Control4 SDDP controller, turn on the **Control4 SDDP** setting to allow the projector to be detected.
7. When you finish selecting settings, select **Complete** and follow the on-screen instructions to save your settings and exit the menus.

**Parent topic:** [Using the Projector on a Network](#)

---

# Using Basic Projector Features

Follow the instructions in these sections to use your projector's basic features.

[Turning On the Projector](#)

[Turning Off the Projector](#)

[Viewing 3D Images](#)

[Selecting the Language for the Projector Menus](#)

[Adjusting the Image Height](#)

[Adjusting the Image Position Using Lens Shift](#)

[Image Shape](#)

[Resizing the Image with the Zoom Feature](#)

[Focusing the Image with the Lens Button](#)

[Remote Control Operation](#)

[Selecting an Image Source](#)

[Projection Modes](#)

[Image Aspect Ratio](#)

[Color Mode](#)

## Turning On the Projector

Turn on the computer or video equipment you want to use before you turn on the projector so it can display the image source.

1. Connect the power cord to the projector's power inlet.

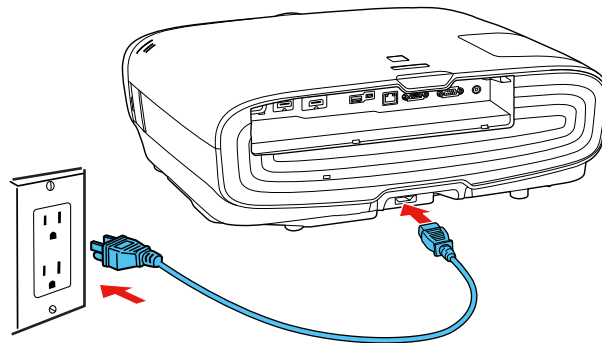

2. Plug the power cord into an electrical outlet.

**Note:** With **Direct Power On** turned on, the projector turns on as soon as you plug it in.

The projector's power light turns blue. This indicates that the projector is receiving power.

3. Press the power button on the projector or the **On** button on the remote control to turn on the projector.

The shutter opens and the status light flashes blue as the projector warms up. Once the projector is warmed up, the status light stops flashing and turns blue.

**Warning:** Never look into the projector lens when the lamp is on. This can damage your eyes and is especially dangerous for children.

If you do not see a projected image right away, try the following:

- Turn on the connected computer or video device.
- Insert a DVD or other video media and press the play button, if necessary.
- Press the source button on the projector to detect the video source, or press a source button on the remote control.
- If the Home screen is displayed, select the source you want to project.

[Using the Home Screen](#)

**Parent topic:** [Using Basic Projector Features](#)

**Related references**

[Projector Setup Settings - Extended Menu](#)

## Using the Home Screen

You can select input sources and other frequently used options from the Home screen.

1. To display the Home screen, do one of the following:
  - Press the **Home** button on the remote control.
  - Turn on the projector with the **Home Screen Auto Disp** setting enabled.
  - Turn on the projector when no signal is received from the selected input source.

2. Press the arrow buttons on the remote control or control panel to navigate the screen, and press **Enter** to select an option.

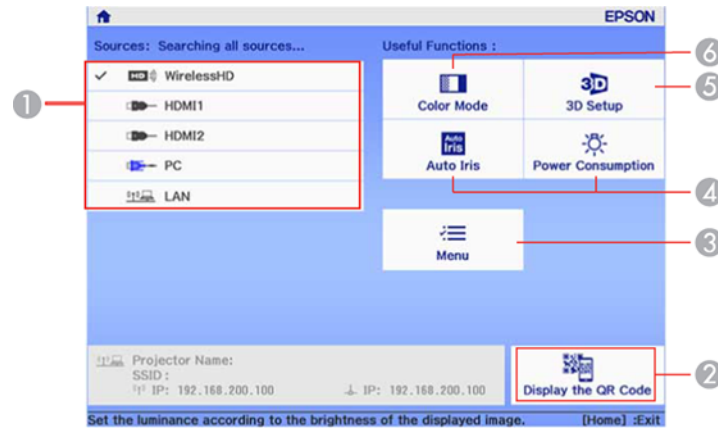

- 1 Select the video source you want to project
- 2 Display the QR code
- 3 Display the projector's menus
- 4 Select customizable menu options
- 5 Select to change the 3D settings
- 6 Select to change the Color Mode

**Note:** You can select the customizable menu options using the **Custom Function 1** and **Custom Function 2** settings in the Extended menu.

3. Press the **Home** button to hide the Home screen.

**Parent topic:** [Turning On the Projector](#)

**Related references**

[Projector Setup Settings - Extended Menu](#)

## Turning Off the Projector

Before turning off the projector, shut down any computer connected to it so you can see the computer display during shutdown.

**Note:** Turn off this product when not in use to prolong the life of the projector. Lamp life will vary depending upon mode selected, environmental conditions, and usage. Brightness decreases over time.

**Note:** When using the Blank feature, the projector lamp is still on. To turn off the lamp, turn off the projector.

1. Press the power button on the projector or the **Standby** button on the remote control.  
The projector displays a shutdown confirmation screen.

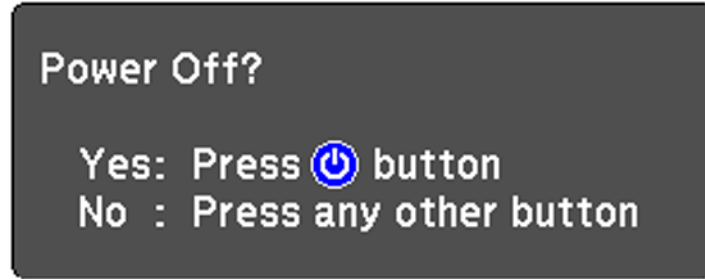

2. Press the power button on the projector or the **Standby** button on the remote control again. (To leave it on, press any other button.)  
The lamp turns off and the lens shutter closes. The projector's status light flashes and then turns off.



3. To transport or store the projector, make sure the status light is off, then unplug the power cord.

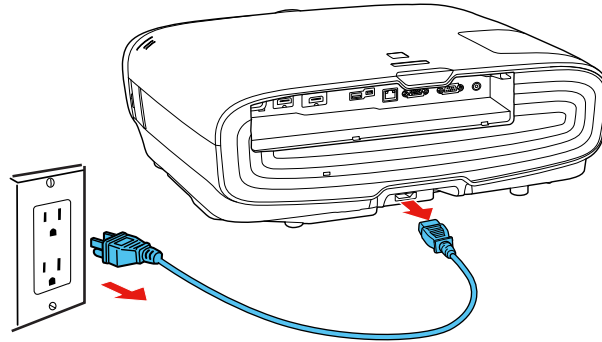

**Caution:** To avoid damaging the projector or lamp, never unplug the power cord when the status light is on or flashing.

**Parent topic:** [Using Basic Projector Features](#)

**Related tasks**

[Shutting Off the Picture Temporarily](#)

[Transporting the Projector](#)

## Viewing 3D Images

You can view 3D images using your projector. Viewing 3D images requires a 3D-compatible video device, a compatible HDMI cable, and a pair of Epson RF 3D glasses (not included with your projector). You can also convert 2D images to 3D using the **2D-to-3D Conversion** setting in your projector's **Signal > 3D Setup** menu.

You can purchase Epson RF 3D glasses from an Epson authorized reseller. To find the nearest reseller, call 800-GO-EPSON (800-463-7766). Or you can purchase online at [epsonstore.com](http://epsonstore.com) (U.S. sales) or [epson.ca](http://epson.ca) (Canadian sales).

**Note:** Make sure the **3D Display** setting on the **Signal** menu is set to **Auto** or **3D**.

1. Connect a 3D-compatible video device to the projector using a compatible HDMI cable.
2. Turn on the video device, then turn on the projector.

3. Begin playback from the video device.

**Note:** Make sure you set the video device to play content in 3D mode.

4. Slide the power switch on the 3D glasses to the **On** position.

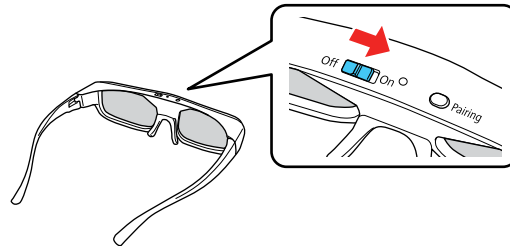

5. Put on the 3D glasses. If you do not see a 3D image, pair the glasses with the projector.

**Note:** If you change the video source or you are not within range of your projector, the glasses enter standby mode and the status light flashes green. Slide the power switch on the glasses to the **Off** position and then back to the **On** position to resume 3D viewing.

[Pairing the 3D Glasses with the Projector](#)

[Charging the 3D Glasses](#)

[3D Viewing Range](#)

**Parent topic:** [Using Basic Projector Features](#)

**Related references**

[Input Signal Settings - Signal Menu](#)

## Pairing the 3D Glasses with the Projector

Pair the glasses with the projector to establish communication between them for 3D viewing.

1. Turn on the projector.
2. Set the image source to HDMI or WirelessHD (PowerLite Home Cinema 5040UBe) on the projector.
3. Project a 3D image.

- Slide the power switch on the 3D glasses to the **On** position.

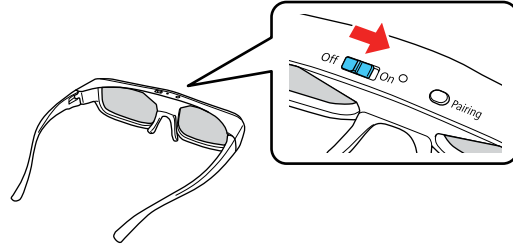

- Move the glasses within 10 feet (3 m) of the projector and hold down the **Pairing** button for at least three seconds.

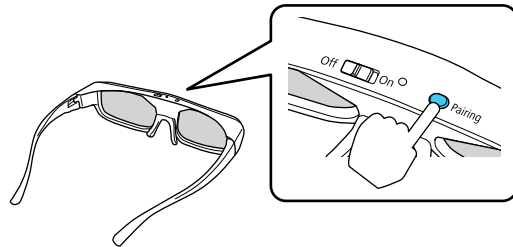

The status light on the glasses flashes green and red. If pairing is successful, the light turns green for 10 seconds and then turns off.

**Parent topic:** [Viewing 3D Images](#)

## Charging the 3D Glasses

When the status light on the glasses flashes red to indicate a low battery, it is time to charge the glasses.

1. Connect the smaller end of the charging cable to the port on the bridge of the glasses.

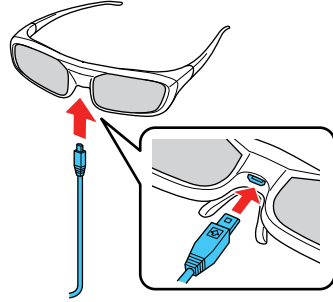

**Note:** Make sure you connect the cable in the correct orientation or you may damage the glasses or cable.

2. Do one of the following:
  - Plug the other end of the charging cable into a powered USB port on a computer or other device.
  - Plug the other end of the charging cable into a USB-to-AC adapter with the following specifications:
    - Input: 100-240V, ~0.15A, 50-60Hz
    - Output: 5V=1A

The glasses are fully charged when the status light on the glasses stays green.

**Parent topic:** [Viewing 3D Images](#)

## 3D Viewing Range

When you view 3D images, make sure you are positioned within the viewing range shown here.

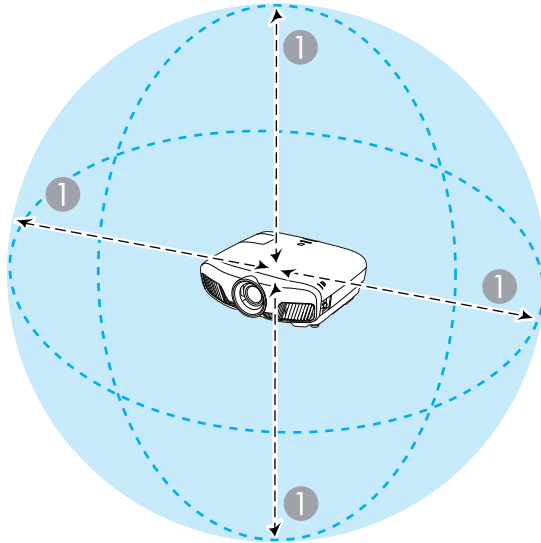

1 32 ft (10 m)

Parent topic: [Viewing 3D Images](#)

## Selecting the Language for the Projector Menus

If you want to view the projector's menus and messages in another language, you can change the Language setting.

1. Turn on the projector.
2. Press the **Menu** button.

3. Select the **Extended** menu and press **Enter**.

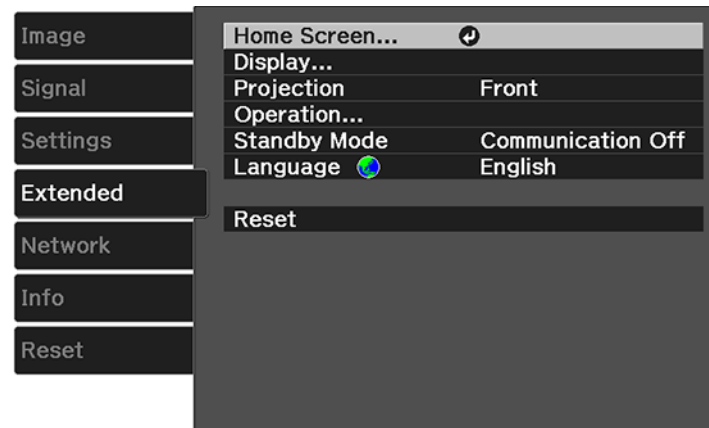

4. Select the **Language** setting and press **Enter**.
5. Select the language you want to use and press **Enter**.
6. Press **Menu** or **Esc** to exit the menus.

Parent topic: [Using Basic Projector Features](#)

## Adjusting the Image Height

If you are projecting from a table or other flat surface, and the image is too high or low, you can adjust the image height using the projector's adjustable feet.

1. Turn on the projector and display an image.
2. If the image is tilted, rotate the front feet to adjust their height.

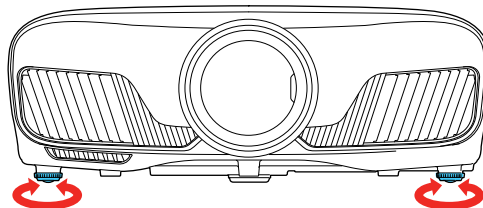

3. To adjust the position of the projected image further, press the **Lens** button on the remote control or projector until **Adjust Lens Shift** appears on the screen.

If the projected image is unevenly rectangular, you need to adjust the image shape.

**Parent topic:** [Using Basic Projector Features](#)

**Related concepts**

[Image Shape](#)

## Adjusting the Image Position Using Lens Shift

If you cannot install the projector directly in front of the screen, you can adjust the position of the projected image using the lens shift feature.

1. Turn on the projector and display an image.
2. Press the **Lens** button on the control panel or remote control.

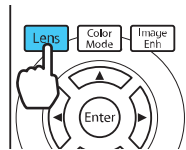

3. Press the **Lens** button repeatedly until **Adjust Lens Shift** appears on the screen.

4. Press the arrow buttons on the remote control or the control panel to adjust the position of the projected image as necessary.

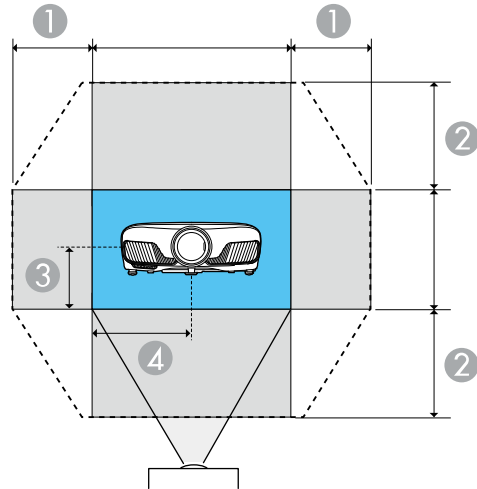

- 1 Maximum horizontal range ( $H \times 47\%$ )
- 2 Maximum vertical range ( $V \times 96\%$ )
- 3  $1/2$  the vertical height of the image
- 4  $1/2$  the horizontal width of the image

**Note:** You cannot move the image to both the horizontal and vertical maximum values.

5. When you are finished, press the **Esc** button on the control panel or remote control.

**Note:** When adjusting the image height, position the image lower than where you want it to be and then move it up. This will help prevent the image from moving down after adjustment. The image is clearest when the lens is at the home position. To move the lens to the home position, press the arrow buttons on the remote control or the control panel to move the image towards the center of the screen until it stops at the home position.

**Parent topic:** [Using Basic Projector Features](#)



## Image Shape

You can project an evenly rectangular image by placing the projector directly in front of the center of the screen and keeping it level. If you place the projector at an angle to the screen, or tilted up or down, or off to the side, you may need to correct the image shape for the best display quality.

[Correcting Image Shape With the Keystone Buttons](#)

**Parent topic:** [Using Basic Projector Features](#)

### Correcting Image Shape With the Keystone Buttons

You can use the projector's keystone correction buttons to correct the shape of an image that is unevenly rectangular on the sides.

1. Turn on the projector and display an image.

**Note:** You can display a pattern to aid in adjusting the projected image using the **Pattern** button on the remote control.

2. Press a keystone button on the projector's control panel.

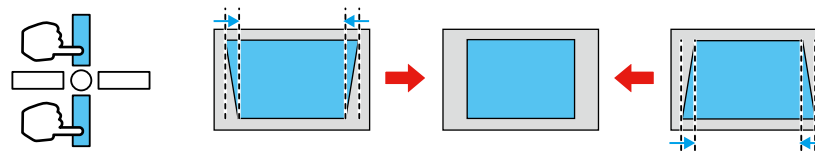

After correction, your image is slightly smaller.

**Note:** If the projector is installed out of reach, you can also correct the image shape using the Keystone settings in the projector menus.

**Parent topic:** [Image Shape](#)

**Related references**

[Projector Feature Settings - Settings Menu](#)

## Resizing the Image with the Zoom Feature

You can adjust the size of the projected image using the zoom feature.

1. Turn on the projector and display an image.
2. Press the **Lens** button on the control panel or remote control.

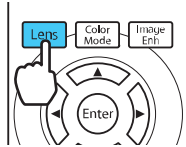

3. Press the **Lens** button repeatedly until **Adjust Zoom** is displayed on the screen.
4. Press and hold the left or right arrow button on the control panel or remote control to resize the image.
5. Press the **Esc** button on the control panel or remote control when finished.

**Parent topic:** [Using Basic Projector Features](#)

## Focusing the Image with the Lens Button

You can adjust the sharpness of the projected image using the focus feature.

**Note:** Wait 30 minutes after turning on the projector before setting the focus for maximum accuracy.

1. Turn on the projector and display an image.
2. Press the **Lens** button on the control panel or remote control.

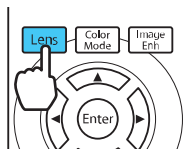

3. Press the **Lens** button repeatedly until **Adjust Focus** is displayed on the screen.
4. Press and hold the left or right arrow button on the control panel or remote control to focus the image.
5. Press the **Esc** button on the control panel or remote control when finished.

**Parent topic:** [Using Basic Projector Features](#)

## Remote Control Operation

The remote control lets you control the projector from almost anywhere in the room. You can point it at the screen, or the front or back of the projector.

Make sure that you aim the remote control at the projector's receivers within the distance and angles listed here.

### Vertical

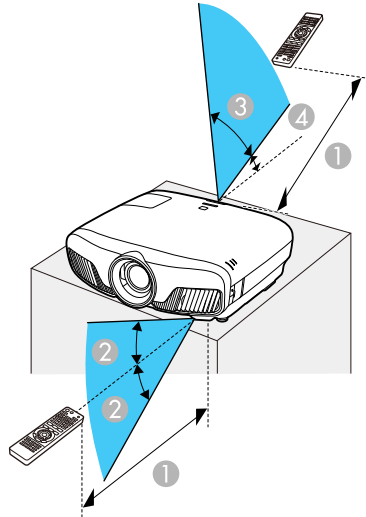

- 1 32 feet (10 m)
- 2  $\pm 30^\circ$
- 3  $60^\circ$
- 4  $10^\circ$

## Horizontal

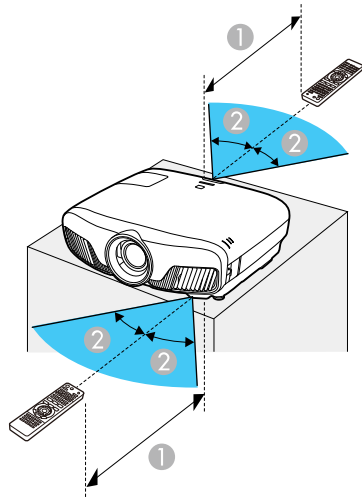

- 1 32 feet (10 m)
- 2  $\pm 30^\circ$

**Note:** Avoid using the remote control in conditions with bright fluorescent lights or in direct sunlight, or the projector may not respond to commands. If you will not use the remote control for a long time, remove the batteries.

**Parent topic:** [Using Basic Projector Features](#)

### Related tasks

[Using the Home Screen](#)

## Selecting an Image Source

If you connected multiple image sources to the projector, such as a computer and DVD player, you may want to switch from one image source to the other.

1. Make sure the connected image source you want to use is turned on.
2. For video image sources, insert a DVD or other video media and press its play button, if necessary.

3. Do one of the following:

- Press the source button on the projector until you see the image from the source you want.

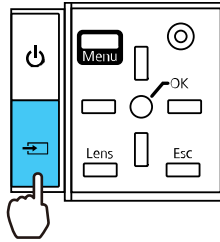

- Press the button for the source you want on the remote control.

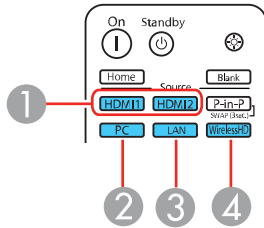

- 1 HDMI port sources
- 2 PC port (VGA) source
- 3 Network source
- 4 WirelessHD source (PowerLite Home Cinema 5040UBe)

- Press the **Home** button on the remote control and select your image source.

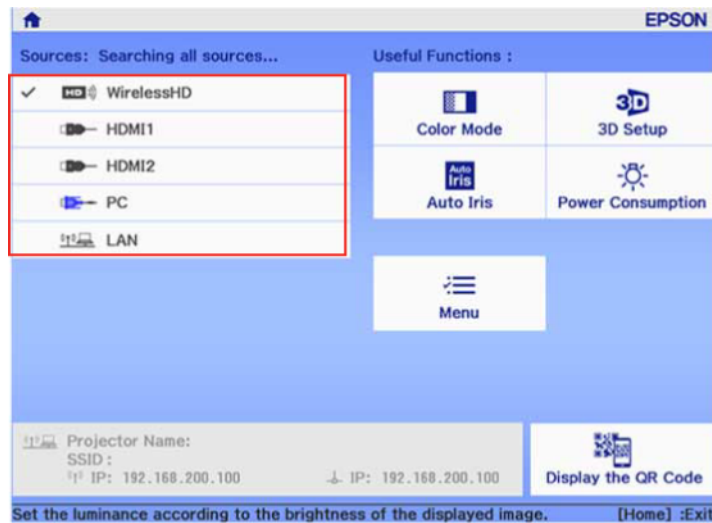

Parent topic: [Using Basic Projector Features](#)

## Projection Modes

Depending on how you positioned the projector, you may need to change the projection mode so your images project correctly.

- **Front** (default setting) lets you project from a table in front of the screen.
- **Front/Ceiling** flips the image over top-to-bottom to project upside-down from a ceiling or wall mount.
- **Rear** flips the image horizontally to project from behind a translucent screen.
- **Rear/Ceiling** flips the image over top-to-bottom and horizontally to project from the ceiling and behind a translucent screen.

[Changing the Projection Mode Using the Menus](#)

Parent topic: [Using Basic Projector Features](#)

## Changing the Projection Mode Using the Menus

You can change the projection mode to flip the image over top-to-bottom and/or left-to-right using the projector menus.

1. Turn on the projector and display an image.
2. Press the **Menu** button.
3. Select the **Extended** menu and press **Enter**.

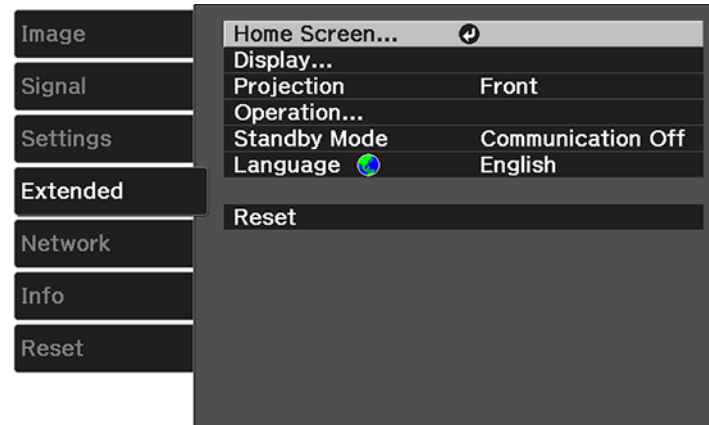

4. Select the **Projection** setting and press **Enter**.
5. Select a projection mode and press **Enter**.
6. Press **Menu** or **Esc** to exit the menus.

**Parent topic:** [Projection Modes](#)

**Related concepts**

[Projector Placement](#)

## Image Aspect Ratio

The projector can display images in different width-to-height ratios called aspect ratios. Normally the input signal from your video source determines the image's aspect ratio. However, for certain images you can change the aspect ratio to fit your screen by pressing a button on the remote control.

If you always want to use a particular aspect ratio for a certain video input source, you can select it using the projector's menus.

[Changing the Image Aspect Ratio](#)

[Available Image Aspect Ratios](#)

**Parent topic:** [Using Basic Projector Features](#)

## Changing the Image Aspect Ratio

You can change the aspect ratio of the displayed image to resize it.

**Note:** For HDMI sources, the input signal determines the image's aspect ratio.

1. Turn on the projector and switch to the image source you want to use.
2. Press the **Aspect** button on the remote control.

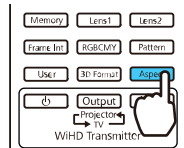

A list of the available aspect ratios appears.

3. To cycle through the available aspect ratios for your input signal, press the up or down arrow button.
4. Press **Enter** to select the aspect ratio.

**Parent topic:** [Image Aspect Ratio](#)

## Available Image Aspect Ratios

You can select the following image aspect ratios, depending on the input signal from your image source.

**Note:** When the projector is in 3D mode, the aspect ratio is automatically set to **Normal**.

**Note:** Black bands and cropped images may project in certain aspect ratios, depending on the aspect ratio and resolution of your input signal.

Aspect ratio setting	Description
<b>Auto</b>	Automatically sets the aspect ratio according to the input signal.
<b>Normal</b>	Displays images using the full projection area and maintains the aspect ratio of the image.
<b>Zoom</b>	Displays images using the full width of the projection area and maintains the aspect ratio of the image.



Aspect ratio setting	Description
Full	Displays images using the full width of the projection area, but does not maintain the aspect ratio.

**Note:** When projecting a 4K signal, you can select only **Normal** as the aspect ratio setting.

Parent topic: [Image Aspect Ratio](#)

## Color Mode

The projector offers different Color Modes to provide optimum brightness, contrast, and color for a variety of viewing environments and image types. You can select a mode designed to match your image and environment, or experiment with the available modes.

If you always want to use a particular color mode for a certain video input source, you can select it using the projector menus.

[Changing the Color Mode](#)

[Available Color Modes](#)

[Turning On Auto Iris](#)

Parent topic: [Using Basic Projector Features](#)

## Changing the Color Mode

You can change the projector's Color Mode using the remote control to optimize the image for your viewing environment.

1. Turn on the projector and switch to the image source you want to use.
2. If you are projecting from a DVD player or other video source, insert a disc or other video media and press the play button, if necessary.
3. Press the **Color Mode** button on the remote control to change the Color Mode.

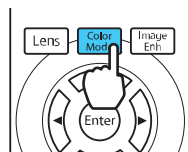

A list of available Color Modes appears.

4. To cycle through all the available Color Modes for your input signal, press the up or down arrow button.
5. Press **Enter** to select a Color Mode.

Parent topic: [Color Mode](#)

## Available Color Modes

You can set the projector to use these Color Modes, depending on the input source you are using:

### 2D Images

Color Mode	Description
<b>Dynamic</b>	Best for projecting in a bright room
<b>Natural</b>	Best for projecting in a dark room
<b>Bright Cinema</b>	Best for projecting in a room with closed curtains
<b>Cinema</b>	Best for projecting color movies in a dark room
<b>B&amp;W Cinema</b>	Best for projecting black and white movies in a dark room
<b>Digital Cinema</b>	Projects using the same color spectrum as digital movie theaters

### 3D Images

Color Mode	Description
<b>3D Dynamic</b>	Best for projecting in a bright room
<b>3D Cinema</b>	Best for projecting movies in a dark room

Parent topic: [Color Mode](#)

## Turning On Auto Iris

In certain color modes, you can turn on the Auto Iris setting to automatically optimize the image based on the brightness of the content you project.

1. Turn on the projector and switch to the image source you want to use.
2. Press the **Menu** button.

3. Select the **Image** menu and press **Enter**.

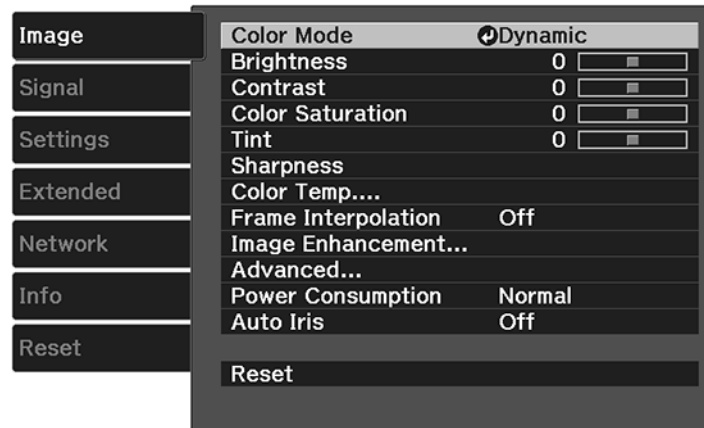

4. Select the **Auto Iris** setting and choose one of the following:
  - **High Speed** to adjust brightness as soon as the scene changes.
  - **Normal** for standard brightness adjustment.

**Note:** You can set **Auto Iris** for each Color Mode that supports the feature.

5. Press **Menu** or **Esc** to exit the menus.

**Parent topic:** [Color Mode](#)

---

# Adjusting Projector Features

Follow the instructions in these sections to use your projector's feature adjustments.

[Shutting Off the Picture Temporarily](#)

[Using Picture in Picture](#)

[Adjusting the Color Convergence \(Panel Alignment\)](#)

[Adjusting the Color Tone \(Color Uniformity\)](#)

[Projector Security Features](#)

[Saving Settings to Memory and Using Saved Settings](#)

[Saving the Lens Position and Using Saved Lens Positions](#)

## Shutting Off the Picture Temporarily

You can temporarily turn off the projected picture if you want to redirect your audience's attention during a presentation. Any video action continues to run, however, so you cannot resume projection at the point that you stopped it.

1. Press the **Blank** button on the remote control to temporarily stop projection.

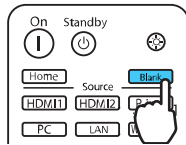

2. To turn the picture back on, press the **Blank** button again.

**Parent topic:** [Adjusting Projector Features](#)

## Using Picture in Picture

You can use Picture in Picture mode to view two image sources simultaneously.

**Note:** You can display only HDMI or WirelessHD (PowerLite Home Cinema 5040UBe) video sources when using Picture in Picture mode. You cannot use Picture in Picture while projecting 3D or 4K images.

1. Turn on the projector and switch to the HDMI or WirelessHD image source you want to use.

2. Press the **P-in-P** button on the remote control.

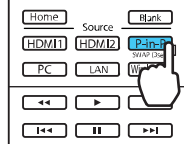

The second HDMI video source appears as a sub-screen in the corner of the image.

**Note:** While Picture in Picture mode is active, press the **Menu** button on the remote control to adjust the size and position of the sub-screen.

3. To swap the main screen and sub-screen video sources, press and hold the **P-in-P** button for at least three seconds.
4. Press the **P-in-P** button again to close the sub-screen and resume normal projection.

[Available Picture in Picture Options](#)

**Parent topic:** [Adjusting Projector Features](#)

## Available Picture in Picture Options

You can adjust the following options by pressing the **Menu** button on the remote control while Picture in Picture mode is active:

Setting	Description
<b>Subscreen Size</b>	Adjusts the size of the sub-screen
<b>Subscreen Position</b>	Adjusts the location where the sub-screen is displayed
<b>Subscreen Source</b>	Selects which source appears in the sub-screen
<b>Swap Main/Sub</b>	Switches the video source displayed on the main screen with the source displayed on the sub-screen
<b>Exit Picture in Picture</b>	Closes the sub-screen and resumes normal projection

**Parent topic:** [Using Picture in Picture](#)

## Adjusting the Color Convergence (Panel Alignment)

You can use the Panel Alignment feature to manually adjust the color convergence (the alignment of the red, green and blue colors) in the projected image.

**Note:** Allow your projector to warm up for at least 10 to 15 minutes and make sure the image is in focus before you use the Panel Alignment feature. The projected image should be a minimum of 60 inches (152 cm) diagonally and the projection surface should not be colored or textured, otherwise the adjustment grids will be difficult to align.

1. Turn on the projector.
2. Press the **Menu** button.
3. Select the **Settings** menu and press **Enter**.
4. Select the **Panel Alignment** setting and press **Enter**.

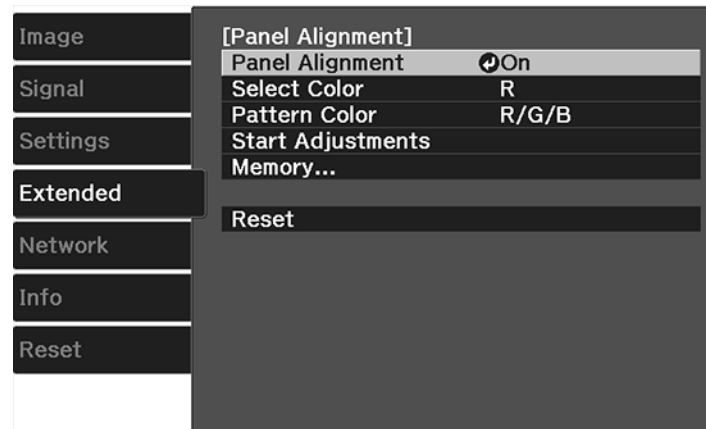

5. Select the **Panel Alignment** setting and press **Enter**.
6. Select **On** and press **Enter**.
7. Select the **Select Color** setting and choose one of the following:
  - **R** to adjust the red color convergence.

- **B** to adjust the blue color convergence.

**Note:** You can only adjust the red or blue color convergence. Green is the standard color panel and cannot be adjusted.

8. Select the **Pattern Color** setting and press **Enter**.
9. Select the pattern you want to use and press **Enter**.
10. Select **Start Adjustments** and press **Enter**.

You see this screen:

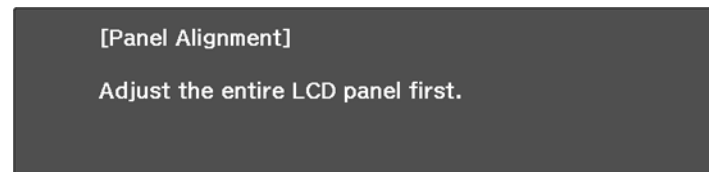

11. Press **Enter**.

You see a screen like this:

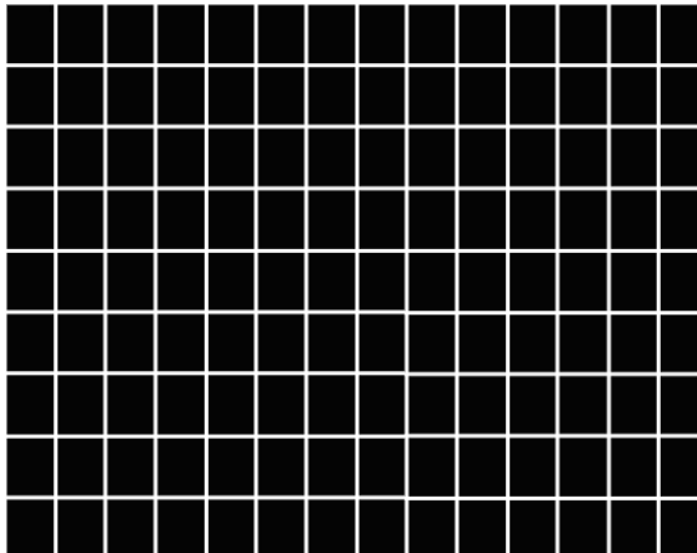

12. Use the arrow buttons on the remote control to adjust the color alignment of the color you selected for the **Select Color** setting.

**Note:** Your adjustments affect the gridlines in the entire screen. You can fine-tune your adjustments by continuing with the next steps.

13. When you are finished adjusting the screen, press **Enter**.

You see this screen:

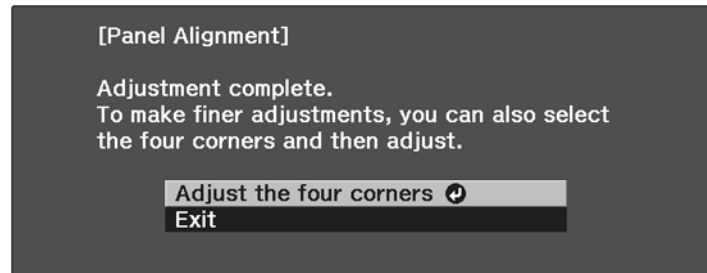

14. Select **Adjust the four corners** and press **Enter**.
15. Use the arrow buttons on the remote control to adjust the color alignment in the corner of the screen highlighted by the orange box.

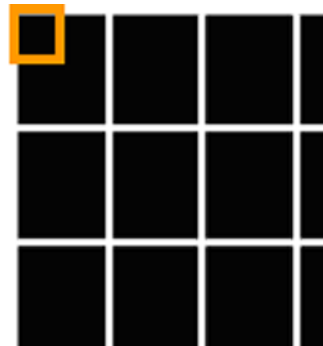

16. Press the **Enter** button to move to the next corner of the screen.
17. When you are finished adjusting each corner of the screen, press **Enter**.



You see this screen:

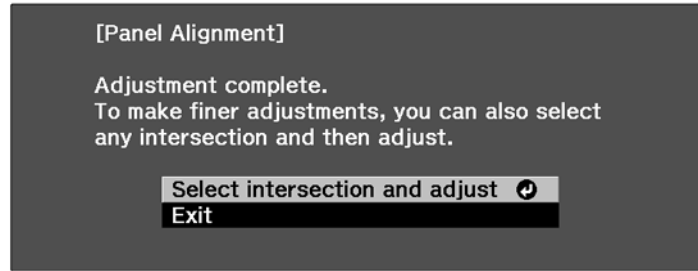

18. Do one of the following:

- If your projector's panel alignment is now correct, select **Exit** and press **Enter** to return to the Panel Alignment menu.
- If your projector needs additional panel alignment, select **Select intersection and adjust** and press **Enter**. Use the arrow keys on the remote control to highlight the corner of any box on the screen that is misaligned and press **Enter** to adjust the color convergence. Repeat this step as necessary.

Parent topic: [Adjusting Projector Features](#)

## Adjusting the Color Tone (Color Uniformity)

You can use the Color Uniformity feature to manually adjust the color tone balance in the projected image.

1. Press the **Menu** button.

2. Select the **Extended** menu and press **Enter**.

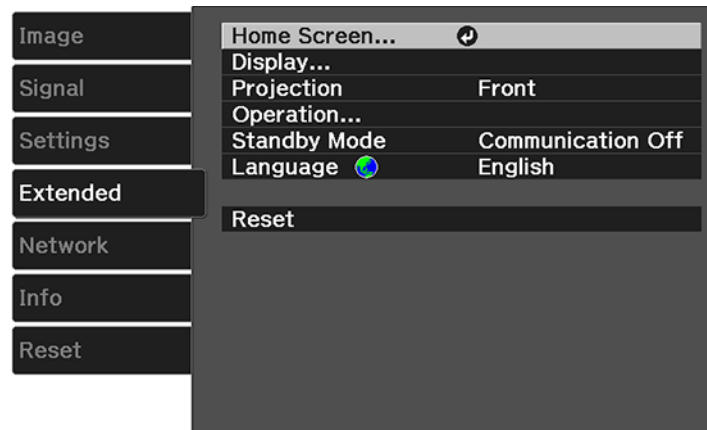

3. Select the **Display** setting and press **Enter**.
4. Select the **Color Uniformity** setting and press **Enter**.
5. Press **Enter** and select **On**.
6. Press **Esc**.
7. Select the **Adjustment Level** setting and press **Enter**.
8. Press the right and left arrow buttons to adjust the level, then press **Esc**.
9. Select the **Start Adjustments** setting and press **Enter**.

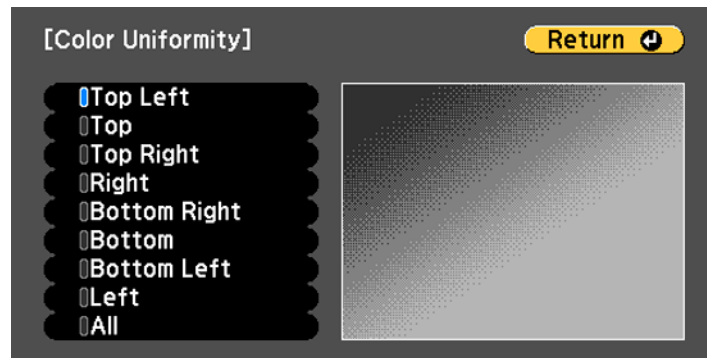

10. Select the area of the screen that you want to adjust and press **Enter**.
11. Select the color (**Red**, **Green**, or **Blue**) you want to adjust, and use the left arrow button to weaken the color tone and the right arrow button to strengthen the color tone.
12. Press **Esc**.
13. Repeat steps 10 and 11 for each area you want to adjust.
14. When you are finished, press the **Menu** button.

**Parent topic:** [Adjusting Projector Features](#)

## Projector Security Features

You can secure your projector to deter theft or prevent unintended use by setting up the following security features:

- Lens lock to prevent changing the zoom, focus, or lens shift settings.
- Button lock security to block operation of the projector using the buttons on the control panel.
- Security cabling to physically cable the projector in place.

[Locking the Projector's Lens Settings and Buttons](#)

[Installing a Security Cable](#)

**Parent topic:** [Adjusting Projector Features](#)

## Locking the Projector's Lens Settings and Buttons

You can lock the buttons on the projector's control panel to prevent anyone from using the projector. You can also lock the zoom, focus, and lens shift settings to prevent them from being adjusted.

**Note:** You can use the remote control to control the projector when the control panel buttons are locked.

1. Press the **Menu** button.

2. Select the **Settings** menu and press **Enter**.

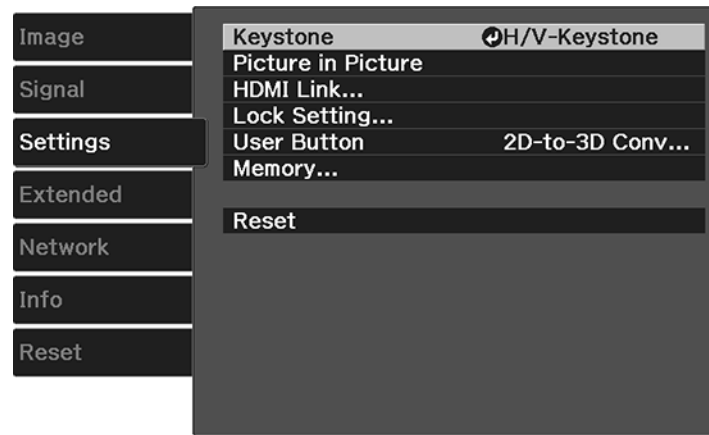

3. Select the **Lock Setting** setting and press **Enter**.
4. Select one of these lock types and press **Enter**:
  - To lock the zoom, focus, and lens shift settings, select **Lens Lock**.
  - To lock the projector's power button, select **Child Lock**. To turn the projector on, you must press the power button for longer than three seconds.

**Note:** **Child Lock** does not prevent the projector from turning on when the power cord is connected if the **Direct Power On Setting** is set to **On**.

- To lock all buttons, select **Control Panel Lock > Full Lock**.
- To lock all buttons except the power button, select **Control Panel Lock > Partial Lock**.

**Note:** The  lock icon is displayed on the screen if any control panel buttons are pressed while this setting is enabled.

You see a confirmation prompt.

5. Select **Yes** and press **Enter**.
6. Restart the projector for the lock settings to take effect.

[Unlocking the Projector's Buttons](#)

**Parent topic:** [Projector Security Features](#)

**Related references**

[Projector Feature Settings - Settings Menu](#)

### Unlocking the Projector's Buttons

If the projector's buttons have been locked, hold the **OK** button on the projector's control panel for seven seconds to unlock them.

**Parent topic:** [Locking the Projector's Lens Settings and Buttons](#)

### Installing a Security Cable

You can use the security slot on the back of the projector to attach a Kensington lock. See your local computer or electronics dealer for purchase information.

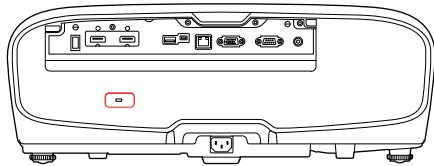

**Parent topic:** [Projector Security Features](#)

### Saving Settings to Memory and Using Saved Settings

You can save customized settings for each of your video inputs and then select the saved settings whenever you want to use them.

1. Turn on the projector and display an image.
2. Press the **Menu** button.

**Note:** You can also press the **Memory** button on the remote control to access the Memory menu directly.

3. Select the **Settings** menu and press **Enter**.
4. Select the **Memory** setting and press **Enter**.

You see this screen:

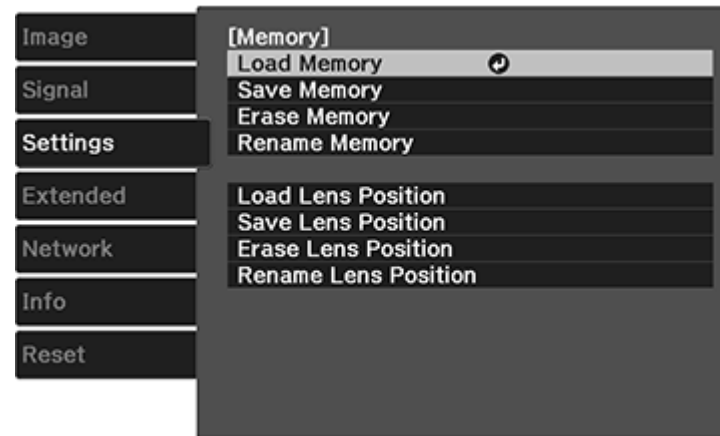

5. Select one of the following options:

- **Load Memory:** Overwrites your current settings with saved settings
- **Save Memory:** Saves your current settings to memory (10 memories with different names are available)

**Note:** A memory name that has already been used is indicated by a blue mark. Saving over a previously saved memory overwrites the settings with your current settings.

- **Erase Memory:** Erases the selected memory settings
- **Rename Memory:** Renames a saved memory

6. Press **Esc** to exit.

**Parent topic:** [Adjusting Projector Features](#)

## Saving the Lens Position and Using Saved Lens Positions

You can save the focus, zoom, and lens shift settings and then select the saved settings whenever you want to use them.

1. Turn on the projector and display an image.
2. Adjust the focus, zoom, and lens shift settings.

3. Press the **Menu** button.

**Note:** You can also press the **Memory** button on the remote control to access the Memory menu directly.

4. Select the **Settings** menu and press **Enter**.
5. Select the **Memory** setting and press **Enter**.

You see this screen:

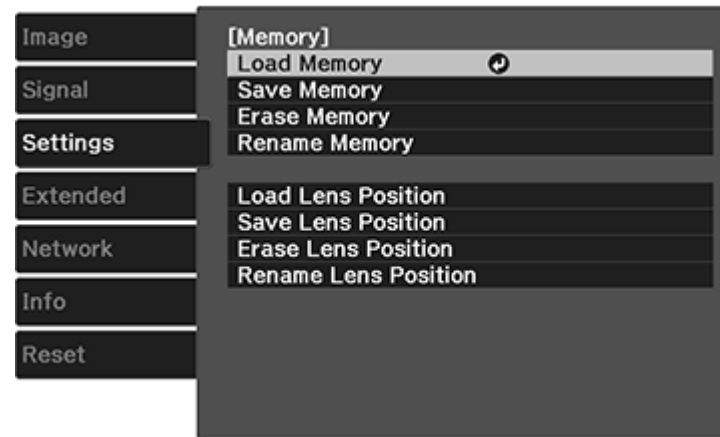

6. Select one of the following options:

- **Load Lens Position:** Overwrites your current focus, zoom, and lens shift settings with saved settings

**Note:** You can load the saved settings from **Memory1** or **Memory2** by pressing the **Lens1** or **Lens2** buttons on the remote control.

- **Save Lens Position:** Saves your current focus, zoom, and lens shift settings to memory (10 memories with different names are available)

**Note:** A memory name that has already been used is indicated by a blue mark. Saving over a previously saved memory overwrites the settings with your current settings.

- **Erase Lens Position:** Erases the selected lens position settings

- **Rename Lens Position:** Renames a saved lens position (12 characters maximum)

7. Press **Esc** to exit.

**Parent topic:** [Adjusting Projector Features](#)



---

# Using WirelessHD

You can use the included WirelessHD transmitter to wirelessly stream HD content from a video device to the projector (PowerLite Home Cinema 5040UBe).

[WirelessHD Transmitter Parts](#)

[WirelessHD Transmission Range](#)

[WirelessHD Remote Control Operation](#)

[Connecting the WirelessHD Transmitter](#)

[Viewing WirelessHD Content](#)

[Switching WirelessHD Sources](#)

## WirelessHD Transmitter Parts

Front

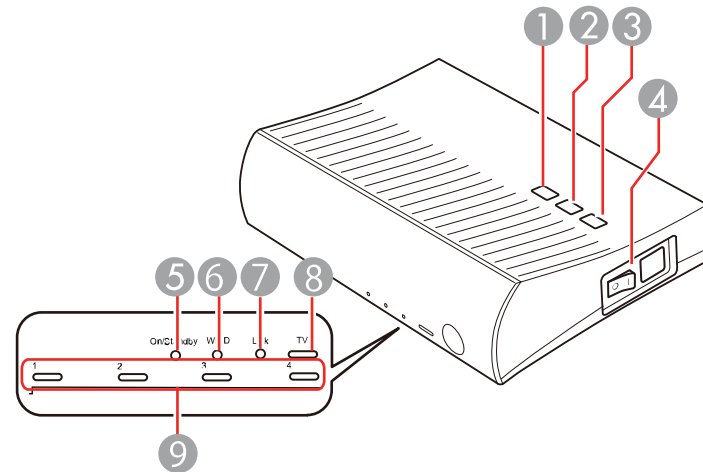

- 1 power button (turns the transmitter on or off)
- 2 **Input** button (cycles through image sources)
- 3 **WiHD/Pass** button (cycles output signal between the projector and a display device connected to the transmitter's **HDMI Out** port)

- 4 Power switch (turns the transmitter on or off)
- 5 **On/Standby** light (flashes when starting up; lit when the transmitter is on)
- 6 **WiHD** light (lit when sending a wireless signal to the projector)
- 7 **Link** light (lit when connected to the projector; flashing when searching for the projector or when on standby)
- 8 **TV** light (lit when the **HDMI Out** port is selected as the output)
- 9 1-4 (HDMI1 through HDMI4) lights (lit when the port is being projected)

### Back

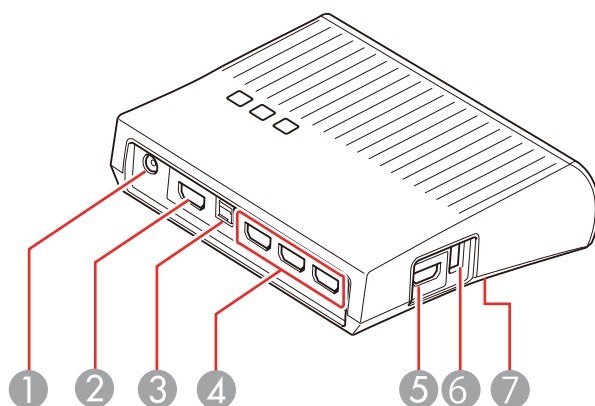

- 1 AC input port (connects the AC adapter)
- 2 **HDMI Out** port (connects to display devices such as a television)
- 3 **Optical Audio-Out** port (connects to devices with an optical digital audio input port)
- 4 **HDMI1-HDMI3** input ports (connect to your input devices)
- 5 **HDMI4** port (connects to your input device; supports MHL connections)
- 6 3D glasses charging port (connects a USB cable to charge 3D glasses)
- 7 **Setup** button (press for 5 seconds to reset the transmitter settings)

Parent topic: [Using WirelessHD](#)

## WirelessHD Transmission Range

Place the WirelessHD Transmitter within the distance and angles shown here. Make sure the front of the WirelessHD Transmitter faces the front of the projector. Place the WirelessHD transmitter on a wooden shelf or other location that does not block the signal.

### Vertical (on surface)

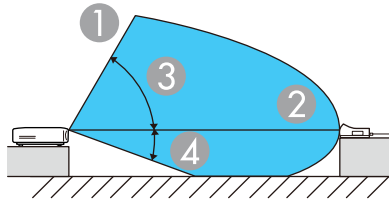

- 1 16 feet (5 m)
- 2 32 feet (10 m)
- 3 60°
- 4 30°

### Vertical (inverted on ceiling)

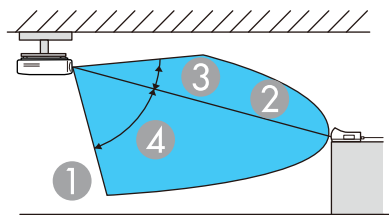

- 1 16 feet (5 m)
- 2 32 feet (10 m)
- 3 30°
- 4 60°

## Horizontal

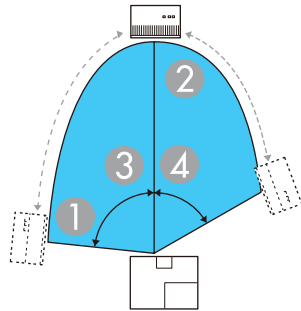

- 1 16 feet (5 m)
- 2 32 feet (10 m)
- 3 70°
- 4 45°

When positioning the WirelessHD transmitter, note the following:

- The wireless transmission range varies depending on the placement and material of the furniture and walls. The values provided here are for your reference only.
- The projector cannot communicate through walls.
- When checking the signal, place the projector and WirelessHD Transmitter close to each other and make sure there are no other projectors operating nearby.
- Depending on the signal strength, the image's color information may be automatically discarded to avoid any interruptions and maintain a constant connection. To avoid any deterioration in image quality, adjust the position of the transmitter so that the **Video Reception** setting is as strong as possible. If no image is being input, the **Video Reception** setting displays **0%**, even if the projector and transmitter are connected.
- Reception sensitivity varies depending on the resolution of the input image.

**Parent topic:** [Using WirelessHD](#)

## WirelessHD Remote Control Operation

The remote control lets you control the WirelessHD transmitter from almost anywhere in the room. Make sure that you aim the remote control at the WirelessHD transmitter's remote receiver within the distance and angles shown here.

### Vertical

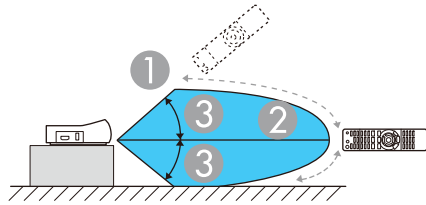

- 1 13 feet (4 m)
- 2 65.6 feet (20 m)
- 3  $\pm 40^\circ$

### Horizontal

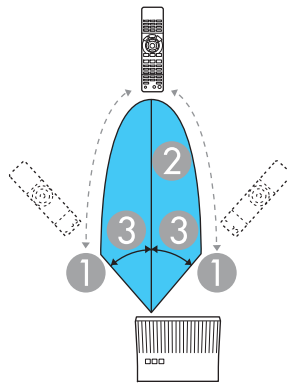

- 1 13 feet (4 m)
- 2 65.6 feet (20 m)

3 ± 40°

**Note:** Avoid using the remote control in conditions with bright fluorescent lights or in direct sunlight, or the projector may not respond to commands. If you will not use the remote control for a long time, remove the batteries.

Parent topic: [Using WirelessHD](#)

## Connecting the WirelessHD Transmitter

You can connect up to four HDMI input sources and one HDMI output source to your WirelessHD transmitter.

1. Plug the AC adapter into the AC input port on the WirelessHD transmitter and into an electrical outlet.

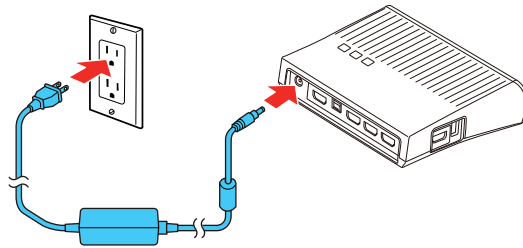

2. Connect HDMI cables to your video devices and to the HDMI input ports on the side and back of the WirelessHD transmitter.

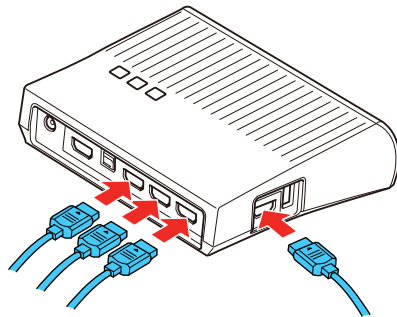

**Note:** You can connect an MHL-compatible smartphone or tablet to the **HDMI4** port on the WirelessHD Transmitter.

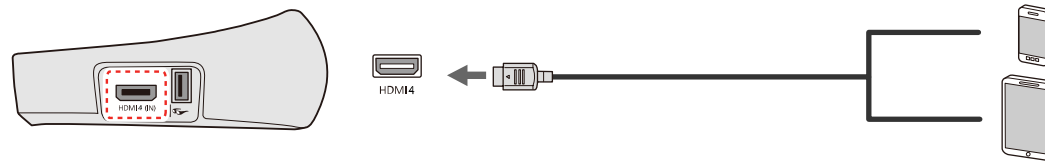

3. To use the WirelessHD transmitter as a pass-through device to a television or other display, connect an HDMI cable to the display device and to the **HDMI Out** port on the back of the transmitter.

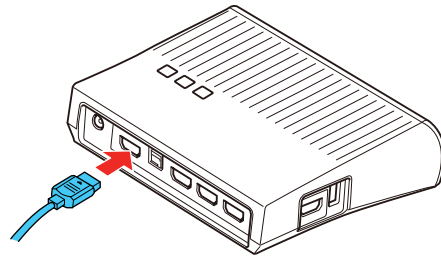

Parent topic: [Using WirelessHD](#)

## Viewing WirelessHD Content

You can project content wirelessly from any device connected to the WirelessHD transmitter.

1. Turn on the video equipment or computer you connected to the transmitter and want to project from.
2. Press the power switch on the side of the transmitter to turn on the transmitter.
3. Turn on the projector.
4. Press the **WirelessHD** button on the remote control.

The **WiHD** light on the transmitter turns on and your projector displays content wirelessly.

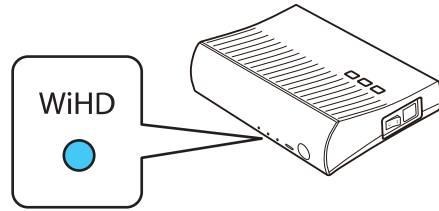

**Note:** If the WirelessHD connection fails, press the **Setup** button on the bottom of the WirelessHD transmitter and try again.

Parent topic: [Using WirelessHD](#)

## Switching WirelessHD Sources

If you have connected multiple HDMI input sources to your WirelessHD transmitter, you can use the projector remote control to switch between sources.

1. Aim the remote control at the WirelessHD transmitter.



2. Press the **Input** button on the remote control or the WirelessHD transmitter repeatedly to select the input source you want.

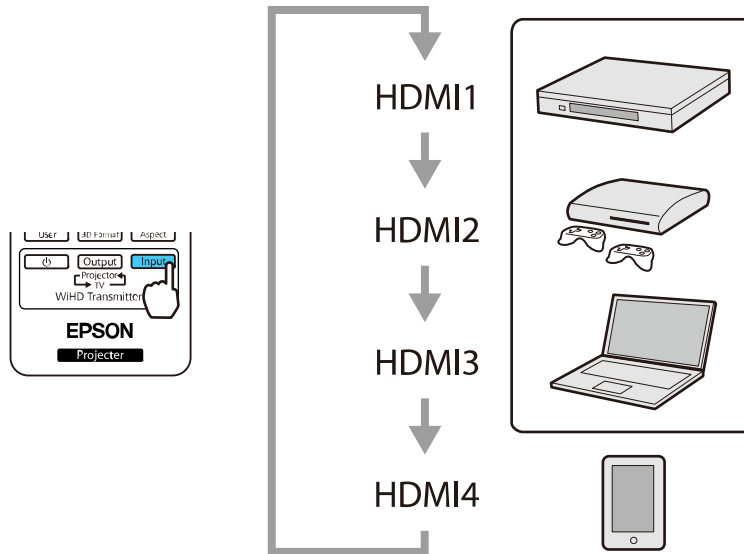

After a few seconds, the display switches to the selected source.

**Parent topic:** [Using WirelessHD](#)

---

# Adjusting the Menu Settings

Follow the instructions in these sections to access the projector menu system and change projector settings.

[Using the Projector's Menus](#)

[Image Quality Settings - Image Menu](#)

[Input Signal Settings - Signal Menu](#)

[Projector Feature Settings - Settings Menu](#)

[Projector Setup Settings - Extended Menu](#)

[Projector Network Settings - Network Menu](#)

[Projector Information Display - Info Menu](#)

[Projector Reset Options - Reset Menu](#)

## Using the Projector's Menus

You can use the projector's menus to adjust the settings that control how your projector works. The projector displays the menus on the screen.

1. Press the **Menu** button on the control panel or remote control.

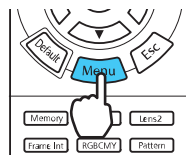
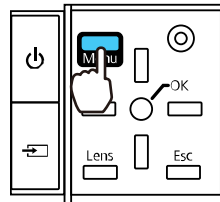

You see the menu screen displaying the Image menu settings.

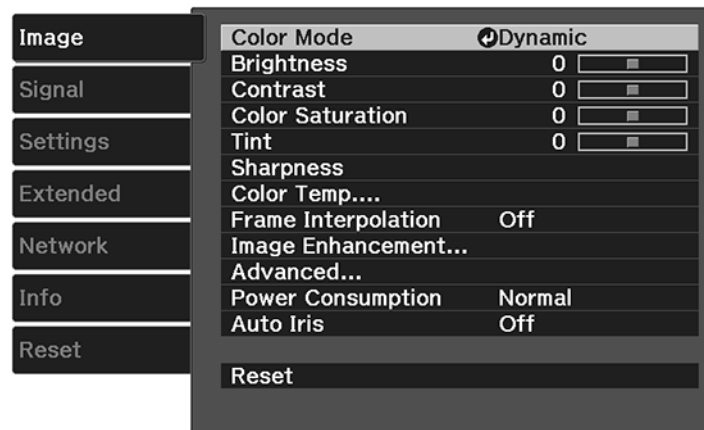

2. Press the up or down arrow button to move through the menus listed on the left. The settings for each menu are displayed on the right.

**Note:** The available settings depend on the current input source.

3. To change settings in the displayed menu, press **Enter** or **OK**.
4. Press the up or down arrow button to move through the settings.
5. Change the settings using the buttons listed on the bottom of the menu screens.
6. To return all the menu settings to their default values, select **Reset**.
7. When you finish changing settings on a menu, press **Esc**.
8. Press **Menu** or **Esc** to exit the menus.

**Parent topic:** [Adjusting the Menu Settings](#)

## Image Quality Settings - Image Menu

Settings on the Image menu let you adjust the quality of your image for the input source you are currently using.

**Note:** The available settings depend on the currently selected input source.

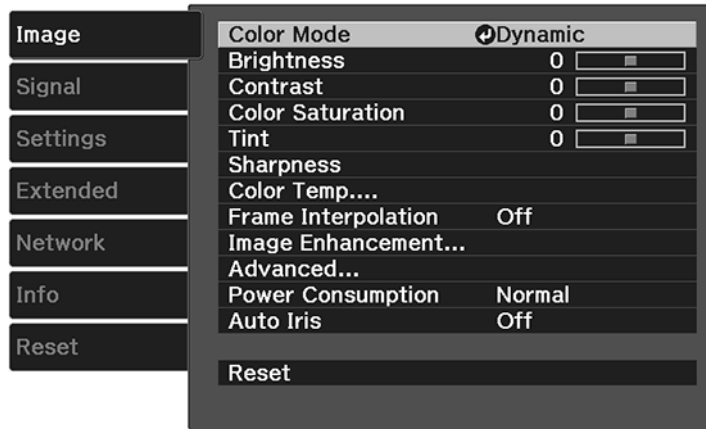

To change settings for an input source, make sure the source is connected and select that source.

Setting	Options	Description
<b>Color Mode</b>	See the list of available Color Modes	Adjusts the vividness of image colors for various image types and environments
<b>Brightness</b>	Varying levels available	Lightens or darkens the overall image
<b>Contrast</b>	Varying levels available	Adjusts the difference between light and dark areas of the image
<b>Color Saturation</b>	Varying levels available	Adjusts the intensity of the image colors
<b>Tint</b>	Varying levels available	Adjusts the balance of green to magenta tones in the image
<b>Sharpness</b>	Varying levels available	Adjusts the sharpness or softness of image details

Setting	Options	Description
<b>Color Temp.</b> (color temperature)	<b>Color Temp.</b> <b>Skin Tone</b> <b>Customized</b>	<p><b>Color Temp.:</b> sets the overall color tone; higher values tint the image blue and lower values tint the image red</p> <p><b>Skin Tone:</b> makes fine adjustments to the color tone; higher values tint the image green and lower values tint the image red</p> <p><b>Customized:</b> adjusts the offset and gain for each RGB color</p>
<b>Frame Interpolation</b>	<b>Off</b> <b>Weak</b> <b>Normal</b> <b>Strong</b>	Adjusts the smoothness of movement in the image

Setting	Options	Description
Image Enhancement	<b>4K Enhancement</b> <b>Image Preset Mode</b> <b>Noise Reduction</b> <b>MPEG Noise Reduction</b> <b>Super-resolution</b> <b>Detail Enhancement</b>	<p><b>4K Enhancement:</b> accepts 4K signals and enhances the output of 1080p signals</p> <p><b>Image Preset Mode:</b> selects one of five preset groups of settings for the next image enhancement options</p> <p><b>Noise Reduction:</b> reduces flickering in analog images</p> <p><b>MPEG Noise Reduction:</b> reduces the noise or artifacts seen in MPEG video</p> <p><b>Super-resolution:</b> sharpens blurred images resulting from increasing resolution</p> <p><b>Detail Enhancement:</b> enhances details to create clear outlines</p> <ul style="list-style-type: none"> <li>• <b>Range:</b> higher settings increase the affected area around the outline</li> <li>• <b>Strength:</b> higher settings create a stronger effect</li> </ul> <p><b>Note:</b> <b>Range</b> and <b>Strength</b> will vary based on the <b>Image Preset Mode</b> setting.</p>

Setting	Options	Description
Advanced	<b>Gamma</b> <b>RGBCMY</b> <b>Deinterlacing</b> <b>EPSON Super White</b> <b>Lens Iris</b> (PowerLite Pro Cinema 6040UB)	Selects various detailed color settings <b>Gamma:</b> adjusts the gamma levels of the image. Select <b>Customized</b> to adjust the gamma while viewing the image or a graph. <b>RGBCMY:</b> adjusts the hue, saturation, and brightness for each color <b>Deinterlacing:</b> sets whether to convert interlaced-to-progressive signals for certain video image types <ul style="list-style-type: none"> <li>• <b>Off:</b> for fast-moving video images</li> <li>• <b>Video:</b> for most video images</li> <li>• <b>Film/Auto:</b> for movies, computer graphics, and animation</li> </ul> <b>EPSON Super White:</b> reduces over-exposure of whites in your image <b>Lens Iris:</b> adjusts the contrast of the image by adjusting the amount of light entering the lens

Setting	Options	Description
<b>Power Consumption</b>	<b>High</b> <b>Medium</b> <b>ECO</b>	Selects the brightness mode of the projector lamp  <b>High:</b> sets maximum lamp brightness  <b>Medium:</b> reduces the brightness of the lamp  <b>ECO:</b> reduces lamp brightness and fan noise, and saves power and lamp life
<b>Auto Iris</b>	<b>Off</b> <b>Normal</b> <b>High Speed</b>	Adjusts the projected luminance based on the image brightness when certain Color Modes are selected

**Note:** The **Brightness** setting does not affect lamp brightness. To change the lamp brightness mode, use the **Power Consumption** setting.

**Parent topic:** [Adjusting the Menu Settings](#)

**Related references**

[Available Color Modes](#)

## Input Signal Settings - Signal Menu

Normally the projector detects and optimizes the input signal settings automatically. If you need to customize the settings, you can use the Signal menu.



**Note:** The available settings depend on the currently selected input source. You cannot change the **Signal** menu settings when the **LAN** source is selected.

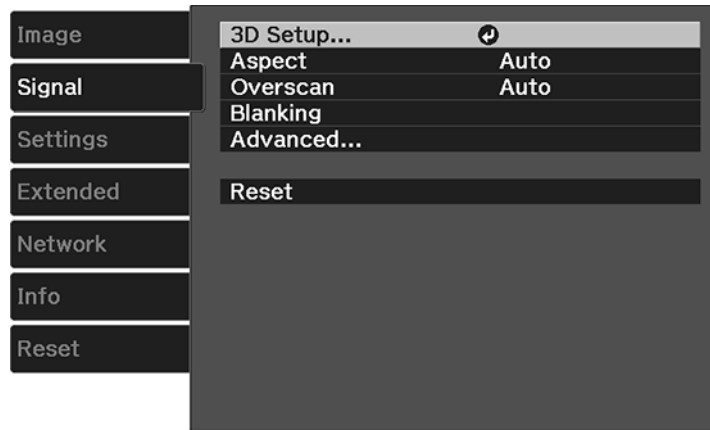

To change settings for an input source, make sure the source is connected and select that source.

Setting	Options	Description
<b>3D Setup</b>	<b>3D Display</b> <b>3D Format</b> <b>2D-to-3D Conversion</b> <b>3D Depth</b> <b>Diagonal Screen Size</b> <b>3D Brightness</b> <b>Inverse 3D Glasses</b> <b>3D Viewing Notice</b>	Selects various 3D options <b>3D Display:</b> enables 3D mode <b>3D Format:</b> selects the 3D format <b>2D-to-3D Conversion:</b> converts 2D images to 3D <b>3D Depth:</b> sets the depth for the 3D image <b>Diagonal Screen Size:</b> selects the actual size of the screen to maximize the 3D effect <b>3D Brightness:</b> adjusts the brightness of the 3D image <b>Inverse 3D Glasses:</b> reverses the images projected for the left and right eyes (enable only if 3D images do not display correctly) <b>3D Viewing Notice:</b> enables the viewing notice displayed when using 3D mode
<b>Aspect</b>	See the list of available aspect ratios	Sets the aspect ratio (width-to-height ratio) for the selected input source
<b>Tracking</b>	Varying levels available	Adjusts signal to eliminate vertical stripes in computer images from the PC input port
<b>Sync.</b>	Varying levels available	Adjusts signal to eliminate fuzziness or flickering in computer images from the PC input port
<b>Position</b>	Up, down, left, right	Adjusts the image location on the screen

Setting	Options	Description
<b>Auto Setup</b>	<b>On</b> <b>Off</b>	Automatically optimizes computer image quality
<b>Overscan</b>	<b>Auto</b> <b>Off</b> <b>4%</b> <b>8%</b>	Changes the projected image ratio to make the edges visible by a selectable percentage or automatically
<b>Blanking</b>	Various settings	Covers part of the image with a black screen to hide raster lines at the edge of the screen.  <b>Note:</b> Using this feature reduces the image size.
<b>Advanced</b>	<b>HDMI Video Range</b> <b>Color Space</b> <b>Dynamic Range</b> <b>Image Processing</b>	<b>HDMI Video Range:</b> sets the video range to match the setting of the device connected to the HDMI input port <b>Color Space:</b> sets the conversion system for the color space ( <b>Auto</b> , <b>BT.709</b> , or <b>BT.2020</b> ) <b>Dynamic Range:</b> selects the HDR (High Dynamic Range) mode <b>Image Processing:</b> adjusts how images are processed; select <b>Fast</b> to display images quicker; select <b>Fine</b> to display images in higher quality

**Note:**

- You can set the HDMI Video Range setting only when the **Epson Super White** setting is set to **Off**.
- The **Reset** setting does not reset the **Diagonal Screen Size**, **3D Viewing Notice**, and **Aspect** settings.

- The **Aspect** setting is not available for HD video signals.

**Parent topic:** [Adjusting the Menu Settings](#)

**Related concepts**

[Image Aspect Ratio](#)

**Related tasks**

[Viewing 3D Images](#)

## Projector Feature Settings - Settings Menu

Options on the Settings menu let you customize various projector features.

PowerLite Home Cinema 5040UB:

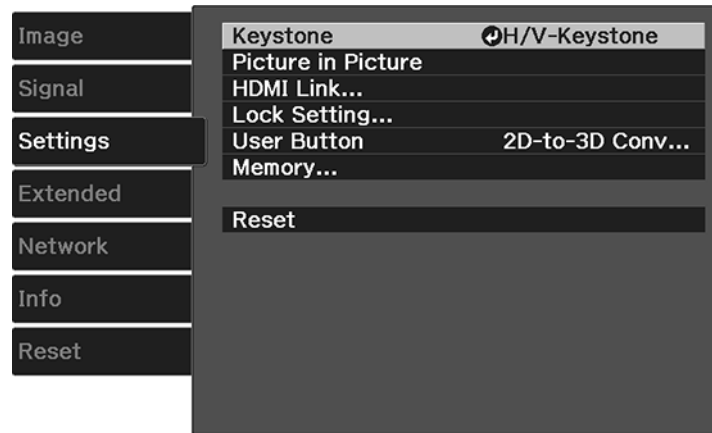

PowerLite Home Cinema 5040UBe:

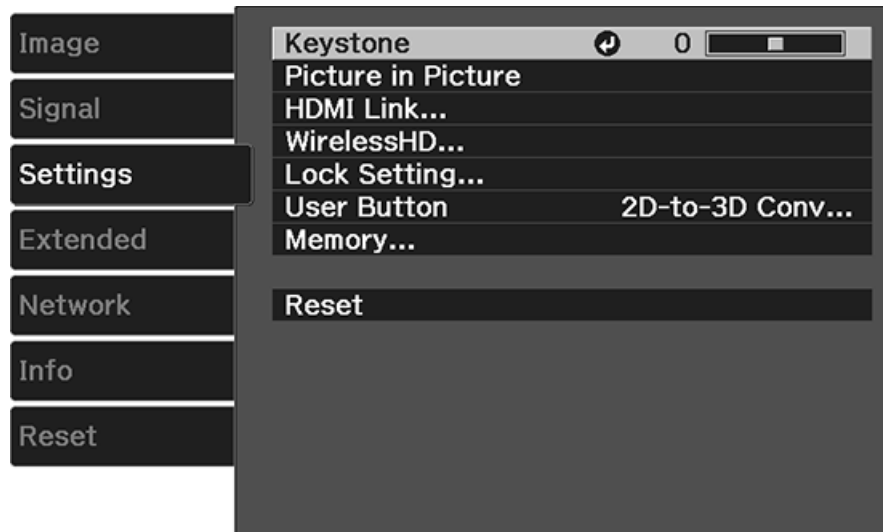

Setting	Options	Description
<b>Keystone</b>	Varying levels available	Adjusts image shape to rectangular (vertically)
<b>Picture in Picture</b>	See the list of available Picture in Picture options	Adjusts the size and location of the sub-screen, swaps sources and exits Picture in Picture mode

Setting	Options	Description
<b>HDMI Link</b>	<b>Device Connections</b> <b>HDMI Link</b> <b>Audio Out Device</b> (PowerLite Home Cinema 5040UBe) <b>Power On Link</b> <b>Power Off Link</b> <b>Link Buffer</b>	Adjusts the HDMI Link options <b>Device Connections:</b> lists the devices connected to the <b>HDMI1</b> and <b>HDMI2</b> ports <b>HDMI Link:</b> enables or disables the HDMI Link function <b>Audio Out Device:</b> selects which port on the WirelessHD Transmitter outputs audio <b>Power On Link:</b> controls what happens when you turn on the projector or a linked device <ul style="list-style-type: none"> <li>• <b>PJ -&gt; Device</b> or <b>Bidirectional:</b> turns on the linked device when the projector is turned on</li> <li>• <b>Device -&gt; PJ</b> or <b>Bidirectional:</b> turns on the projector when the linked device is turned on</li> </ul> <b>Power Off Link:</b> controls whether linked devices are turned off when the projector is turned off <b>Link Buffer:</b> improves weak HDMI Link connections
<b>WirelessHD</b> (PowerLite Home Cinema 5040UBe)	<b>Connected Device</b> <b>WirelessHD</b> <b>Video Reception</b> <b>Reset</b>	Adjusts settings for use with the WirelessHD transmitter <b>Connected Device:</b> displays a list of available WirelessHD devices <b>WirelessHD:</b> controls whether the projector receives WirelessHD signals <b>Video Reception:</b> displays the strength of the WirelessHD signal <b>Reset:</b> resets the <b>WirelessHD</b> settings to their defaults.

Setting	Options	Description
<b>Lock Setting</b>	<b>Lens Lock</b> <b>Child Lock</b> <b>Control Panel Lock</b>	Controls projector lens and control panel button locking to secure the projector  <b>Lens Lock:</b> locks the focus, zoom, and lens shift settings <b>Child Lock:</b> locks the power button <b>Control Panel Lock:</b> <ul style="list-style-type: none"> <li>• <b>Full Lock:</b> locks all buttons</li> <li>• <b>Partial Lock:</b> locks all buttons except the power button</li> <li>• <b>Off:</b> no buttons locked</li> </ul>
<b>User Button</b>	<b>Fine/Fast</b> <b>3D Display</b> <b>2D-to-3D Conversion</b> <b>Power Consumption</b> <b>Info</b> <b>Display the QR Code</b>	Assigns a menu option to the <b>User</b> button on the remote control for one-touch access

Setting	Options	Description
<b>Memory</b>	<b>Load Memory</b> <b>Save Memory</b> <b>Erase Memory</b> <b>Rename Memory</b> <b>Load Lens Position</b> <b>Save Lens Position</b> <b>Erase Lens Position</b> <b>Rename Lens Position</b>	<p>Controls the saved projector settings and lens positions</p> <p><b>Load Memory:</b> displays the list of customized settings entries that you have created</p> <p><b>Save Memory:</b> saves the current projector settings to the projector's memory</p> <p><b>Erase Memory:</b> erases a saved memory position</p> <p><b>Rename Memory:</b> changes the name of a saved memory position</p> <p><b>Load Lens Position:</b> loads lens adjustment values saved with the <b>Save Lens Position</b> setting</p> <p><b>Save Lens Position:</b> saves the focus, zoom, and lens shift adjustments as a lens position entry</p> <p><b>Erase Lens Position:</b> deletes the saved lens position entry</p> <p><b>Rename Lens Position:</b> renames a saved lens position entry</p>

**Note:** The WirelessHD **Reset** option does not reset the settings on the WirelessHD Transmitter. To reset the transmitter settings, press the **Setup** button on the WirelessHD Transmitter for five seconds.

**Parent topic:** [Adjusting the Menu Settings](#)



## Projector Setup Settings - Extended Menu

Settings on the Extended menu let you customize various projector setup features that control its operation.

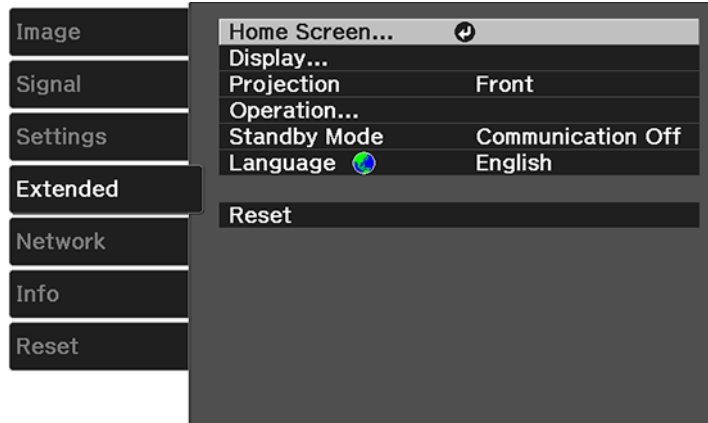

Setting	Options	Description
Home Screen	Home Screen Auto Disp. Custom Function 1 Custom Function 2	Adjust settings on the Home Screen  <b>Home Screen Auto Disp.:</b> controls whether the Home screen displays automatically when the projector is turned on  <b>Custom Function 1 / Custom Function 2:</b> let you customize the options displayed on the Home screen and save your settings as a preset
Display	—	See the <b>Display</b> settings table in this topic

Setting	Options	Description
<b>Projection</b>	<b>Front</b> <b>Front/Ceiling</b> <b>Rear</b> <b>Rear/Ceiling</b>	Selects the way the projector faces the screen so the image is oriented correctly
<b>Operation</b>	—	See the <b>Operation</b> settings table in this topic
<b>Standby Mode</b>	<b>Communication Off</b> <b>Communication On</b>	Indicates whether the projector can be monitored over a network while in standby mode
<b>Language</b>	Various languages available	Selects the language for projector menu and message displays (not changed by <b>Reset</b> option)

#### Display settings

Setting	Description
<b>Menu Position</b>	Selects the position of the projector menu displayed on the screen
<b>Messages</b>	Controls whether messages are displayed on the screen
<b>Display Background</b>	Selects the screen color or logo to display when no signal is received
<b>Startup Screen</b>	Controls whether a special screen appears when the projector starts up
<b>Standby Confirmation</b>	Displays a confirmation message after pressing the <b>Standby</b> button on the remote control
<b>Panel Alignment</b>	Corrects color misalignment in the projected image
<b>Color Uniformity</b>	Adjusts the color tone balance

#### Operation settings

Setting	Description
<b>Direct Power On</b>	Turns on the projector when you plug it in
<b>Sleep Mode</b>	Automatically places the projector in standby mode after an interval of inactivity
<b>Sleep Mode Timer</b>	Sets the time before the projector automatically turns off (Sleep Mode must be turned on)
<b>Illumination</b>	Turns off the lights on the projector
<b>Trigger Out</b>	Outputs a DC 12V signal from the 3.5 mm mini-jack <b>Trigger Out</b> port whenever the projector is turned on
<b>High Altitude Mode</b>	Regulates the projector's operating temperature at altitudes above 4921 feet (1500 m)

**Note:** The **Reset** setting does not reset the **Memory, Projection, High Altitude Mode, Standby Mode** or **Language** settings.

**Parent topic:** [Adjusting the Menu Settings](#)

**Related concepts**

[Projection Modes](#)

**Related references**

[Available Image Aspect Ratios](#)

**Related tasks**

[Using the Home Screen](#)

[Selecting External Network Detection Settings](#)

[Using Picture in Picture](#)

[Adjusting the Color Convergence \(Panel Alignment\)](#)

[Connecting to a Trigger Out Port](#)

## Projector Network Settings - Network Menu

Settings on the Network menu let you view network information and set up the projector for monitoring and control over a network.

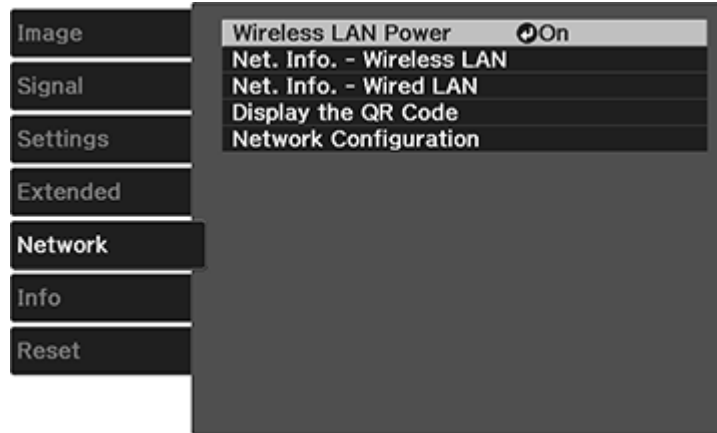

Setting	Options	Description
<b>Wireless LAN Power</b>	On Off	Enable or disable wireless communication
<b>Net. Info - Wireless LAN</b>	Connection mode Wireless LAN Sys. Antenna level Projector Name SSID DHCP IP Address Subnet Mask Gateway Address MAC Address Region Code	Displays wireless network status and details

Setting	Options	Description
Net. Info - Wired LAN	Projector Name DHCP IP Address Subnet Mask Gateway Address MAC Address	Displays wired network status and details
Display the QR Code	—	Displays the QR Code
Network Configuration	Accesses additional network menus	Configures your network settings

Parent topic: [Adjusting the Menu Settings](#)

## Projector Information Display - Info Menu

You can display information about the projector and input sources by viewing the Info menu. However, you cannot change any settings in the menu.

**Note:** To view the firmware version of the projector or other components, select **Version**.

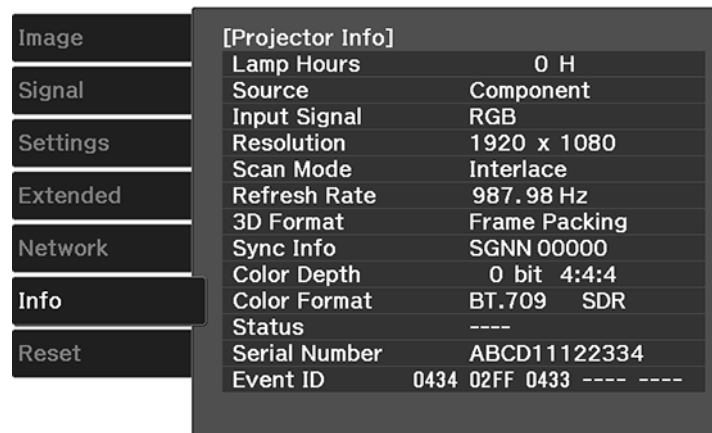

**Note:** Available settings depend on the current input source. The lamp usage timer does not register any hours until you have used the lamp for at least 10 hours.

**Projector Info** information

Information item	Description
<b>Lamp Hours</b>	Displays the number of hours ( <b>H</b> ) the lamp has been used
<b>Source</b>	Displays the name of the port to which the current input source is connected
<b>Input Signal</b>	Displays the input signal setting of the current input source
<b>Resolution</b>	Displays the resolution of the current input source
<b>Scan Mode</b>	Displays the scan mode of the current input source
<b>Refresh Rate</b>	Displays the refresh rate of the current input source
<b>3D Format</b>	Displays the format of the 3D signal
<b>Sync Info</b>	Displays information that may be needed by a service technician
<b>Color Depth</b>	Displays the color depth and color difference
<b>Color Format</b>	Displays information about the color space and dynamic range
<b>Status</b>	Displays information about projector problems that may be needed by a service technician
<b>Serial Number</b>	Displays the projector's serial number
<b>Event ID</b>	Displays the Event ID number corresponding to a specific projector problem; see the list of Event ID codes

[Event ID Code List](#)

**Parent topic:** [Adjusting the Menu Settings](#)

**Related tasks**

[Replacing the Lamp](#)

[Resetting the Lamp Timer](#)

**Event ID Code List**

If the **Event ID** option on the Info menu displays a code number, check this list of Event ID codes for the solution to the projector problem associated with the code.

Event ID code	Cause and solution	
0022	Unstable network communication. Check the network communication status, wait a few moments, and try connecting to the network again.	
0027		
0028		
0029		
0030		
0031		
0035		
0434		
0482		
0484		
0485		
0432		Turn the projector off and then on again.
0435		
0433	Cannot display the transferred images. Restart the network software.	
0484	Communication with computer was disconnected. Restart the network software.	
04FE	The network software quit unexpectedly. Check the network communication status, then turn the projector off and then on again.	
0479	A projector system error has occurred. Turn the projector off and then on again.	
04FF		
0891	Cannot find an access point with the same SSID. Set your computer, access point, and projector to the same SSID.	
0892	The WPA/WPA2 authentication type does not match. Make sure the wireless network security settings are correct.	
0894	Communication with unauthorized access point was disconnected. Contact your network administrator.	
0898	Failed to acquire DHCP. Make sure the DHCP server is operating correctly. If you are not using DHCP, turn off the <b>DHCP</b> setting in the Network menus.	

Event ID code	Cause and solution
0020	Communication error. Turn the projector off and then on again.
0026	
0032	
0036	
0037	
0038	
0899	

Parent topic: [Projector Information Display - Info Menu](#)

## Projector Reset Options - Reset Menu

You can reset most of the projector settings to their default values using the **Reset All Config** option on the Reset menu.

You can reset the projector's lamp usage timer to zero when you replace the lamp using the **Reset Lamp Hours** option, reset the lens position entries using the **Reset Lens Position** option, and reset all memory entries using the **Reset Memory** option.





You cannot reset the following settings using the **Reset All Config** option:

- Language
- Lamp Hours
- Memory settings
- All settings in the Network menu
- Panel Alignment
- Color Uniformity

**Parent topic:** [Adjusting the Menu Settings](#)

---

# Maintaining and Transporting the Projector

Follow the instructions in these sections to maintain your projector and transport it from place to place.

[Projector Maintenance](#)

[Transporting the Projector](#)

## Projector Maintenance

Your projector needs little maintenance to keep working at its best.

You may need to clean the lens periodically, and clean the air filter and air vents to prevent the projector from overheating due to blocked ventilation.

The only parts you should replace are the lamp, air filter, and remote control batteries. If any other part needs replacing, contact Epson or an authorized Epson servicer.

**Warning:** Before cleaning any part of the projector, turn it off and unplug the power cord. Never open any cover on the projector, except as specifically explained in this manual. Dangerous electrical voltages in the projector can injure you severely.

**Warning:** Do not try to service this product yourself, except as specifically explained in this manual. Refer all other servicing to qualified servicers.

[Cleaning the Lens](#)

[Cleaning the Projector Case](#)

[Cleaning the 3D Glasses](#)

[Air Filter and Vent Maintenance](#)

[Projector Lamp Maintenance](#)

[Replacing the Remote Control Batteries](#)

**Parent topic:** [Maintaining and Transporting the Projector](#)

## Cleaning the Lens

Clean the projector's lens periodically, or whenever you notice dust or smudges on the surface.

**Note:** If the projector has been in use, wait 30 minutes before cleaning the lens.

- To remove dust or smudges, gently move the shutter to the side and wipe the lens with lens-cleaning paper. After cleaning, close the shutter.
- To remove stubborn smudges, moisten a soft, lint-free cloth with lens cleaner and gently wipe the lens. Do not spray any liquid directly on the lens.

**Warning:** Do not use a lens cleaner that contains flammable gas. The high heat generated by the projector lamp may cause a fire.

**Caution:** Do not use glass cleaner or any harsh materials to clean the lens and do not subject the lens to any impacts; you may damage it. Do not use canned air, or the gases may leave a residue. Avoid touching the lens with your bare hands to prevent fingerprints on or damage to the lens surface.

**Parent topic:** [Projector Maintenance](#)

## Cleaning the Projector Case

Before cleaning the projector case, turn off the projector and unplug the power cord.

**Note:** If the projector has been in use, wait 30 minutes before cleaning it.

- To remove dust or dirt, use a soft, dry, lint-free cloth.
- To remove stubborn dirt, use a soft cloth moistened with water and mild soap. Do not spray liquid directly on the projector.

**Caution:** Do not use wax, alcohol, benzene, paint thinner, or other chemicals to clean the projector case. These can damage the case. Do not use canned air, or the gases may leave a residue.

**Parent topic:** [Projector Maintenance](#)

## Cleaning the 3D Glasses

To remove dust, dirt, smudges, or fingerprints from the glasses, use a soft, dry, lint-free cloth.

**Note:** Unplug any charging cables from the glasses before cleaning them.

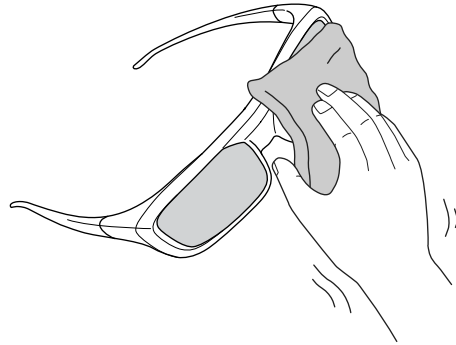

**Caution:** Do not use paper towels or any other abrasive materials to clean the glasses.

**Parent topic:** [Projector Maintenance](#)

## **Air Filter and Vent Maintenance**

Regular filter maintenance is important to maintaining your projector. Your Epson projector is designed with an easily accessible, user-replaceable filter to protect your projector and make regular maintenance simple. Filter maintenance intervals will depend on the environment.

If regular maintenance is not performed, your Epson projector will notify you when the temperature inside the projector has reached a high level. Do not wait until this warning appears to maintain your projector filter as prolonged exposure to high temperatures may reduce the life of your projector or lamp.

Damage due to the failure to properly maintain the projector or its filter may not be covered by the projector or lamp Limited Warranties.

[Cleaning the Air Filter](#)

[Replacing the Air Filter](#)

**Parent topic:** [Projector Maintenance](#)

**Related references**

[Projector Light Status](#)

### **Cleaning the Air Filter**

You need to clean the projector's air filter in the following situations:

- The filter or vents get dusty.

- You see a message telling you to clean it.
1. Turn off the projector and unplug the power cord.
  2. Press and hold the tab on the air filter cover, and pull to remove the cover.

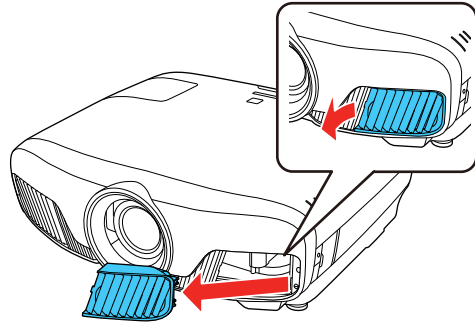

3. Pull the air filter out of the projector.

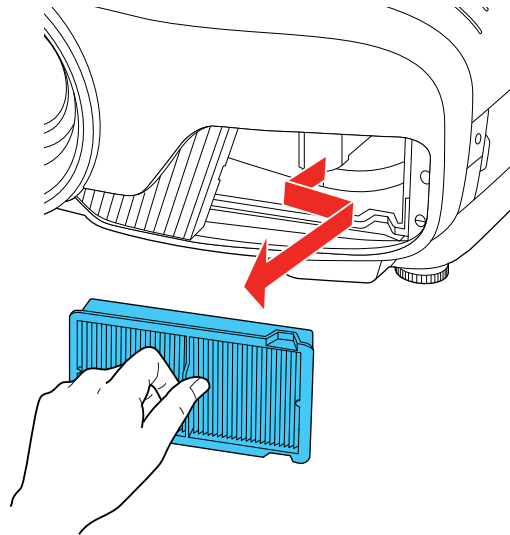

4. Tap each side of the air filter 4 to 5 times to shake off any excess dust. Do this outside the room or away from the projector.

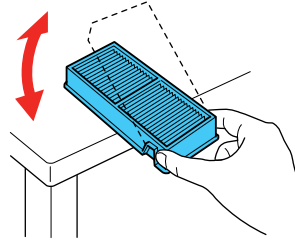

**Caution:** Do not use excessive force when tapping the air filter, or it may crack and become unusable. Do not rinse the air filter in water, or use any detergent or solvent to clean it. Do not use canned air; the gases may leave a residue, or push dust and debris into the projector's optics or other sensitive areas.

5. Vacuum the front of the air filter (the side with the tabs) to remove any remaining dust.

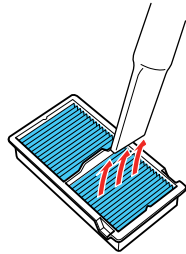

**Note:** If dust is difficult to remove or the air filter is damaged, replace the air filter.

6. Place the air filter back in the projector as shown.

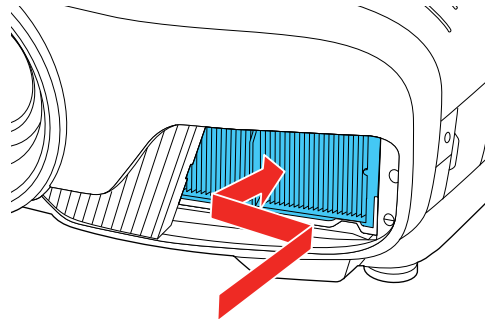

7. Attach the air filter cover as shown.

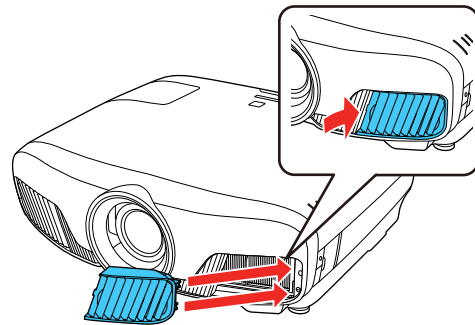

**Parent topic:** [Air Filter and Vent Maintenance](#)

**Related tasks**

[Replacing the Air Filter](#)

### Replacing the Air Filter

You need to replace the air filter in the following situations:

- After cleaning the air filter, you see a message telling you to clean or replace it
- The air filter is torn or damaged

You can replace the air filter while the projector is mounted to the ceiling or placed on a table.

1. Turn off the projector and unplug the power cord.

2. Press and hold the tab on the air filter cover, and pull to remove the cover.

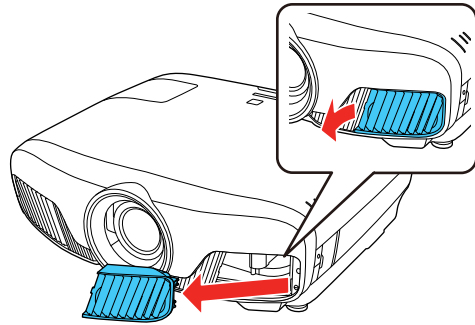

3. Pull the air filter out of the projector.

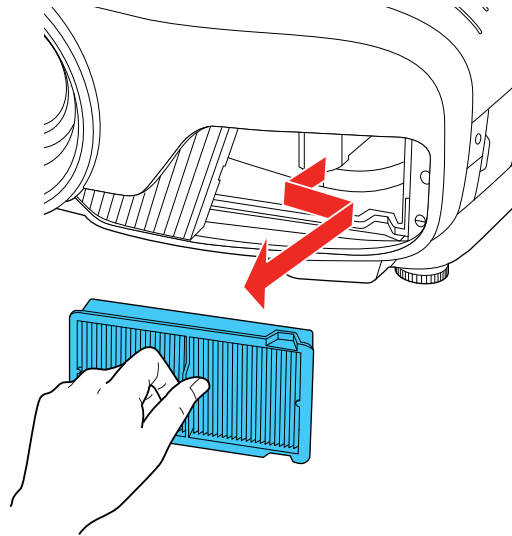

**Note:** Air filters contain polypropylene. Dispose of used air filters according to local regulations.



4. Place the new air filter in the projector as shown.

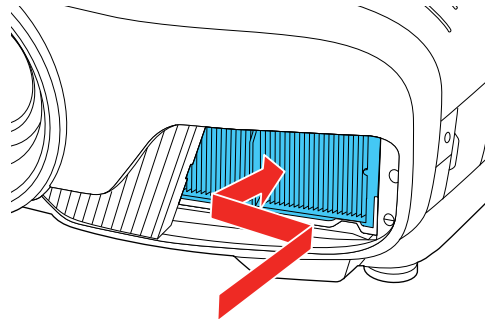

5. Attach the air filter cover as shown.

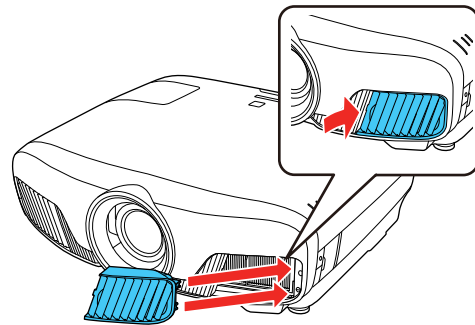

Parent topic: [Air Filter and Vent Maintenance](#)

## Projector Lamp Maintenance

The projector keeps track of the number of hours the lamp is used and displays this information in the projector's menu system.

Replace the lamp as soon as possible when the following occurs:

- The projected image gets darker or starts to deteriorate
- A message appears when you turn on the projector telling you to replace the lamp

[Replacing the Lamp](#)

[Resetting the Lamp Timer](#)

**Parent topic:** [Projector Maintenance](#)

**Related references**

[Projector Information Display - Info Menu](#)

[Optional Equipment and Replacement Parts](#)

[Projector Lamp Specifications](#)

**Replacing the Lamp**

Before you replace the lamp, let the projector cool down for at least one hour so the lamp will not be hot.

**Warning:** Let the lamp fully cool before replacing it to avoid injury.

You can replace the lamp while the projector is mounted to the ceiling, if necessary.

1. Turn off the projector and unplug the power cord.
2. Allow the projector lamp to cool down for at least one hour.
3. Use the screwdriver included with the replacement lamp to loosen the screw securing the lamp cover.

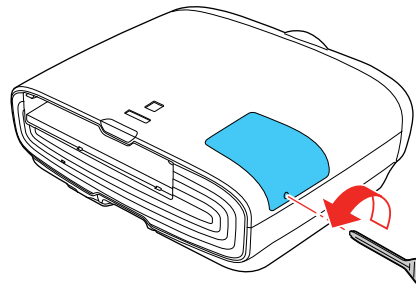

**Warning:** If the lamp is broken, glass fragments may be loose inside the lamp chamber. Be careful removing any broken glass to avoid injury. If the projector is installed on the ceiling, stand to the side of the lamp cover and not underneath it; pieces of glass could fall into your eyes or mouth when you open the lamp cover.

4. Slide the lamp cover out and lift it off.

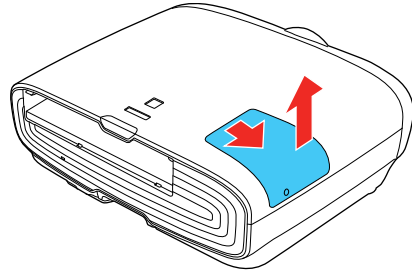

5. Loosen the screws securing the lamp to the projector. The screws do not come all the way out.

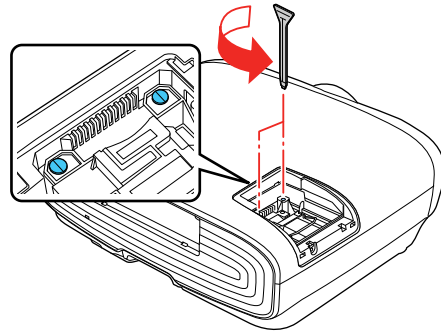

6. Lift up the lamp handle and gently pull the lamp out of the projector.

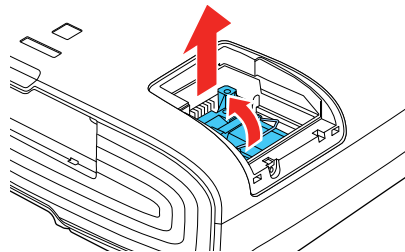

**Note:** (Hg) The lamp(s) in this product contain mercury. Please consult your state and local regulations regarding disposal or recycling. Do not put in the trash.

7. Gently insert the new lamp into the projector. If it does not fit easily, make sure it is facing the right way. Lower the handle.

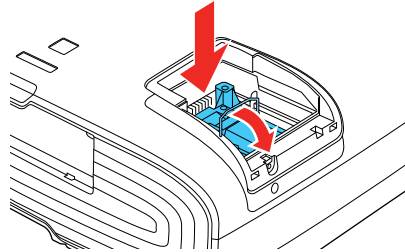

**Caution:** Do not touch any glass on the lamp assembly to avoid premature lamp failure.

8. Push in the lamp firmly and tighten the screws to secure it.

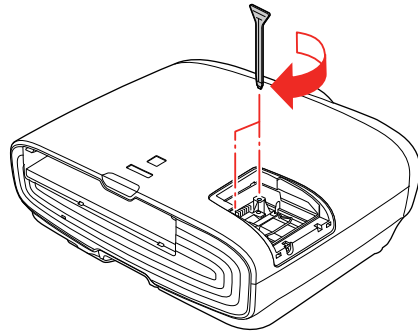

**Caution:** Do not over-tighten the screws.

9. Replace the lamp cover and tighten the screw to secure it.

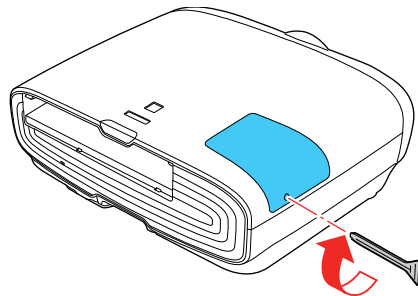
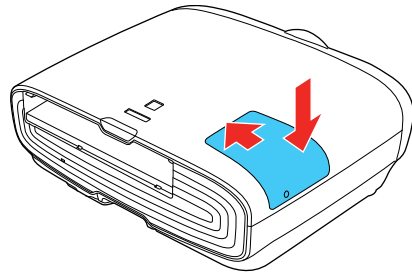

**Note:** Be sure the lamp cover is securely installed or the lamp will not come on.

Reset the lamp timer to zero to keep track of the new lamp's usage.

**Parent topic:** [Projector Lamp Maintenance](#)

**Related tasks**

[Resetting the Lamp Timer](#)

**Resetting the Lamp Timer**

You must reset the lamp timer after replacing the projector's lamp to clear the lamp replacement message and to keep track of lamp usage correctly.

**Note:** Do not reset the lamp timer if you have not replaced the lamp to avoid inaccurate lamp usage information.

1. Turn on the projector.

2. Press the **Menu** button.
3. Select the **Reset** menu and press **Enter**.

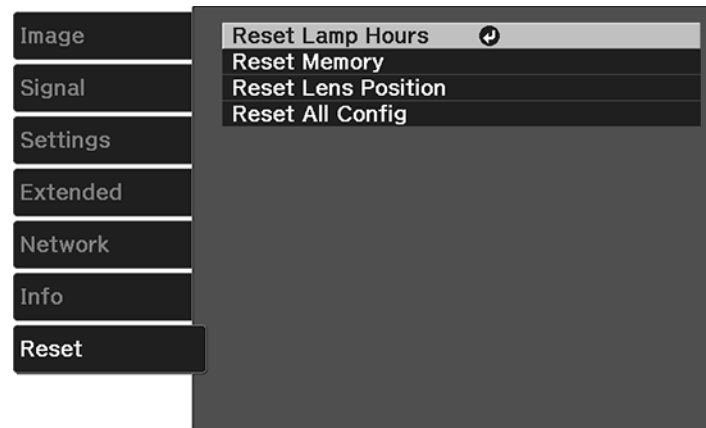

4. Select **Reset Lamp Hours** and press **Enter**.  
You see a prompt asking if you want to reset the lamp hours.
5. Select **Yes** and press **Enter**.
6. Press **Menu** or **Esc** to exit the menus.

**Parent topic:** [Projector Lamp Maintenance](#)

## Replacing the Remote Control Batteries

The remote control uses two AA manganese or alkaline batteries. Replace the batteries as soon as they run out.

**Caution:** Use only the type of batteries specified in this manual. Do not install batteries of different types, or mix new and old batteries.

1. Remove the battery cover as shown.

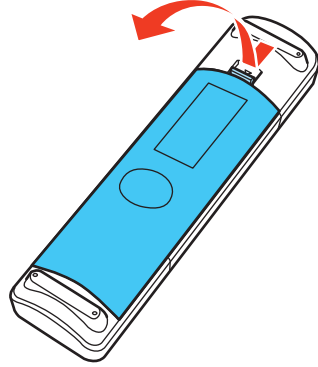

2. Remove the old batteries.

**Warning:** If the battery fluid has leaked, wipe it away with a soft cloth and avoid getting the fluid on your hands. If it gets on your hands, wash them immediately to avoid injury.

3. Insert the batteries with the + and – ends facing as shown.

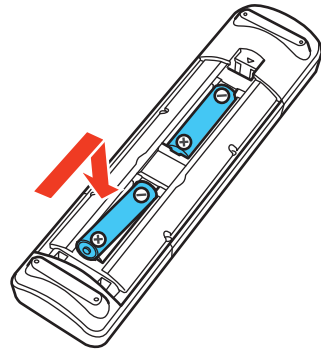

4. Replace the battery cover and press it down until it clicks into place.

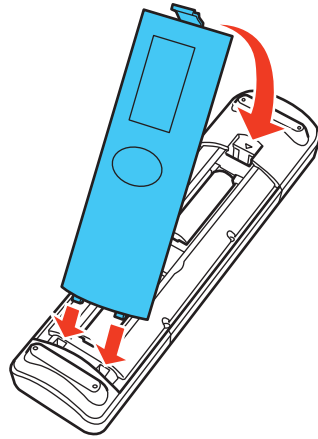

**Warning:** Dispose of used batteries according to local regulations. Do not expose batteries to heat or flame. Keep batteries out of the reach of children; they are choking hazards and are very dangerous if swallowed.

**Parent topic:** [Projector Maintenance](#)

**Related references**

[Remote Control Specifications](#)

## Transporting the Projector

The projector contains precision parts, some of which are glass. Follow these guidelines to transport, ship, or store the projector safely:

- Remove any equipment connected to the projector.
- Center the lens position using the **Lens** button.
- When transporting the projector a long distance or as checked luggage, pack it in a firm box with cushioning around it and mark the box "Fragile."
- When shipping the projector for repairs, place it in its original packing materials, if possible, or use equivalent materials with cushioning around the projector. Mark the box "Fragile."

**Note:** Epson shall not be liable for any damages incurred during transportation.



**Parent topic:** [Maintaining and Transporting the Projector](#)

**Related tasks**

[Turning Off the Projector](#)

---

# Solving Problems

Check the solutions in these sections if you have any problems using the projector.

[Projection Problem Tips](#)

[Projector Light Status](#)

[Solving Image Problems](#)

[Solving Projector or Remote Control Operation Problems](#)

[Solutions When Wireless Authentication Fails](#)

[Where to Get Help](#)

## Projection Problem Tips

If the projector is not working properly, try turning it off and unplugging it. Then plug it back in and turn it on.

If this does not solve the problem, check the following:

- The lights on the projector may indicate what the problem is.
- The solutions in this manual can help you solve many problems.

If none of these solutions help, you can contact Epson for technical support.

**Parent topic:** [Solving Problems](#)

## Projector Light Status

The lights on the projector indicate the projector status and let you know when a problem occurs. Check the status and color of the lights and look for a solution in the table here.

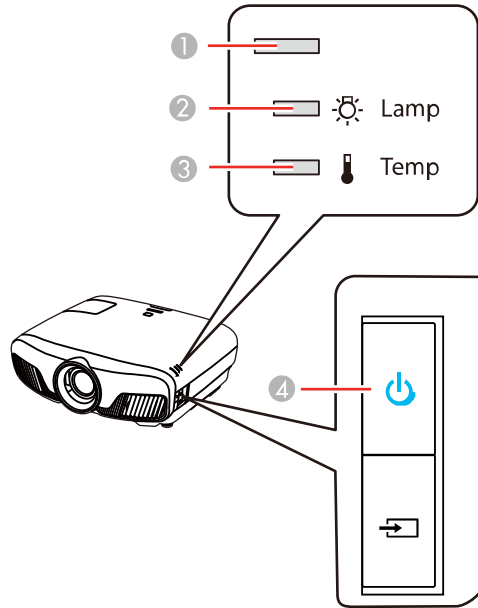

- 1 Status light
- 2 Lamp light
- 3 Temp light
- 4 Power light

Power light	Status light	Lamp light	Temp light	Status and solution
Blue	Blue	Off	Off	Normal operation

Power light	Status light	Lamp light	Temp light	Status and solution
Blue	Flashing blue	Off	Off	Warming up; wait for an image to appear
				Shutting down; when the status light stops flashing, you can unplug the projector
Off	Off	Off	Off	Standby or sleep mode
Blue	Varies	Off	Flashing orange	<p>Projector is too hot</p> <ul style="list-style-type: none"> <li>• Make sure that the vents and air filter are not clogged with dust or obstructed by nearby objects</li> <li>• Clean or replace the air filter</li> <li>• Make sure the environmental temperature is not too hot</li> </ul>
Off	Flashing blue	Off	Orange	<p>Projector has overheated and turned off; leave it turned off to cool down for about five minutes, then do the following:</p> <ul style="list-style-type: none"> <li>• Make sure that the vents and air filter are not clogged with dust or obstructed by nearby objects</li> <li>• Clean or replace the air filter</li> <li>• If operating the projector at high altitude, turn on <b>High Altitude Mode</b></li> <li>• If the problem persists, unplug the projector and contact Epson for help</li> </ul>

Power light	Status light	Lamp light	Temp light	Status and solution
Off	Flashing blue	Orange	Off	Lamp has a problem <ul style="list-style-type: none"> <li>• Check the Lamp Hours in the <b>Info</b> menu to see if the lamp is burned out. Unplug the projector, wait for the lamp to cool down, and check if it is broken or installed incorrectly; reseal or replace the lamp as necessary</li> <li>• Clean or replace the air filter</li> <li>• Make sure the lamp cover is closed</li> <li>• If operating the projector at high altitude, turn on <b>High Altitude Mode</b></li> <li>• If the problem persists, unplug the projector and contact Epson for help</li> </ul>
Blue	Varies	Flashing orange	Off	Replace the lamp soon to avoid damage; do not continue using the projector
Off	Flashing blue	Off	Flashing orange	A fan or sensor has a problem; turn the projector off, unplug it, and contact Epson for help
Off	Flashing blue	Flashing orange	Flashing orange	Auto Iris or Cinema Filter error; turn the projector off, unplug it, and contact Epson for help
Off	Flashing blue	Orange	Orange	Power error; turn the projector off, unplug it, and contact Epson for help
Off	Flashing blue	Flashing orange	Off	Internal projector error; turn the projector off, unplug it, and contact Epson for help

**Note:** If the lights display a pattern not listed in the table above, turn the projector off, unplug it, and contact Epson for help.

**Parent topic:** [Solving Problems](#)

**Related references**

[Projector Setup Settings - Extended Menu](#)

**Related tasks**

[Cleaning the Air Filter](#)

[Replacing the Lamp](#)

[Replacing the Air Filter](#)

## Solving Image Problems

Check the solutions in these sections if you have any problems with projected images.

[Solutions When No Image Appears](#)

[Solutions When "No Signal" Message Appears](#)

[Solutions When "Not Supported" Message Appears](#)

[Solutions When Only a Partial Image Appears](#)

[Solutions When the Image is Not Rectangular](#)

[Solutions When the Image Contains Noise or Static](#)

[Solutions When the Image is Fuzzy or Blurry](#)

[Solutions When the Image Brightness or Colors are Incorrect](#)

[Solutions When a 3D Image Does Not Display Correctly](#)

[Solutions When a WirelessHD Source Does Not Display Correctly](#)

**Parent topic:** [Solving Problems](#)

### Solutions When No Image Appears

If no image appears, try the following solutions:

- Make sure the lens cover is open all the way.
- Press the **Blank** button on the remote control to see if the image was temporarily turned off.
- Make sure all necessary cables are securely connected and the power is on for the projector and connected video sources.
- Press the projector's power button to wake it from standby or sleep mode. Also see if your connected computer is in sleep mode or displaying a blank screen saver.
- Press the **Menu** button. If the projector menu is able to display, there may be a problem with the connected video source, cable connection, or port.

- Check the settings on the Signal menu to make sure they are correct for the current video source.
- Adjust the **Brightness** setting or select the **Normal** Power Consumption setting.
- Check the **Display** setting to make sure **Messages** is set to **On**.
- If the projector does not respond when you press the control panel buttons, the buttons may be locked. Unlock the buttons.
- For images projected with Windows Media Center, reduce the screen size from full screen mode.
- For images projected from applications using Windows DirectX, turn off DirectX functions.
- If the other solutions do not solve the problem, reset all of the projector settings using the options on the **Reset** menu.

**Parent topic:** [Solving Image Problems](#)

**Related references**

[Image Quality Settings - Image Menu](#)

[Projector Setup Settings - Extended Menu](#)

**Related tasks**

[Unlocking the Projector's Buttons](#)

## Solutions When "No Signal" Message Appears

If the "No Signal" message appears, try the following solutions:

- Press the source button on the projector repeatedly to cycle through the available sources. Wait a few seconds for an image to appear.
- Press a source button on the remote to select an available source. Wait a few seconds for an image to appear.
- Press the **Home** button on the remote control to select from a list of available sources (shown in black text).
- Turn on the connected computer or video source, and press its play button to begin your presentation, if necessary.
- Check the connection from the projector to your video sources.
- If you are projecting from a laptop computer, make sure it is set up to display on an external monitor.
- If necessary, turn the projector and the connected computer or video source off and then on again.
- If the other solutions do not solve the problem, reset all of the projector settings using the options on the **Reset** menu.

[Displaying From a PC Laptop](#)

[Displaying From a Mac Laptop](#)

**Parent topic:** [Solving Image Problems](#)

**Related concepts**

[Projector Connections](#)

### Displaying From a PC Laptop

If you see the "No Signal" message when you display from a PC laptop, you need to set up the laptop to display on an external monitor.

1. Hold down the laptop's **Fn** key and press the key labeled with a monitor icon or **CRT/LCD**. (See your laptop manual for details.) Wait a few seconds for an image to appear.
2. To display on both the laptop's monitor and the projector, try pressing the same keys again.
3. If the same image is not displayed by the laptop and projector, check the Windows **Display** utility to make sure the external monitor port is enabled and extended desktop mode is disabled. (See your computer or Windows manual for instructions.)
4. If necessary, check your video card settings and set the multiple display option to **Mirror** or **Duplicate**.

**Parent topic:** [Solutions When "No Signal" Message Appears](#)

### Displaying From a Mac Laptop

If you see the "No Signal" message when you display from a Mac laptop, you need to set up the laptop for mirrored display. (See your laptop manual for details.)

1. Open the **System Preferences** utility and select **Displays**.
2. Click the **Arrangement** tab.
3. Select the **Mirror Displays** checkbox.

**Parent topic:** [Solutions When "No Signal" Message Appears](#)

### Solutions When "Not Supported" Message Appears

If the "Not Supported" message appears, try the following solutions:

- Make sure the computer's display resolution does not exceed the projector's resolution and frequency limit. If necessary, select a different display resolution for your computer. (See your computer manual for details.)
- As a test, try setting the computer's display resolution to the lowest possible setting, and then gradually increase it as necessary.



- Check the input resolution under **Projector Info** in the **Info** menu and make sure that the projector supports that resolution.

**Parent topic:** [Solving Image Problems](#)

**Related references**

[Input Signal Settings - Signal Menu](#)

[Projector Setup Settings - Extended Menu](#)

[Supported Video Display Formats](#)

[Input Signal Settings - Signal Menu](#)

[Projector Setup Settings - Extended Menu](#)

[Supported Video Display Formats](#)

## Solutions When Only a Partial Image Appears

If only a partial computer image appears, try the following solutions:

- Try adjusting the image position using the **Position** menu setting.
- Try adjusting the image position using the **Lens** button on the remote control or control panel.
- Press the **Aspect** button on the remote control to select a different image aspect ratio.
- Select a different image aspect ratio in the Signal menu.
- Check the cables connecting the computer or video source to the projector. Try connecting different cables.
- Check your computer display settings to disable dual display and set the resolution within the projector's limits. (See your computer manual for details.)
- Check the resolution assigned to your presentation files to see if they are created for a different resolution than you are projecting in. (See your software help for details.)

**Parent topic:** [Solving Image Problems](#)

**Related references**

[Input Signal Settings - Signal Menu](#)

[Supported Video Display Formats](#)

## Solutions When the Image is Not Rectangular

If the projected image is not evenly rectangular, try the following solutions:

- Place the projector directly in front of the center of the screen, facing it squarely, if possible.
- Try to fix the image using lens shift before adjusting the **Keystone** setting.

- If you adjusted the projector height using the projector feet, press the keystone buttons on the projector to adjust the image shape.
- Adjust the image shape using the **Keystone** menu setting.

**Parent topic:** [Solving Image Problems](#)

**Related references**

[Projector Feature Settings - Settings Menu](#)

**Related tasks**

[Correcting Image Shape With the Keystone Buttons](#)

## Solutions When the Image Contains Noise or Static

If the projected image seems to contain electronic interference (noise) or static, try the following solutions:

- Check the cables connecting your computer or video source to the projector. They should be:
  - Separated from the power cord to prevent interference
  - Securely connected at both ends
  - Not connected to an extension cable
  - No longer than 10 feet (3 m) for VGA/computer cables or 24 feet (7.3 m) for HDMI cables
- Check the settings on the projector's Signal menu to make sure they match the video source. If available for your video source, adjust the **Deinterlacing** and **Noise Reduction** settings.
- Select a computer video resolution and refresh rate that are compatible with the projector.
- If you are projecting from a computer, display a uniformly patterned image on the screen and manually adjust the **Tracking** and **Sync** settings.
- If you adjusted the image shape using the projector controls, try decreasing the **Sharpness** setting to improve image quality.
- If you connected an extension power cable, try projecting without it to see if it caused interference in the signal.
- Try turning off **Frame Interpolation**, or turn on **Image Enhancement** in the Image menu.

**Parent topic:** [Solving Image Problems](#)

**Related references**

[Image Quality Settings - Image Menu](#)

[Input Signal Settings - Signal Menu](#)

## Solutions When the Image is Fuzzy or Blurry

If the projected image is fuzzy or blurry, try the following solutions:

- Adjust the image focus.
- Clean the projector lens.
- Check the lens for condensation.

**Note:** To avoid condensation on the lens after bringing the projector in from a cold environment, let the projector warm up to room temperature before using it.

- Position the projector close enough to the screen, and directly in front of it.
- Position the projector so the keystone adjustment angle is not so wide that it distorts the image.
- Adjust the **Sharpness** setting to improve image quality.
- If you are projecting from a computer, display a uniformly patterned image on the screen and adjust the **Tracking** and **Sync** settings.
- If you are projecting from a computer, use a lower resolution.
- Check the resolution of your video source. If you are projecting from a standard definition video source, your image will not be as clear as an HD (720p/1080i/1080p) video source.

**Parent topic:** [Solving Image Problems](#)

### Related references

[Image Quality Settings - Image Menu](#)

[Projection Distance](#)

### Related tasks

[Focusing the Image with the Lens Button](#)

[Cleaning the Lens](#)

## Solutions When the Image Brightness or Colors are Incorrect

If the projected image is too dark or light, or the colors are incorrect, try the following solutions:

- Press the **Color Mode** button on the remote control to try different color modes for the image and environment.
- Check your video source settings.

- Adjust the available settings on the Image menu for the current input source, such as **Brightness**, **Contrast**, **Tint**, **Advanced**, and **Color Saturation**.
- Turn off the HDR mode in the **Dynamic Range** setting or set the **Color Space** setting to **BT.709**.
- Make sure all the cables are securely connected to the projector and your video device. If you connected long cables, try connecting shorter cables.
- Position the projector close enough to the screen.
- If the image has been progressively darkening, you may need to replace the projector lamp soon.

**Parent topic:** [Solving Image Problems](#)

#### **Related references**

[Image Quality Settings - Image Menu](#)

[Projector Setup Settings - Extended Menu](#)

## **Solutions When a 3D Image Does Not Display Correctly**

If a 3D image does not display correctly, try the following solutions:

- Make sure the **3D Display** setting on the Signal menu is set to **Auto** or **3D**.
- Make sure your video device and media are both 3D-compatible. Refer to the documentation that came with your video device for more information.
- Make sure you are using an HDMI cable that supports 3D signals.
- Make sure you selected the correct **3D Format** setting on the Signal menu. Normally this should be set to **Auto**, but in some cases you may need to select a different setting to match the 3D signal from your video device.
- Make sure you are using RF 3D active shutter glasses. You can purchase them from Epson.
- Make sure your 3D glasses are turned on and fully charged. If the glasses have entered standby mode, slide the power switch on the glasses to the **Off** position and then back to the **On** position.
- Make sure your 3D glasses are paired with the projector.
- Adjust the **3D Depth** setting on the Signal menu.
- Make sure you are within the 3D viewing range.
- Make sure your screen size matches the **Diagonal Screen Size** setting on the Signal menu.
- Avoid using the projector near wireless networks, microwave ovens, 2.4 GHz cordless phones, or other devices that use the 2.4 GHz frequency band. These devices can interfere with the signal between the projector and the 3D glasses.

- If the other solutions do not solve the problem, change the **Inverse 3D Glasses** setting on the Signal menu. Return the setting to its original value if changing it does not solve the problem as it can adversely affect the 3D image.

**Parent topic:** [Solving Image Problems](#)

**Related references**

[Projector Feature Settings - Settings Menu](#)

[Optional Equipment and Replacement Parts](#)

[3D Viewing Range](#)

**Related tasks**

[Pairing the 3D Glasses with the Projector](#)

[Charging the 3D Glasses](#)

[Cleaning the 3D Glasses](#)

## Solutions When a WirelessHD Source Does Not Display Correctly

If a WirelessHD source does not display correctly, try the following solutions:

- Make sure WirelessHD is selected as the image source on the projector.
- Open the WirelessHD reception monitor in the Settings menu and check the strength of the WirelessHD signal. If the signal is weak, you may need to move the transmitter closer to the projector or remove any large objects located between the transmitter and the projector.
- Make sure that your projector is connected to the correct WirelessHD device. It can take up to 30 seconds for a signal to sync and appear after connecting.
- You may need to reset the WirelessHD connection. Turn off both the WirelessHD transmitter and the projector. Start playback on your video device, then turn on the WirelessHD transmitter and the projector. Wait 10 seconds, then press the **Setup** button on the bottom of the transmitter.
- Make sure the WirelessHD transmitter is within 32 feet (10 m) of the projector, isn't obstructed by any large objects, and is not placed on a metal surface.
- If you are viewing wireless content, make sure that the WiHD light on the transmitter is on. If it is off, press the **WiHD/Pass** button on the remote control or transmitter.
- Make sure the HDMI cable between the source and the WirelessHD transmitter conforms to HDMI standards.

**Parent topic:** [Solving Image Problems](#)

**Related references**

[WirelessHD Transmission Range](#)

[Projector Feature Settings - Settings Menu](#)

**Related tasks**

[Connecting the WirelessHD Transmitter](#)

[Switching WirelessHD Sources](#)

## **Solving Projector or Remote Control Operation Problems**

Check the solutions in these sections if you have problems operating the projector or remote control.

[Solutions to Projector Power or Shut-Off Problems](#)

[Solutions to Problems with the Remote Control](#)

[Solutions to Password Problems](#)

[Solutions to Panel Alignment Problems](#)

[Solutions When Using HDMI Link](#)

**Parent topic:** [Solving Problems](#)

### **Solutions to Projector Power or Shut-Off Problems**

If the projector does not come on when you press the power button or it shuts off unexpectedly, try the following solutions:

- Make sure the power cord is securely connected to the projector and to a working electrical outlet.
- The projector's buttons may be locked for security. Unlock the buttons or use the remote control to turn on the projector.
- If the projector's lamp shuts off unexpectedly, it may have entered standby mode after a period of inactivity. Press the power button to wake the projector and adjust the **Sleep Mode Timer** setting to change the sleep interval.
- If the projector's lamp shuts off, the status light is flashing blue, and the Temp light is orange, the projector has overheated and shut off. Check the solutions for this light status.
- If the power button on the remote control does not turn on the projector, check its batteries and make sure the **Remote Receiver** setting is turned on in the projector's menu, if available.
- The power cord may be defective. Try another power cord. If that doesn't work, disconnect the cord and contact Epson.
- Make sure the lamp and lamp cover are installed correctly.

**Parent topic:** [Solving Projector or Remote Control Operation Problems](#)

**Related references**

[Where to Get Help](#)

[Projector Light Status](#)

[Projector Feature Settings - Settings Menu](#)

**Related tasks**

[Replacing the Remote Control Batteries](#)

[Unlocking the Projector's Buttons](#)

## Solutions to Problems with the Remote Control

If the projector does not respond to remote control commands, try the following solutions:

- Check that the remote control batteries are installed correctly and have power. If necessary, replace the batteries.
- Make sure you are operating the remote control within the reception angle and range of the projector.
- Make sure the projector is not warming up or shutting down.
- Check to see if a button on the remote control is stuck down, causing it to enter sleep mode. Release the button to wake the remote control up.
- Strong fluorescent lighting, direct sunlight, or infrared device signals may be interfering with the projector's remote receivers. Dim the lights or move the projector away from the sun or interfering equipment.
- If available, turn off one of the remote receivers in the projector's menu system, or check if all the remote receivers were turned off.
- If you assigned an ID number to the remote control to operate multiple projectors, you may need to check or change the ID setting (feature not available with all projectors).
- If you lose the remote control, you can purchase another from an authorized Epson reseller.
- If you are using the WirelessHD buttons on the remote, make sure you point the remote at the WirelessHD transmitter.

**Parent topic:** [Solving Projector or Remote Control Operation Problems](#)

**Related references**

[Optional Equipment and Replacement Parts](#)

[Remote Control Operation](#)

[Projector Feature Settings - Settings Menu](#)

### Related tasks

[Replacing the Remote Control Batteries](#)

## Solutions to Password Problems

If you cannot enter or remember a password, try the following solutions:

- You may have turned on password protection without first setting a password. Try entering **0000** using the remote control.
- If you have entered an incorrect password too many times and see a message displaying a request code, write down the code and contact Epson. Do not attempt to enter the password again. Provide the request code and proof of ownership for assistance in unlocking the projector.
- If you lose the remote control, you cannot enter a password. Order a new one from Epson.

**Parent topic:** [Solving Projector or Remote Control Operation Problems](#)

### Related references

[Where to Get Help](#)

[Optional Equipment and Replacement Parts](#)

[Projector Feature Settings - Settings Menu](#)

## Solutions to Panel Alignment Problems

If the panel alignment does not result in a satisfactory picture, try the following solutions:

- Make sure the **Projection** setting matches the installation position.
- Make sure the projection surface is not colored or textured. Project on a white surface with no texture.
- Leave the projector on for 10 to 15 minutes before adjusting the panel alignment.
- The projected image size should be at least 60 inches (152 cm) during panel alignment.
- If the image contains too much magenta, adjust the red and blue panels.
- If the pattern lines look fuzzy or out of focus, adjust the focus before performing the panel alignment.

**Parent topic:** [Solving Projector or Remote Control Operation Problems](#)

### Related references

[Projection Distance](#)

### Related tasks

[Adjusting the Color Convergence \(Panel Alignment\)](#)

[Focusing the Image with the Lens Button](#)



## Solutions When Using HDMI Link

If you cannot control an HDMI device using the HDMI Link buttons, try the following solutions:

- Make sure all necessary cables are securely connected and the power is on for the projector and connected video sources.
- Make sure the cables meet the HDMI standards.
- Make sure the connected device supports the CEC standards.
- If you connected a new device or changed any connections, you may need to restart the device.
- Connect no more than three devices that support HDMI Link at the same time.
- If you have connected a speaker or receiver, set the output to PCM.

**Parent topic:** [Solving Projector or Remote Control Operation Problems](#)

## Solutions When Wireless Authentication Fails

If you cannot authenticate a wireless connection, try the following solutions:

- Make sure the **Wireless LAN Power** setting is set to **On**.
- Check the Security settings and passphrase in the Network Configuration menu.
- Check the Event ID number displayed in the Info menu and check the link below to identify the problem.

**Parent topic:** [Solving Problems](#)

### Related references

[Projector Feature Settings - Settings Menu](#)

[Projector Network Settings - Network Menu](#)

[Event ID Code List](#)

## Where to Get Help

If you need to contact Epson for technical support services, use the following support options.

### Internet Support

Visit Epson's support website at [epson.com/support](http://epson.com/support) (U.S.) or [epson.ca/support](http://epson.ca/support) (Canada) for solutions to common problems with your projector. You can download utilities and documentation, get FAQs and troubleshooting advice, or e-mail Epson with your questions.

### **Speak to a Support Representative**

To use the Epson PrivateLine Support service, call (800) 637-7661. This service is available for the duration of your warranty period. You may also speak with a projector support specialist by dialing (562) 276-4394 (U.S.) or (905) 709-3839 (Canada).

Support hours are 6 AM to 8 PM, Pacific Time, Monday through Friday and 7 AM to 4 PM, Pacific Time, Saturday.

Days and hours of support are subject to change without notice. Toll or long distance charges may apply.

Before you call, have the following information ready:

- Product name
- Product serial number (located on the bottom or rear of the projector, or in the menu system)
- Proof of purchase (such as a store receipt) and date of purchase
- Computer or video configuration
- Description of the problem

### **Purchase Supplies and Accessories**

You can purchase screens, other optional accessories, and replacement parts from an Epson authorized reseller. To find the nearest reseller, call 800-GO-EPSON (800-463-7766). Or you can purchase online at [epsonstore.com](http://epsonstore.com) (U.S. sales) or [epson.ca](http://epson.ca) (Canadian sales).

To purchase a replacement remote control, call (562) 276-4394 (U.S.) or (905) 709-3839 (for dealer referral in Canada).

**Parent topic:** [Solving Problems](#)

---

# Technical Specifications

These sections list the technical specifications of your projector.

[General Projector Specifications](#)

[Projector Lamp Specifications](#)

[Remote Control Specifications](#)

[Projector Dimension Specifications](#)

[Projector Electrical Specifications](#)

[Projector Environmental Specifications](#)

[Projector Safety and Approvals Specifications](#)

[Supported Video Display Formats](#)

## General Projector Specifications

<b>Type of display</b>	Poly-silicon TFT active matrix
<b>Resolution</b>	1920 × 1080 pixels (1080p)
<b>Lens</b>	F=2.0 to 3.0 Focal length: 22.5 to 46.7 mm
<b>Color reproduction</b>	Full color, up to 1 billion colors
<b>Brightness</b>	High Power Consumption mode: White light output 2500 lumens (ISO 21118 standard) Color light output 2500 lumens  <b>Note:</b> Color brightness (color light output) and white brightness (white light output) will vary depending on usage conditions. Color light output measured in accordance with IDMS 15.4; white light output measured in accordance with ISO 21118.
<b>Contrast ratio</b>	1,000,000:1 with Auto Iris on, ECO Power Consumption mode, Dynamic Color Mode, Wide Zoom mode, and Lens Shift Vertical: 10:0 and Horizontal: Centered
<b>Image size</b> (in native aspect ratio)	50 inches (1.27 m) to 300 inches (7.62 m)

<b>Projection distance</b> (in native aspect ratio)	58.3 inches (1.48 m) to 747.6 inches (18.99 m)
<b>Projection methods</b>	Front, rear, ceiling-mounted
<b>Optical aspect ratio</b> (width-to-height)	16:9
<b>Focus adjustment</b>	Powered
<b>Zoom adjustment</b>	Optical, powered
<b>Zoom ratio</b> (Tele-to-Wide)	1 to 2.1
<b>Noise level</b>	31 dB (High Power Consumption mode) 20 dB (ECO Power Consumption mode)
<b>Keystone correction angle</b>	± 30° vertical
<b>USB Type B port compatibility</b>	USB 1.1 and 2.0 compliant for service and firmware update
<b>USB Type A port compatibility</b>	Two USB 1.1 and 2.0 compliant ports; one for optional HDMI cable with 300mA power supply and the other for firmware update and Wi-Fi module with 500mA power supply

Parent topic: [Technical Specifications](#)

## Projector Lamp Specifications

<b>Type</b>	UHE (Ultra High Efficiency)
<b>Power consumption</b>	250 W
<b>Lamp life</b>	High Power Consumption mode: Up to about 3500 hours Medium Power Consumption mode: Up to about 4000 hours ECO Power Consumption mode: Up to about 5000 hours

**Note:** Turn off this product when not in use to prolong the life of the projector. Lamp life will vary depending upon mode selected, environmental conditions, and usage. Brightness decreases over time.

Parent topic: [Technical Specifications](#)

## Remote Control Specifications

<b>Reception range</b>	32 feet (10 m)
<b>Batteries</b>	Two alkaline or manganese AA

Parent topic: [Technical Specifications](#)

## Projector Dimension Specifications

<b>Height</b> (excluding feet)	17.7 inches (450 mm)
<b>Width</b>	20.5 inches (520 mm)
<b>Depth</b>	6.7 inches (170 mm)
<b>Weight</b>	<b>PowerLite Home Cinema 5040UB:</b> 24.3 lb (11 kg) <b>PowerLite Home Cinema 5040UBe:</b> 24.7 lb (11.2 kg)

Parent topic: [Technical Specifications](#)

## Projector Electrical Specifications

<b>Rated frequency</b>	50/60 Hz
<b>Power supply</b>	100 to 240 VAC $\pm$ 10% 3.8 to 1.7 A

**Power consumption**

(100 to 120 V)

Operating:

High Power Consumption mode: 373 W

ECO Power Consumption mode: 283 W

Standby:

0.27 W (Communication Off), 2.3 W (Communication On)

**Power consumption**

(220 to 240 V)

Operating:

High Power Consumption mode: 355 W

ECO Power Consumption mode: 271 W

Standby:

0.35 W (Communication Off), 2.4 W (Communication On)

Parent topic: [Technical Specifications](#)

## Projector Environmental Specifications

**Temperature**

Operating: 41 to 95 °F (5 to 35 °C)

Storage: 14 to 140 °F (–10 to 60 °C)

**Humidity** (relative, non-condensing)

Operating: 20 to 80%

Storage: 10 to 90%

**Operating altitude**

Up to 4921 feet (1500 m)

Up to 9843 feet (3000 m) with High Altitude Mode enabled

Parent topic: [Technical Specifications](#)

**Related references**

[Projector Setup Settings - Extended Menu](#)

## Projector Safety and Approvals Specifications

**United States**

FCC Part 15B Class B

UL60950-1 2nd edition (cTUVus Mark)

Parent topic: [Technical Specifications](#)

## Supported Video Display Formats

For best results, your computer's monitor port or video card resolution should be set to display in the projector's native resolution. However, your projector includes Epson's SizeWise chip that supports other computer display resolutions, so your image will be resized to fit automatically.

Your computer's monitor port or video card refresh rate (vertical frequency) must be compatible with the projector. (See your computer or video card manual for details.)

The table here lists the compatible refresh rate and resolution for each compatible video display format.

Display format	Refresh rate (in Hz)	Resolution (in pixels)
<b>Computer signals (analog RGB)</b>		
VGA	60	640 × 480
SVGA	60	800 × 600
XGA	60	1024 × 768
WXGA	60	1280 × 768
	60	1366 × 768
	60	1280 × 800
SXGA	60	1280 × 960
	60	1280 × 1024
WXGA++	60	1600 × 900
<b>HDMI input signals</b>		
VGA	60	640 × 480
SDTV (480i/480p)	60	720 × 480
SDTV (576i/576p)	50	720 × 576
HDTV (720p)	50/60	1280 × 720
HDTV (1080i)	50/60	1920 × 1080

Display format	Refresh rate (in Hz)	Resolution (in pixels)
HDTV (1080p)	24/30/50/60	1920 × 1080
4K × 2K	24/30/50/60	3840 × 2160
	24/50/60	4096 × 2160
<b>WirelessHD Input Signal<sup>1, 2</sup> (PowerLite Home Cinema 5040UBe)</b>		
SDTV (480i/480p)	60	720 × 480
SDTV (576i/576p)	50	720 × 576
HDTV (720p)	50/60	1280 × 720
HDTV (1080i)	50/60	1920 × 1080
HDTV (1080p)	24/30	1920 × 1080
4K × 2K	24/30/50/60	3840 × 2160
	50/60	4096 × 2160
4K × 2K (SMPTE)	24	4096 × 2160
<b>WirelessHD Input Signal MHL<sup>3, 4</sup> (PowerLite Home Cinema 5040UBe)</b>		
SDTV (480i/480p)	60	720 × 480
SDTV (576i/576p)	50	720 × 576
HDTV (720p)	50/60	1280 × 720
HDTV (1080i)	50/60	1920 × 1080
HDTV (1080p)	24/30/50/60	1920 × 1080
4K × 2K	24/25/30	3840 × 2160
4K × 2K (SMPTE)	24	4096 × 2160

<sup>1</sup> When projecting in WirelessHD, the following signals do not support Deep Color:

- 2D: 1080p 50/50 Hz
- 3D: 1080p 24 Hz frame packing, 720p 50/60 Hz frame packing, 1080p 50/60 Hz side by side

<sup>2</sup> When projecting in WirelessHD, the following signals are not supported:

- 4K × 2K: 50/60 Hz
- 4K × 2K (SMPTE): 24 Hz



<sup>3</sup> HDMI4 port only

<sup>4</sup> When projecting in WirelessHD, this signal is not supported: 4K × 2K (SMPTE) 24 Hz

### HDMI 3D Signals

Display format	Refresh rate (in Hz)	Resolution (in pixels)	3D formats
HDTV (720p)	50/60	1280 × 720	Frame Packing Side by Side Top and Bottom
HDTV (1080i)	50/60	1920 × 1080	Side by Side
HDTV (1080p)	50/60	1920 × 1080	Side by Side
	24	1920 × 1080	Frame Packing Side by Side Top and Bottom

### MHL 3D Signals (via WirelessHD Transmitter) (PowerLite Home Cinema 5040UBe)

Display format	Refresh rate (in Hz)	Resolution (in pixels)	3D formats
HDTV (720p)	50/60	1280 × 720	Side by Side Top and Bottom
HDTV (1080i)	50/60	1920 × 1080	Side by Side
HDTV (1080p)	24	1920 × 1080	Side by Side Top and Bottom

Parent topic: [Technical Specifications](#)

---

## Notices

Check these sections for important notices about your projector.

[Recycling](#)

[Important Safety Information](#)

[Important Safety Instructions](#)

[List of Safety Symbols \(corresponding to IEC60950-1 A2\)](#)

[FCC Compliance Statement](#)

[Open Source Software License](#)

[Trademarks](#)

[Copyright Notice](#)

## Recycling

Epson offers a recycling program for end of life products. Please go to [this site](#) for information on how to return your products for proper disposal.

**Parent topic:** [Notices](#)

## Important Safety Information

**Caution:** Never look into the projector lens when the lamp is turned on; the bright light can damage your eyes. Never let children look into the lens when it is on. Never open any cover on the projector, except the lamp and filter covers. Dangerous electrical voltages inside the projector can severely injure you. Except as specifically explained in this *User's Guide*, do not attempt to service this product yourself. Refer all servicing to qualified service personnel.

**Warning:** The projector and its accessories come packaged in plastic bags. Keep plastic bags away from small children to avoid any risk of suffocation.

**Parent topic:** [Notices](#)

## Important Safety Instructions

Follow these safety instructions when setting up and using the projector:

- Do not look into the lens when the projector is on. The bright light can damage your eyes. Avoid standing in front of the projector so the bright light does not shine into your eyes.

- Do not place the projector on an unstable cart, stand, or table.
- Do not operate the projector on its side, or while tilted to one side. Do not tilt the projector more than 3° forward or back.
- If the projector is mounted on a ceiling or wall, it should be installed by qualified technicians using mounting hardware designed for use with this projector.
- When installing or adjusting a ceiling or wall mount, do not use adhesives to prevent the screws from loosening and do not use oils or lubricants. This may cause the projector case to crack and the projector to fall from its ceiling mount. This could cause serious injury to anyone under the mount and could damage the projector.
- Do not use the projector near water, sources of heat, high-voltage electrical wires, or sources of magnetic fields.
- Use the type of power source indicated on the projector. Use of a different power source may result in fire or electric shock. If you are not sure of the power available, consult your dealer or power company.
- Place the projector near a wall outlet where the plug can be easily unplugged.
- Take the following precautions when handling the plug: Do not hold the plug with wet hands. Do not insert the plug into a dusty outlet. Insert the plug firmly into the outlet. Do not pull the power cord when disconnecting the plug; always be sure to hold the plug when disconnecting it. Do not overload wall outlets, extension cords, or power strips. Failure to comply with these precautions could result in fire or electric shock.
- Do not place the projector where the cord can be walked on. This may result in fraying or damage to the plug.
- Unplug the projector from the wall outlet and allow to cool before cleaning. Use a dry cloth (or, for stubborn dirt or stains, a moist cloth that has been wrung dry) for cleaning. Do not use liquid or aerosol cleaners, any sprays containing flammable gas, or solvents such as alcohol, paint thinner, or benzene.
- Do not block the slots and openings in the projector case. They provide ventilation and prevent the projector from overheating. Do not operate the projector on a sofa, rug, or other soft surface, or set it on top of loose papers. Do not cover the projector with a blanket, curtain, or tablecloth. If you are setting up the projector near a wall, leave at least 7.9 inches (20 cm) of space between the wall and the projector.
- Do not operate the projector in a closed-in cabinet unless proper ventilation is provided.
- Never allow objects of any kind to enter any openings in the projector. Do not leave objects, especially flammable objects, near the projector. Never spill liquid of any kind into the projector.
- If you are using two or more projectors side-by-side, leave at least 2 feet (60 cm) of space between the projectors to allow for proper ventilation.

- You may need to clean the air filter and vent. A clogged air filter or vent can block ventilation needed to cool the projector. Do not use canned air, or the gases may leave a residue.
- Do not store the projector outdoors for an extended length of time.
- Except as specifically explained in this manual, do not attempt to service this product yourself. Refer all servicing to qualified personnel. Opening or removing covers may expose you to dangerous voltages and other hazards.
- Never open any covers on the projector except as specifically explained in this manual. Never attempt to disassemble or modify the projector. Refer all repairs to qualified service personnel.
- Unplug the projector from the wall outlet and refer servicing to qualified service personnel under the following conditions: if it does not operate normally when you follow the operating instructions, or exhibits a distinct change in performance; if smoke, strange odors, or strange noises come from the projector; if the power cord or plug is damaged or frayed; if liquid or foreign objects get inside the projector, or if it has been exposed to rain or water; if it has been dropped or the housing has been damaged.
- Do not touch the plug during an electrical storm. Otherwise, you may receive an electric shock.
- Unplug the projector when it will not be used for extended periods.
- Do not use the projector where it may be exposed to rain, water, or excessive humidity.
- Do not use or store the projector where it may be exposed to smoke, steam, corrosive gases, excessive dust, vibration, or shock.
- Do not use the projector where flammable or explosive gases may be present.
- Do not use or store the projector or remote control in a hot location, such as near a heater, in direct sunlight, or in a closed vehicle.
- If you use the projector in a country other than where you purchased it, use the correct power cord for that country.
- Do not stand on the projector or place heavy objects on it.
- Do not use the projector outside of the required temperature range below:  
41 to 95 °F (5 to 35 °C)  
Doing so may cause an unstable display and could lead to projector damage. Do not use or store the projector where it may be exposed to sudden changes in temperature.
- Do not store the projector outside of the required temperature range of 14 to 140 °F (–10 to 60 °C) or in direct sunlight for long periods of time. Doing so may cause damage to the case.

- Do not place anything that can become warped or damaged by heat near the exhaust vents. Do not bring your hands or face close to the vents while projection is in progress. Do not bring your face close to the projector while it is in use.
- Before you move the projector, make sure its power is turned off, the plug is disconnected from the outlet, and all cables are disconnected.
- Do not disassemble the lamp or subject it to impacts.
- Do not place the source of an open flame, such as a lit candle, on or near the projector.
- Do not block the lens during projection using a book or any other object. This could damage the projector or cause a fire.
- Do not modify the power cord. Do not place heavy objects on top of the power cord or bend, twist, or pull it excessively. Keep the power cord away from hot electrical appliances.
- If the lamp breaks, ventilate the room to prevent gases contained in the lamp from being inhaled or coming in contact with your eyes or mouth. If you do inhale gases or gases come in contact with your eyes or mouth, seek medical advice immediately.
- If the projector is mounted overhead and the lamp breaks, be careful to prevent pieces of glass from falling into your eyes or mouth when you open the lamp cover. If pieces of glass do get into your eyes or mouth, seek medical advice immediately.

**Note:**  The lamp(s) in this product contain mercury. Please consult your state and local regulations regarding disposal or recycling. Do not put in the trash.

**WARNING:** The cords included with this product contain chemicals, including lead, known to the State of California to cause birth defects or other reproductive harm. ***Wash hands after handling.*** (This notice is provided in accordance with Proposition 65 in Cal. Health & Safety Code § 25249.5 and following.)

[Restriction of Use](#)

**Parent topic:** [Notices](#)

## Restriction of Use

When this product is used for applications requiring high reliability/safety such as transportation devices related to aviation, rail, marine, automotive; disaster prevention devices; various safety devices; or functional/precision devices, you should use this product only after giving consideration to including fail-safes and redundancies into your design to maintain safety and total system reliability.







Because this product was not intended for use in applications requiring extremely high reliability/safety such as aerospace equipment, main communication equipment, nuclear power control equipment, or





medical equipment related to direct medical care, please make your own judgment on this product's suitability after a full evaluation.





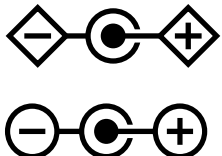

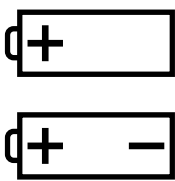
Parent topic: [Important Safety Instructions](#)

## List of Safety Symbols (corresponding to IEC60950-1 A2)



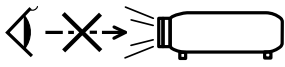

The following table lists the meaning of the safety symbols labeled on the equipment.

No.	Symbol	Approved Standards	Description
1		IEC60417 No.5007	"ON" (power) To indicate connection to the mains.
2		IEC60417 No.5008	"OFF" (power) To indicate disconnection from the mains.
3		IEC60417 No.5009	Stand-by To identify the switch or switch position by means of which part of the equipment is switched on in order to bring it into the stand-by condition.
4		ISO7000 No.0434B IEC3864-B3.1	Caution To identify general caution when using the product.
5		IEC60417 No.5041	Caution, hot surface To indicate that the marked item can be hot and should not be touched without taking care.
6		IEC60417 No.6042 ISO3864-B3.6	Caution, risk of electric shock To identify equipment that has risk of electric shock.

No.	Symbol	Approved Standards	Description
7		IEC60417 No.5957	For indoor use only To identify electrical equipment designed primarily for indoor use.
8		IEC60417 No.5926	Polarity of DC power connector To identify the positive and negative connections (the polarity) on a piece of equipment to which a DC power supply may be connected.
9		IEC60417 No.5001B	Battery, general On battery powered equipment. To identify a device for instance a cover for the battery compartment, or the connector terminals.
10		IEC60417 No.5002	Positioning of cell To identify the battery holder itself and to identify the positioning of the cell(s) inside the battery holder.
11		IEC60417 No.5019	Protective earth To identify any terminal which is intended for connection to an external conductor for protection against electric shock in case of a fault, or the terminal of a protective earth electrode.
12		IEC60417 No.5017	Earth To identify an earth (ground) terminal in cases where neither the symbol No.13 is explicitly required.

No.	Symbol	Approved Standards	Description
13		IEC60417 No.5032	Alternating current To indicate on the rating plate that the equipment is suitable for alternating current only; to identify relevant terminals.
14		IEC60417 No.5031	Direct current To indicate on the rating plate that the equipment is suitable for direct current only; to identify relevant terminals.
15		IEC60417 No.5172	Class II equipment To identify equipment meeting the safety requirements specified for Class II equipment according to IEC 61140.
16		ISO 3864	General prohibition To identify actions or operations that are prohibited.
17		ISO 3864	Contact prohibition To indicate injury that could occur due to touching a specific part of the equipment.
18		—	Never look into the optical lens while the projector is on.
19		—	To indicate that the marked item don't place anything on projector.
20		ISO3864 IEC60825-1	Caution, laser radiation To indicate the equipment has a laser radiation part.



No.	Symbol	Approved Standards	Description
21		ISO 3864	Disassembly prohibition To indicate a risk of injury, such as electric shock, if the equipment is disassembled.
22		—	Never look into the lens while the LED for lighting is on.
23		IEC60417 No. 5266	Standby, partial standby To indicate that part of the equipment is in the ready status.
24		ISO3864 IEC60417 No. 5057	Caution, movable parts To indicate that you must keep away from movable parts according to protection standards.

Parent topic: [Notices](#)

## FCC Compliance Statement

### For United States Users

This equipment has been tested and found to comply with the limits for a Class B digital device, pursuant to Part 15 of the FCC Rules. These limits are designed to provide reasonable protection against harmful interference in a residential installation. This equipment generates, uses, and can radiate radio frequency energy and, if not installed and used in accordance with the instructions, may cause harmful interference to radio communications. However, there is no guarantee that interference will not occur in a particular installation. If this equipment does cause interference to radio and television reception, which can be determined by turning the equipment off and on, the user is encouraged to try to correct the interference by one or more of the following measures:

- Reorient or relocate the receiving antenna.
- Increase the separation between the equipment and receiver.
- Connect the equipment into an outlet on a circuit different from that to which the receiver is connected.
- Consult the dealer or an experienced radio/TV technician for help.

## **WARNING**

The connection of a non-shielded equipment interface cable to this equipment will invalidate the FCC Certification or Declaration of this device and may cause interference levels which exceed the limits established by the FCC for this equipment. It is the responsibility of the user to obtain and use a shielded equipment interface cable with this device. If this equipment has more than one interface connector, do not leave cables connected to unused interfaces. Changes or modifications not expressly approved by the manufacturer could void the user's authority to operate the equipment.

### **For Canadian Users**

CAN ICES-3(B)/NMB-3(B)

Parent topic: [Notices](#)

## **Open Source Software License**

### **GNU GPL**

This projector product includes the open source software programs which apply the GNU General Public License Version 2 or later version ("GPL Programs").

We provide the source code of the GPL Programs until five (5) years after the discontinuation of same model of this projector product.

If you desire to receive the source code of the GPL Programs, contact Epson.

These GPL Programs are WITHOUT ANY WARRANTY; without even the implied warranty of MERCHANTABILITY AND FITNESS FOR A PARTICULAR PURPOSE. See the GNU General Public License for more details.

The list of GPL Programs is as follows and the names of author are described in the source code of the GPL Programs

The list of GPL Programs

- busybox-1.21.0
- iptables-1.4.20
- linux-3.4.49
- patches
- udhcp 0.9.8
- wireless\_tools 29
- dbus-1.6.18

- EPSON original drivers
- Stonestreet One Drivers

The GNU General Public License Version 2 is as follows. You also can see the GNU General Public License Version 2 at <http://www.gnu.org/licenses/>.

## **GNU GENERAL PUBLIC LICENSE**

Version 2, June 1991

Copyright (C) 1989, 1991 Free Software Foundation, Inc., 51 Franklin Street, Fifth Floor, Boston, MA 02110-1301 USA Everyone is permitted to copy and distribute verbatim copies of this license document, but changing it is not allowed.

### **Preamble**

The licenses for most software are designed to take away your freedom to share and change it. By contrast, the GNU General Public License is intended to guarantee your freedom to share and change free software—to make sure the software is free for all its users. This General Public License applies to most of the Free Software Foundation's software and to any other program whose authors commit to using it. (Some other Free Software Foundation software is covered by the GNU Lesser General Public License instead.) You can apply it to your programs, too.

When we speak of free software, we are referring to freedom, not price. Our General Public Licenses are designed to make sure that you have the freedom to distribute copies of free software (and charge for this service if you wish), that you receive source code or can get it if you want it, that you can change the software or use pieces of it in new free programs; and that you know you can do these things.

To protect your rights, we need to make restrictions that forbid anyone to deny you these rights or to ask you to surrender the rights. These restrictions translate to certain responsibilities for you if you distribute copies of the software, or if you modify it.

For example, if you distribute copies of such a program, whether gratis or for a fee, you must give the recipients all the rights that you have. You must make sure that they, too, receive or can get the source code. And you must show them these terms so they know their rights.

We protect your rights with two steps: (1) copyright the software, and (2) offer you this license which gives you legal permission to copy, distribute and/or modify the software.

Also, for each author's protection and ours, we want to make certain that everyone understands that there is no warranty for this free software. If the software is modified by someone else and passed on, we want its recipients to know that what they have is not the original, so that any problems introduced by others will not reflect on the original authors' reputations.

Finally, any free program is threatened constantly by software patents. We wish to avoid the danger that redistributors of a free program will individually obtain patent licenses, in effect making the program

proprietary. To prevent this, we have made it clear that any patent must be licensed for everyone's free use or not licensed at all.

The precise terms and conditions for copying, distribution and modification follow.

## **GNU GENERAL PUBLIC LICENSE TERMS AND CONDITIONS FOR COPYING, DISTRIBUTION AND MODIFICATION**

0. This License applies to any program or other work which contains a notice placed by the copyright holder saying it may be distributed under the terms of this General Public License. The "Program", below, refers to any such program or work, and a "work based on the Program" means either the Program or any derivative work under copyright law: that is to say, a work containing the Program or a portion of it, either verbatim or with modifications and/or translated into another language. (Hereinafter, translation is included without limitation in the term "modification".) Each licensee is addressed as "you".

Activities other than copying, distribution and modification are not covered by this License; they are outside its scope. The act of running the Program is not restricted, and the output from the Program is covered only if its contents constitute a work based on the Program (independent of having been made by running the Program). Whether that is true depends on what the Program does.

1. You may copy and distribute verbatim copies of the Program's source code as you receive it, in any medium, provided that you conspicuously and appropriately publish on each copy an appropriate copyright notice and disclaimer of warranty; keep intact all the notices that refer to this License and to the absence of any warranty; and give any other recipients of the Program a copy of this License along with the Program.

You may charge a fee for the physical act of transferring a copy, and you may at your option offer warranty protection in exchange for a fee.

2. You may modify your copy or copies of the Program or any portion of it, thus forming a work based on the Program, and copy and distribute such modifications or work under the terms of Section 1 above, provided that you also meet all of these conditions:

a) You must cause the modified files to carry prominent notices stating that you changed the files and the date of any change.

b) You must cause any work that you distribute or publish, that in whole or in part contains or is derived from the Program or any part thereof, to be licensed as a whole at no charge to all third parties under the terms of this License.

c) If the modified program normally reads commands interactively when run, you must cause it, when started running for such interactive use in the most ordinary way, to print or display an announcement including an appropriate copyright notice and a notice that there is no warranty (or else, saying that you provide a warranty) and that users may redistribute the program under these conditions, and telling the user how to view a copy of this License. (Exception: if the Program itself is interactive but does not

normally print such an announcement, your work based on the Program is not required to print an announcement.)

These requirements apply to the modified work as a whole. If identifiable sections of that work are not derived from the Program, and can be reasonably considered independent and separate works in themselves, then this License, and its terms, do not apply to those sections when you distribute them as separate works. But when you distribute the same sections as part of a whole which is a work based on the Program, the distribution of the whole must be on the terms of this License, whose permissions for other licensees extend to the entire whole, and thus to each and every part regardless of who wrote it.

Thus, it is not the intent of this section to claim rights or contest your rights to work written entirely by you; rather, the intent is to exercise the right to control the distribution of derivative or collective works based on the Program.

In addition, mere aggregation of another work not based on the Program with the Program (or with a work based on the Program) on a volume of a storage or distribution medium does not bring the other work under the scope of this License.

3. You may copy and distribute the Program (or a work based on it, under Section 2) in object code or executable form under the terms of Sections 1 and 2 above provided that you also do one of the following:

- a) Accompany it with the complete corresponding machine-readable source code, which must be distributed under the terms of Sections 1 and 2 above on a medium customarily used for software interchange; or,
- b) Accompany it with a written offer, valid for at least three years, to give any third party, for a charge no more than your cost of physically performing source distribution, a complete machine-readable copy of the corresponding source code, to be distributed under the terms of Sections 1 and 2 above on a medium customarily used for software interchange; or,
- c) Accompany it with the information you received as to the offer to distribute corresponding source code. (This alternative is allowed only for noncommercial distribution and only if you received the program in object code or executable form with such an offer, in accord with Subsection b above.)

The source code for a work means the preferred form of the work for making modifications to it. For an executable work, complete source code means all the source code for all modules it contains, plus any associated interface definition files, plus the scripts used to control compilation and installation of the executable. However, as a special exception, the source code distributed need not include anything that is normally distributed (in either source or binary form) with the major components (compiler, kernel, and so on) of the operating system on which the executable runs, unless that component itself accompanies the executable.

If distribution of executable or object code is made by offering access to copy from a designated place, then offering equivalent access to copy the source code from the same place counts as distribution of

the source code, even though third parties are not compelled to copy the source along with the object code.

4. You may not copy, modify, sublicense, or distribute the Program except as expressly provided under this License. Any attempt otherwise to copy, modify, sublicense or distribute the Program is void, and will automatically terminate your rights under this License. However, parties who have received copies, or rights, from you under this License will not have their licenses terminated so long as such parties remain in full compliance.

5. You are not required to accept this License, since you have not signed it. However, nothing else grants you permission to modify or distribute the Program or its derivative works. These actions are prohibited by law if you do not accept this License. Therefore, by modifying or distributing the Program (or any work based on the Program), you indicate your acceptance of this License to do so, and all its terms and conditions for copying, distributing or modifying the Program or works based on it.

6. Each time you redistribute the Program (or any work based on the Program), the recipient automatically receives a license from the original licensor to copy, distribute or modify the Program subject to these terms and conditions. You may not impose any further restrictions on the recipients' exercise of the rights granted herein. You are not responsible for enforcing compliance by third parties to this License.

7. If, as a consequence of a court judgment or allegation of patent infringement or for any other reason (not limited to patent issues), conditions are imposed on you (whether by court order, agreement or otherwise) that contradict the conditions of this License, they do not excuse you from the conditions of this License. If you cannot distribute so as to satisfy simultaneously your obligations under this License and any other pertinent obligations, then as a consequence you may not distribute the Program at all. For example, if a patent license would not permit royalty-free redistribution of the Program by all those who receive copies directly or indirectly through you, then the only way you could satisfy both it and this License would be to refrain entirely from distribution of the Program.

If any portion of this section is held invalid or unenforceable under any particular circumstance, the balance of the section is intended to apply and the section as a whole is intended to apply in other circumstances.

It is not the purpose of this section to induce you to infringe any patents or other property right claims or to contest validity of any such claims; this section has the sole purpose of protecting the integrity of the free software distribution system, which is implemented by public license practices. Many people have made generous contributions to the wide range of software distributed through that system in reliance on consistent application of that system; it is up to the author/donor to decide if he or she is willing to distribute software through any other system and a licensee cannot impose that choice.

This section is intended to make thoroughly clear what is believed to be a consequence of the rest of this License.

8. If the distribution and/or use of the Program is restricted in certain countries either by patents or by copyrighted interfaces, the original copyright holder who places the Program under this License may add an explicit geographical distribution limitation excluding those countries, so that distribution is permitted only in or among countries not thus excluded. In such case, this License incorporates the limitation as if written in the body of this License.

9. The Free Software Foundation may publish revised and/or new versions of the General Public License from time to time. Such new versions will be similar in spirit to the present version, but may differ in detail to address new problems or concerns.

Each version is given a distinguishing version number. If the Program specifies a version number of this License which applies to it and "any later version", you have the option of following the terms and conditions either of that version or of any later version published by the Free Software Foundation. If the Program does not specify a version number of this License, you may choose any version ever published by the Free Software Foundation.

10. If you wish to incorporate parts of the Program into other free programs whose distribution conditions are different, write to the author to ask for permission. For software which is copyrighted by the Free Software Foundation, write to the Free Software Foundation; we sometimes make exceptions for this. Our decision will be guided by the two goals of preserving the free status of all derivatives of our free software and of promoting the sharing and reuse of software generally.

#### **NO WARRANTY**

11. BECAUSE THE PROGRAM IS LICENSED FREE OF CHARGE, THERE IS NO WARRANTY FOR THE PROGRAM, TO THE EXTENT PERMITTED BY APPLICABLE LAW. EXCEPT WHEN OTHERWISE STATED IN WRITING THE COPYRIGHT HOLDERS AND/OR OTHER PARTIES PROVIDE THE PROGRAM "AS IS" WITHOUT WARRANTY OF ANY KIND, EITHER EXPRESSED OR IMPLIED, INCLUDING, BUT NOT LIMITED TO, THE IMPLIED WARRANTIES OF MERCHANTABILITY AND FITNESS FOR A PARTICULAR PURPOSE. THE ENTIRE RISK AS TO THE QUALITY AND PERFORMANCE OF THE PROGRAM IS WITH YOU. SHOULD THE PROGRAM PROVE DEFECTIVE, YOU ASSUME THE COST OF ALL NECESSARY SERVICING, REPAIR OR CORRECTION.

12. IN NO EVENT UNLESS REQUIRED BY APPLICABLE LAW OR AGREED TO IN WRITING WILL ANY COPYRIGHT HOLDER, OR ANY OTHER PARTY WHO MAY MODIFY AND/OR REDISTRIBUTE THE PROGRAM AS PERMITTED ABOVE, BE LIABLE TO YOU FOR DAMAGES, INCLUDING ANY GENERAL, SPECIAL, INCIDENTAL OR CONSEQUENTIAL DAMAGES ARISING OUT OF THE USE OR INABILITY TO USE THE PROGRAM (INCLUDING BUT NOT LIMITED TO LOSS OF DATA OR DATA BEING RENDERED INACCURATE OR LOSSES SUSTAINED BY YOU OR THIRD PARTIES OR A FAILURE OF THE PROGRAM TO OPERATE WITH ANY OTHER PROGRAMS), EVEN IF SUCH HOLDER OR OTHER PARTY HAS BEEN ADVISED OF THE POSSIBILITY OF SUCH DAMAGES.

END OF TERMS AND CONDITIONS

## How to Apply These Terms to Your New Programs

If you develop a new program, and you want it to be of the greatest possible use to the public, the best way to achieve this is to make it free software which everyone can redistribute and change under these terms.

To do so, attach the following notices to the program. It is safest to attach them to the start of each source file to most effectively convey the exclusion of warranty; and each file should have at least the "copyright" line and a pointer to where the full notice is found.

<one line to give the program's name and a brief idea of what it does.>

Copyright (C) <year> <name of author>

This program is free software; you can redistribute it and/or modify it under the terms of the GNU General Public License as published by the Free Software Foundation; either version 2 of the License, or (at your option) any later version.

This program is distributed in the hope that it will be useful, but WITHOUT ANY WARRANTY; without even the implied warranty of MERCHANTABILITY or FITNESS FOR A PARTICULAR PURPOSE. See the GNU General Public License for more details.

You should have received a copy of the GNU General Public License along with this program; if not, write to the Free Software Foundation, Inc., 51 Franklin Street, Fifth Floor, Boston, MA 02110-1301 USA.

Also add information on how to contact you by electronic and paper mail.

If the program is interactive, make it output a short notice like this when it starts in an interactive mode:

Gnomovision version 69, Copyright (C) year name of author Gnomovision comes with ABSOLUTELY NO WARRANTY; for details type `show w'. This is free software, and you are welcome to redistribute it under certain conditions; type `show c' for details.

The hypothetical commands `show w' and `show c' should show the appropriate parts of the General Public License. Of course, the commands you use may be called something other than `show w' and `show c'; they could even be mouse-clicks or menu items--whatever suits your program.

You should also get your employer (if you work as a programmer) or your school, if any, to sign a "copyright disclaimer" for the program, if necessary. Here is a sample; alter the names:

Yoyodyne, Inc., hereby disclaims all copyright interest in the program `Gnomovision' (which makes passes at compilers) written by James Hacker.

<signature of Ty Coon>, 1 April 1989

Ty Coon, President of Vice



This General Public License does not permit incorporating your program into proprietary programs. If your program is a subroutine library, you may consider it more useful to permit linking proprietary applications with the library. If this is what you want to do, use the GNU Lesser General Public License instead of this License.

## **GNU LGPL**

This projector product includes the open source software programs which apply the GNU Lesser General Public License Version 2 or later version ("LGPL Programs").

We provide the source code of the LGPL Programs until five (5) years after the discontinuation of same model of this projector product.

If you desire to receive the source code of the LGPL Programs, please contact Epson.

These LGPL Programs are WITHOUT ANY WARRANTY; without even the implied warranty of MERCHANTABILITY AND FITNESS FOR A PARTICULAR PURPOSE. See the GNU General Public License for more details.

The list of LGPL Programs is as follows and the names of author are described in the source code of the LGPL Programs.

LGPL Programs

- SDL-1.2.15
- SDL-Image
- alsa-lib-1.0.27.2
- libdbus-c++-0.9.0
- gencode-3.4.2
- libnl-3.2.24

The GNU Lesser General Public License Version 2 is as follows. You also can see the GNU Lesser General Public License Version 2 at <http://www.gnu.org/licenses/>.

## **GNU LESSER GENERAL PUBLIC LICENSE**

Version 2.1, February 1999

Copyright (C) 1991, 1999 Free Software Foundation, Inc. 51 Franklin Street, Fifth Floor, Boston, MA 02110-1301 USA Everyone is permitted to copy and distribute verbatim copies of this license document, but changing it is not allowed.

[This is the first released version of the Lesser GPL. It also counts as the successor of the GNU Library Public License, version 2, hence the version number 2.1.]

## Preamble

The licenses for most software are designed to take away your freedom to share and change it. By contrast, the GNU General Public Licenses are intended to guarantee your freedom to share and change free software—to make sure the software is free for all its users.

This license, the Lesser General Public License, applies to some specially designated software packages—typically libraries—of the Free Software Foundation and other authors who decide to use it. You can use it too, but we suggest you first think carefully about whether this license or the ordinary General Public License is the better strategy to use in any particular case, based on the explanations below.

When we speak of free software, we are referring to freedom of use, not price. Our General Public Licenses are designed to make sure that you have the freedom to distribute copies of free software (and charge for this service if you wish); that you receive source code or can get it if you want it; that you can change the software and use pieces of it in new free programs; and that you are informed that you can do these things.

To protect your rights, we need to make restrictions that forbid distributors to deny you these rights or to ask you to surrender these rights. These restrictions translate to certain responsibilities for you if you distribute copies of the library or if you modify it.

For example, if you distribute copies of the library, whether gratis or for a fee, you must give the recipients all the rights that we gave you. You must make sure that they, too, receive or can get the source code. If you link other code with the library, you must provide complete object files to the recipients, so that they can relink them with the library after making changes to the library and recompiling it. And you must show them these terms so they know their rights.

We protect your rights with a two-step method: (1) we copyright the library, and (2) we offer you this license, which gives you legal permission to copy, distribute and/or modify the library.

To protect each distributor, we want to make it very clear that there is no warranty for the free library. Also, if the library is modified by someone else and passed on, the recipients should know that what they have is not the original version, so that the original author's reputation will not be affected by problems that might be introduced by others.

Finally, software patents pose a constant threat to the existence of any free program. We wish to make sure that a company cannot effectively restrict the users of a free program by obtaining a restrictive license from a patent holder. Therefore, we insist that any patent license obtained for a version of the library must be consistent with the full freedom of use specified in this license.

Most GNU software, including some libraries, is covered by the ordinary GNU General Public License. This license, the GNU Lesser General Public License, applies to certain designated libraries, and is quite different from the ordinary General Public License. We use this license for certain libraries in order to permit linking those libraries into non-free programs.

When a program is linked with a library, whether statically or using a shared library, the combination of the two is legally speaking a combined work, a derivative of the original library. The ordinary General Public License therefore permits such linking only if the entire combination fits its criteria of freedom. The Lesser General Public License permits more lax criteria for linking other code with the library.

We call this license the "Lesser" General Public License because it does Less to protect the user's freedom than the ordinary General Public License. It also provides other free software developers Less of an advantage over competing non-free programs. These disadvantages are the reason we use the ordinary General Public License for many libraries. However, the Lesser license provides advantages in certain special circumstances.

For example, on rare occasions, there may be a special need to encourage the widest possible use of a certain library, so that it becomes a de-facto standard. To achieve this, non-free programs must be allowed to use the library. A more frequent case is that a free library does the same job as widely used non-free libraries. In this case, there is little to gain by limiting the free library to free software only, so we use the Lesser General Public License.

In other cases, permission to use a particular library in non-free programs enables a greater number of people to use a large body of free software. For example, permission to use the GNU C Library in non-free programs enables many more people to use the whole GNU operating system, as well as its variant, the GNU/Linux operating system.

Although the Lesser General Public License is Less protective of the users' freedom, it does ensure that the user of a program that is linked with the Library has the freedom and the wherewithal to run that program using a modified version of the Library.

The precise terms and conditions for copying, distribution and modification follow. Pay close attention to the difference between a "work based on the library" and a "work that uses the library". The former contains code derived from the library, whereas the latter must be combined with the library in order to run.

## **GNU LESSER GENERAL PUBLIC LICENSE TERMS AND CONDITIONS FOR COPYING, DISTRIBUTION AND MODIFICATION**

0. This License Agreement applies to any software library or other program which contains a notice placed by the copyright holder or other authorized party saying it may be distributed under the terms of this Lesser General Public License (also called "this License"). Each licensee is addressed as "you".

A "library" means a collection of software functions and/or data prepared so as to be conveniently linked with application programs (which use some of those functions and data) to form executables.

The "Library", below, refers to any such software library or work which has been distributed under these terms. A "work based on the Library" means either the Library or any derivative work under copyright law: that is to say, a work containing the Library or a portion of it, either verbatim or with modifications

and/or translated straightforwardly into another language. (Hereinafter, translation is included without limitation in the term "modification".)

"Source code" for a work means the preferred form of the work for making modifications to it. For a library, complete source code means all the source code for all modules it contains, plus any associated interface definition files, plus the scripts used to control compilation and installation of the library.

Activities other than copying, distribution and modification are not covered by this License; they are outside its scope. The act of running a program using the Library is not restricted, and output from such a program is covered only if its contents constitute a work based on the Library (independent of the use of the Library in a tool for writing it). Whether that is true depends on what the Library does and what the program that uses the Library does.

1. You may copy and distribute verbatim copies of the Library's complete source code as you receive it, in any medium, provided that you conspicuously and appropriately publish on each copy an appropriate copyright notice and disclaimer of warranty; keep intact all the notices that refer to this License and to the absence of any warranty; and distribute a copy of this License along with the Library.

You may charge a fee for the physical act of transferring a copy, and you may at your option offer warranty protection in exchange for a fee.

2. You may modify your copy or copies of the Library or any portion of it, thus forming a work based on the Library, and copy and distribute such modifications or work under the terms of Section 1 above, provided that you also meet all of these conditions:

a) The modified work must itself be a software library.

b) You must cause the files modified to carry prominent notices stating that you changed the files and the date of any change.

c) You must cause the whole of the work to be licensed at no charge to all third parties under the terms of this License.

d) If a facility in the modified Library refers to a function or a table of data to be supplied by an application program that uses the facility, other than as an argument passed when the facility is invoked, then you must make a good faith effort to ensure that, in the event an application does not supply such function or table, the facility still operates, and performs whatever part of its purpose remains meaningful.

(For example, a function in a library to compute square roots has a purpose that is entirely well-defined independent of the application. Therefore, Subsection 2d requires that any application-supplied function or table used by this function must be optional: if the application does not supply it, the square root function must still compute square roots.)

These requirements apply to the modified work as a whole. If identifiable sections of that work are not derived from the Library, and can be reasonably considered independent and separate works in themselves, then this License, and its terms, do not apply to those sections when you distribute them as separate works. But when you distribute the same sections as part of a whole which is a work based on

the Library, the distribution of the whole must be on the terms of this License, whose permissions for other licensees extend to the entire whole, and thus to each and every part regardless of who wrote it.

Thus, it is not the intent of this section to claim rights or contest your rights to work written entirely by you; rather, the intent is to exercise the right to control the distribution of derivative or collective works based on the Library.

In addition, mere aggregation of another work not based on the Library with the Library (or with a work based on the Library) on a volume of a storage or distribution medium does not bring the other work under the scope of this License.

3. You may opt to apply the terms of the ordinary GNU General Public License instead of this License to a given copy of the Library. To do this, you must alter all the notices that refer to this License, so that they refer to the ordinary GNU General Public License, version 2, instead of to this License. (If a newer version than version 2 of the ordinary GNU General Public License has appeared, then you can specify that version instead if you wish.) Do not make any other change in these notices.

Once this change is made in a given copy, it is irreversible for that copy, so the ordinary GNU General Public License applies to all subsequent copies and derivative works made from that copy.

This option is useful when you wish to copy part of the code of the Library into a program that is not a library.

4. You may copy and distribute the Library (or a portion or derivative of it, under Section 2) in object code or executable form under the terms of Sections 1 and 2 above provided that you accompany it with the complete corresponding machine-readable source code, which must be distributed under the terms of Sections 1 and 2 above on a medium customarily used for software interchange.

If distribution of object code is made by offering access to copy from a designated place, then offering equivalent access to copy the source code from the same place satisfies the requirement to distribute the source code, even though third parties are not compelled to copy the source along with the object code.

5. A program that contains no derivative of any portion of the Library, but is designed to work with the Library by being compiled or linked with it, is called a "work that uses the Library". Such a work, in isolation, is not a derivative work of the Library, and therefore falls outside the scope of this License.

However, linking a "work that uses the Library" with the Library creates an executable that is a derivative of the Library (because it contains portions of the Library), rather than a "work that uses the library". The executable is therefore covered by this License. Section 6 states terms for distribution of such executables.

When a "work that uses the Library" uses material from a header file that is part of the Library, the object code for the work may be a derivative work of the Library even though the source code is not. Whether this is true is especially significant if the work can be linked without the Library, or if the work is itself a library. The threshold for this to be true is not precisely defined by law.

If such an object file uses only numerical parameters, data structure layouts and accessors, and small macros and small inline functions (ten lines or less in length), then the use of the object file is unrestricted, regardless of whether it is legally a derivative work. (Executables containing this object code plus portions of the Library will still fall under Section 6.)

Otherwise, if the work is a derivative of the Library, you may distribute the object code for the work under the terms of Section 6. Any executables containing that work also fall under Section 6, whether or not they are linked directly with the Library itself.

6. As an exception to the Sections above, you may also combine or link a "work that uses the Library" with the Library to produce a work containing portions of the Library, and distribute that work under terms of your choice, provided that the terms permit modification of the work for the customer's own use and reverse engineering for debugging such modifications.

You must give prominent notice with each copy of the work that the Library is used in it and that the Library and its use are covered by this License. You must supply a copy of this License. If the work during execution displays copyright notices, you must include the copyright notice for the Library among them, as well as a reference directing the user to the copy of this License. Also, you must do one of these things:

a) Accompany the work with the complete corresponding machine-readable source code for the Library including whatever changes were used in the work (which must be distributed under Sections 1 and 2 above); and, if the work is an executable linked with the Library, with the complete machine-readable "work that uses the Library", as object code and/or source code, so that the user can modify the Library and then relink to produce a modified executable containing the modified Library. (It is understood that the user who changes the contents of definitions files in the Library will not necessarily be able to recompile the application to use the modified definitions.)

b) Use a suitable shared library mechanism for linking with the Library. A suitable mechanism is one that (1) uses at run time a copy of the library already present on the user's computer system, rather than copying library functions into the executable, and (2) will operate properly with a modified version of the library, if the user installs one, as long as the modified version is interface-compatible with the version that the work was made with.

c) Accompany the work with a written offer, valid for at least three years, to give the same user the materials specified in Subsection 6a, above, for a charge no more than the cost of performing this distribution.

d) If distribution of the work is made by offering access to copy from a designated place, offer equivalent access to copy the above specified materials from the same place.

e) Verify that the user has already received a copy of these materials or that you have already sent this user a copy.

For an executable, the required form of the "work that uses the Library" must include any data and utility programs needed for reproducing the executable from it. However, as a special exception, the materials

to be distributed need not include anything that is normally distributed (in either source or binary form) with the major components (compiler, kernel, and so on) of the operating system on which the executable runs, unless that component itself accompanies the executable.

It may happen that this requirement contradicts the license restrictions of other proprietary libraries that do not normally accompany the operating system. Such a contradiction means you cannot use both them and the Library together in an executable that you distribute.

7. You may place library facilities that are a work based on the Library side-by-side in a single library together with other library facilities not covered by this License, and distribute such a combined library, provided that the separate distribution of the work based on the Library and of the other library facilities is otherwise permitted, and provided that you do these two things:

a) Accompany the combined library with a copy of the same work based on the Library, uncombined with any other library facilities. This must be distributed under the terms of the Sections above.

b) Give prominent notice with the combined library of the fact that part of it is a work based on the Library, and explaining where to find the accompanying uncombined form of the same work.

8. You may not copy, modify, sublicense, link with, or distribute the Library except as expressly provided under this License. Any attempt otherwise to copy, modify, sublicense, link with, or distribute the Library is void, and will automatically terminate your rights under this License. However, parties who have received copies, or rights, from you under this License will not have their licenses terminated so long as such parties remain in full compliance.

9. You are not required to accept this License, since you have not signed it. However, nothing else grants you permission to modify or distribute the Library or its derivative works. These actions are prohibited by law if you do not accept this License. Therefore, by modifying or distributing the Library (or any work based on the Library), you indicate your acceptance of this License to do so, and all its terms and conditions for copying, distributing or modifying the Library or works based on it.

10. Each time you redistribute the Library (or any work based on the Library), the recipient automatically receives a license from the original licensor to copy, distribute, link with or modify the Library subject to these terms and conditions. You may not impose any further restrictions on the recipients' exercise of the rights granted herein. You are not responsible for enforcing compliance by third parties with this License.

11. If, as a consequence of a court judgment or allegation of patent infringement or for any other reason (not limited to patent issues), conditions are imposed on you (whether by court order, agreement or otherwise) that contradict the conditions of this License, they do not excuse you from the conditions of this License. If you cannot distribute so as to satisfy simultaneously your obligations under this License and any other pertinent obligations, then as a consequence you may not distribute the Library at all. For example, if a patent license would not permit royalty-free redistribution of the Library by all those who receive copies directly or indirectly through you, then the only way you could satisfy both it and this License would be to refrain entirely from distribution of the Library.

If any portion of this section is held invalid or unenforceable under any particular circumstance, the balance of the section is intended to apply, and the section as a whole is intended to apply in other circumstances.

It is not the purpose of this section to induce you to infringe any patents or other property right claims or to contest validity of any such claims; this section has the sole purpose of protecting the integrity of the free software distribution system which is implemented by public license practices. Many people have made generous contributions to the wide range of software distributed through that system in reliance on consistent application of that system; it is up to the author/donor to decide if he or she is willing to distribute software through any other system and a licensee cannot impose that choice.

This section is intended to make thoroughly clear what is believed to be a consequence of the rest of this License.

12. If the distribution and/or use of the Library is restricted in certain countries either by patents or by copyrighted interfaces, the original copyright holder who places the Library under this License may add an explicit geographical distribution limitation excluding those countries, so that distribution is permitted only in or among countries not thus excluded. In such case, this License incorporates the limitation as if written in the body of this License.

13. The Free Software Foundation may publish revised and/or new versions of the Lesser General Public License from time to time. Such new versions will be similar in spirit to the present version, but may differ in detail to address new problems or concerns.

Each version is given a distinguishing version number. If the Library specifies a version number of this License which applies to it and "any later version", you have the option of following the terms and conditions either of that version or of any later version published by the Free Software Foundation. If the Library does not specify a license version number, you may choose any version ever published by the Free Software Foundation.

14. If you wish to incorporate parts of the Library into other free programs whose distribution conditions are incompatible with these, write to the author to ask for permission. For software which is copyrighted by the Free Software Foundation, write to the Free Software Foundation; we sometimes make exceptions for this. Our decision will be guided by the two goals of preserving the free status of all derivatives of our free software and of promoting the sharing and reuse of software generally.

## **NO WARRANTY**

15. BECAUSE THE LIBRARY IS LICENSED FREE OF CHARGE, THERE IS NO WARRANTY FOR THE LIBRARY, TO THE EXTENT PERMITTED BY APPLICABLE LAW. EXCEPT WHEN OTHERWISE STATED IN WRITING THE COPYRIGHT HOLDERS AND/OR OTHER PARTIES PROVIDE THE LIBRARY "AS IS" WITHOUT WARRANTY OF ANY KIND, EITHER EXPRESSED OR IMPLIED, INCLUDING, BUT NOT LIMITED TO, THE IMPLIED WARRANTIES OF MERCHANTABILITY AND FITNESS FOR A PARTICULAR PURPOSE. THE ENTIRE RISK AS TO THE QUALITY AND



PERFORMANCE OF THE LIBRARY IS WITH YOU. SHOULD THE LIBRARY PROVE DEFECTIVE, YOU ASSUME THE COST OF ALL NECESSARY SERVICING, REPAIR OR CORRECTION.

16. IN NO EVENT UNLESS REQUIRED BY APPLICABLE LAW OR AGREED TO IN WRITING WILL ANY COPYRIGHT HOLDER, OR ANY OTHER PARTY WHO MAY MODIFY AND/OR REDISTRIBUTE THE LIBRARY AS PERMITTED ABOVE, BE LIABLE TO YOU FOR DAMAGES, INCLUDING ANY GENERAL, SPECIAL, INCIDENTAL OR CONSEQUENTIAL DAMAGES ARISING OUT OF THE USE OR INABILITY TO USE THE LIBRARY (INCLUDING BUT NOT LIMITED TO LOSS OF DATA OR DATA BEING RENDERED INACCURATE OR LOSSES SUSTAINED BY YOU OR THIRD PARTIES OR A FAILURE OF THE LIBRARY TO OPERATE WITH ANY OTHER SOFTWARE), EVEN IF SUCH HOLDER OR OTHER PARTY HAS BEEN ADVISED OF THE POSSIBILITY OF SUCH DAMAGES.

END OF TERMS AND CONDITIONS

### **How to Apply These Terms to Your New Libraries**

If you develop a new library, and you want it to be of the greatest possible use to the public, we recommend making it free software that everyone can redistribute and change. You can do so by permitting redistribution under these terms (or, alternatively, under the terms of the ordinary General Public License).

To apply these terms, attach the following notices to the library. It is safest to attach them to the start of each source file to most effectively convey the exclusion of warranty; and each file should have at least the "copyright" line and a pointer to where the full notice is found.

<one line to give the library's name and a brief idea of what it does.>

Copyright (C) <year> <name of author>

This library is free software; you can redistribute it and/or modify it under the terms of the GNU Lesser General Public License as published by the Free Software Foundation; either version 2.1 of the License, or (at your option) any later version.

This library is distributed in the hope that it will be useful, but WITHOUT ANY WARRANTY; without even the implied warranty of MERCHANTABILITY or FITNESS FOR A PARTICULAR PURPOSE. See the GNU Lesser General Public License for more details.

You should have received a copy of the GNU Lesser General Public License along with this library; if not, write to the Free Software Foundation, Inc., 51 Franklin Street, Fifth Floor, Boston, MA 02110-1301 USA

Also add information on how to contact you by electronic and paper mail.

You should also get your employer (if you work as a programmer) or your school, if any, to sign a "copyright disclaimer" for the library, if necessary. Here is a sample; alter the names:

Yoyodyne, Inc., hereby disclaims all copyright interest in the library `Frob' (a library for tweaking knobs) written by James Random Hacker.

<signature of Ty Coon>, 1 April 1990

Ty Coon, President of Vice

That's all there is to it!

## **libjpeg**

This projector product includes the open source software program "libjpeg" which applies the terms and conditions provided by owner of the copyright to the "libjpeg".

The "libjpeg" are WITHOUT ANY WARRANTY; without even the implied warranty of MERCHANTABILITY AND FITNESS FOR A PARTICULAR PURPOSE.

List of libjpeg programs

- libjpeg-6b

License terms of conditions of each program which are provided by owner of the copyright to the "libjpeg" are as follows.

Copyright (C) 1994-1997, Thomas G. Lane. This file is part of the Independent JPEG Group's software. For conditions of distribution and use, see the accompanying README file.

This distribution contains the sixth public release of the Independent JPEG Group's free JPEG software. You are welcome to redistribute this software and to use it for any purpose, subject to the conditions under LEGAL ISSUES, below.

## **LEGAL ISSUES**

=====

In plain English:

1. We don't promise that this software works. (But if you find any bugs, please let us know!)
2. You can use this software for whatever you want. You don't have to pay us.
3. You may not pretend that you wrote this software. If you use it in a program, you must acknowledge somewhere in your documentation that you've used the IJG code.

In legalese:

The authors make NO WARRANTY or representation, either express or implied, with respect to this software, its quality, accuracy, merchantability, or fitness for a particular purpose. This software is provided "AS IS", and you, its user, assume the entire risk as to its quality and accuracy.

This software is copyright (C) 1991-1998, Thomas G. Lane. All Rights Reserved except as specified below.

Permission is hereby granted to use, copy, modify, and distribute this software (or portions thereof) for any purpose, without fee, subject to these conditions:

(1) If any part of the source code for this software is distributed, then this README file must be included, with this copyright and no-warranty notice unaltered; and any additions, deletions, or changes to the original files must be clearly indicated in accompanying documentation.

(2) If only executable code is distributed, then the accompanying documentation must state that "this software is based in part on the work of the Independent JPEG Group".

(3) Permission for use of this software is granted only if the user accepts full responsibility for any undesirable consequences; the authors accept NO LIABILITY for damages of any kind.

These conditions apply to any software derived from or based on the IJG code, not just to the unmodified library. If you use our work, you ought to acknowledge us.

Permission is NOT granted for the use of any IJG author's name or company name in advertising or publicity relating to this software or products derived from it. This software may be referred to only as "the Independent JPEG Group's software".

We specifically permit and encourage the use of this software as the basis of commercial products, provided that all warranty or liability claims are assumed by the product vendor.

ansi2knr.c is included in this distribution by permission of L. Peter Deutsch, sole proprietor of its copyright holder, Aladdin Enterprises of Menlo Park, CA. ansi2knr.c is NOT covered by the above copyright and conditions, but instead by the usual distribution terms of the Free Software Foundation; principally, that you must include source code if you redistribute it. (See the file ansi2knr.c for full details.) However, since ansi2knr.c is not needed as part of any program generated from the IJG code, this does not limit you more than the foregoing paragraphs do.

The Unix configuration script "configure" was produced with GNU Autoconf. It is copyright by the Free Software Foundation but is freely distributable. The same holds for its supporting scripts (config.guess, config.sub, ltconfig, ltmain.sh). Another support script, install-sh, is copyright by M.I.T. but is also freely distributable.

It appears that the arithmetic coding option of the JPEG spec is covered by patents owned by IBM, AT&T, and Mitsubishi. Hence arithmetic coding cannot legally be used without obtaining one or more licenses. For this reason, support for arithmetic coding has been removed from the free JPEG software. (Since arithmetic coding provides only a marginal gain over the unpatented Huffman mode, it is unlikely that very many implementations will support it.) So far as we are aware, there are no patent restrictions on the remaining code.

The IJG distribution formerly included code to read and write GIF files. To avoid entanglement with the Unisys LZW patent, GIF reading support has been removed altogether, and the GIF writer has been

simplified to produce "uncompressed GIFs". This technique does not use the LZW algorithm; the resulting GIF files are larger than usual, but are readable by all standard GIF decoders.

We are required to state that "The Graphics Interchange Format(c) is the Copyright property of CompuServe Incorporated. GIF(sm) is a Service Mark property of CompuServe Incorporated."

## **libpng**

This projector product includes the open source software program "libpng" which applies the terms and conditions provided by owner of the copyright to the "libpng".

The "libpng" are WITHOUT ANY WARRANTY; without even the implied warranty of MERCHANTABILITY AND FITNESS FOR A PARTICULAR PURPOSE.

List of libpng programs

- libpng-1.2.49

License terms of conditions of each program which are provided by owner of the copyright to the "libpng" are as follows.

This copy of the libpng notices is provided for your convenience. In case of any discrepancy between this copy and the notices in the file png.h that is included in the libpng distribution, the latter shall prevail.

COPYRIGHT NOTICE, DISCLAIMER, and LICENSE:

If you modify libpng you may insert additional notices immediately following this sentence.

This code is released under the libpng license.

libpng versions 1.2.6, August 15, 2004, through 1.2.49, March 29, 2012, are Copyright (c) 2004, 2006-2009 Glenn Randers-Pehrson, and are distributed according to the same disclaimer and license as libpng-1.2.5 with the following individual added to the list of Contributing Authors

Cosmin Truta

libpng versions 1.0.7, July 1, 2000, through 1.2.5 - October 3, 2002, are Copyright (c) 2000-2002 Glenn Randers-Pehrson, and are distributed according to the same disclaimer and license as libpng-1.0.6 with the following individuals added to the list of Contributing Authors

Simon-Pierre Cadieux

Eric S. Raymond

Gilles Vollant

and with the following additions to the disclaimer:

There is no warranty against interference with your enjoyment of the library or against infringement. There is no warranty that our efforts or the library will fulfill any of your particular purposes or needs. This

library is provided with all faults, and the entire risk of satisfactory quality, performance, accuracy, and effort is with the user.

libpng versions 0.97, January 1998, through 1.0.6, March 20, 2000, are Copyright (c) 1998, 1999 Glenn Randers-Pehrson, and are distributed according to the same disclaimer and license as libpng-0.96, with the following individuals added to the list of Contributing Authors:

Tom Lane

Glenn Randers-Pehrson

Willem van Schaik

libpng versions 0.89, June 1996, through 0.96, May 1997, are Copyright (c) 1996, 1997 Andreas Dilger Distributed according to the same disclaimer and license as libpng-0.88, with the following individuals added to the list of Contributing Authors:

John Bowler

Kevin Bracey

Sam Bushell

Magnus Holmgren

Greg Roelofs

Tom Tanner

libpng versions 0.5, May 1995, through 0.88, January 1996, are Copyright (c) 1995, 1996 Guy Eric Schalnat, Group 42, Inc.

For the purposes of this copyright and license, "Contributing Authors" is defined as the following set of individuals:

Andreas Dilger

Dave Martindale

Guy Eric Schalnat

Paul Schmidt

Tim Wegner

The PNG Reference Library is supplied "AS IS". The Contributing Authors and Group 42, Inc. disclaim all warranties, expressed or implied, including, without limitation, the warranties of merchantability and of fitness for any purpose. The Contributing Authors and Group 42, Inc. assume no liability for direct, indirect, incidental, special, exemplary, or consequential damages, which may result from the use of the PNG Reference Library, even if advised of the possibility of such damage.

Permission is hereby granted to use, copy, modify, and distribute this source code, or portions hereof, for any purpose, without fee, subject to the following restrictions:

1. The origin of this source code must not be misrepresented.
2. Altered versions must be plainly marked as such and must not be misrepresented as being the original source.
3. This Copyright notice may not be removed or altered from any source or altered source distribution.

The Contributing Authors and Group 42, Inc. specifically permit, without fee, and encourage the use of this source code as a component to supporting the PNG file format in commercial products. If you use this source code in a product, acknowledgment is not required but would be appreciated.

A "png\_get\_copyright" function is available, for convenient use in "about" boxes and the like:

```
printf("%s",png_get_copyright(NULL));
```

Also, the PNG logo (in PNG format, of course) is supplied in the files "pngbar.png" and "pngbar.jpg" (88x31) and "pngnow.png" (98x31).

Libpng is OSI Certified Open Source Software. OSI Certified Open Source is a certification mark of the Open Source Initiative.

Glenn Randers-Pehrson

glennrp at users.sourceforge.net

March 29, 2012

### **zlib**

This projector product includes the open source software program "zlib" which applies the terms and conditions provided by owner of the copyright to the "zlib".

The "zlib" are WITHOUT ANY WARRANTY; without even the implied warranty of MERCHANTABILITY AND FITNESS FOR A PARTICULAR PURPOSE.

List of zlib programs

- zlib-1.1.4

License terms of conditions of each program which are provided by owner of the copyright to the "zlib" are as follows.

Copyright notice:

(C) 1995-1998 Jean-loup Gailly and Mark Adler

This software is provided 'as-is', without any express or implied warranty. In no event will the authors be held liable for any damages arising from the use of this software.

Permission is granted to anyone to use this software for any purpose, including commercial applications, and to alter it and redistribute it freely, subject to the following restrictions:

1. The origin of this software must not be misrepresented; you must not claim that you wrote the original software. If you use this software in a product, an acknowledgment in the product documentation would be appreciated but is not required.
2. Altered source versions must be plainly marked as such, and must not be misrepresented as being the original software.
3. This notice may not be removed or altered from any source distribution.

Jean-loup Gailly

jloup@gzip.org

Mark Adler

madler@alumni.caltech.edu

If you use the zlib library in a product, we would appreciate \*not\* receiving lengthy legal documents to sign. The sources are provided for free but without warranty of any kind. The library has been entirely written by Jean-loup Gailly and Mark Adler; it does not include third-party code.

If you redistribute modified sources, we would appreciate that you include in the file ChangeLog history information documenting your changes.

### **Apache-2.0**

This projector product includes the open source software program which applies the terms and conditions provided by owner of the copyright to the "Apache-2.0".

The "Apache-2.0" are WITHOUT ANY WARRANTY; without even the implied warranty of MERCHANTABILITY AND FITNESS FOR A PARTICULAR PURPOSE.

List of Apache-2.0 programs

- mDNSResponder-107.6 (only mDNSResponderPosix is used)

License terms of conditions of each program which are provided by owner of the copyright to the "Apache-2.0" are as follows.

### **Apache License**

Version 2.0, January 2004

<http://www.apache.org/licenses/>

## **TERMS AND CONDITIONS FOR USE, REPRODUCTION, AND DISTRIBUTION**

### 1. Definitions.

"License" shall mean the terms and conditions for use, reproduction, and distribution as defined by Sections 1 through 9 of this document.

"Licensor" shall mean the copyright owner or entity authorized by the copyright owner that is granting the License.

"Legal Entity" shall mean the union of the acting entity and all other entities that control, are controlled by, or are under common control with that entity. For the purposes of this definition, "control" means (i) the power, direct or indirect, to cause the direction or management of such entity, whether by contract or otherwise, or (ii) ownership of fifty percent (50%) or more of the outstanding shares, or (iii) beneficial ownership of such entity.

"You" (or "Your") shall mean an individual or Legal Entity exercising permissions granted by this License.

"Source" form shall mean the preferred form for making modifications, including but not limited to software source code, documentation source, and configuration files.

"Object" form shall mean any form resulting from mechanical transformation or translation of a Source form, including but not limited to compiled object code, generated documentation, and conversions to other media types.

"Work" shall mean the work of authorship, whether in Source or Object form, made available under the License, as indicated by a copyright notice that is included in or attached to the work (an example is provided in the Appendix below).

"Derivative Works" shall mean any work, whether in Source or Object form, that is based on (or derived from) the Work and for which the editorial revisions, annotations, elaborations, or other modifications represent, as a whole, an original work of authorship. For the purposes of this License, Derivative Works shall not include works that remain separable from, or merely link (or bind by name) to the interfaces of, the Work and Derivative Works thereof.

"Contribution" shall mean any work of authorship, including the original version of the Work and any modifications or additions to that Work or Derivative Works thereof, that is intentionally submitted to Licensor for inclusion in the Work by the copyright owner or by an individual or Legal Entity authorized to submit on behalf of the copyright owner. For the purposes of this definition, "submitted" means any form of electronic, verbal, or written communication sent to the Licensor or its representatives, including but not limited to communication on electronic mailing lists, source code control systems, and issue tracking systems that are managed by, or on behalf of, the Licensor for the purpose of discussing and improving the Work, but excluding communication that is conspicuously marked or otherwise designated in writing by the copyright owner as "Not a Contribution."

"Contributor" shall mean Licensor and any individual or Legal Entity on behalf of whom a Contribution has been received by Licensor and subsequently incorporated within the Work.



2. Grant of Copyright License. Subject to the terms and conditions of this License, each Contributor hereby grants to You a perpetual, worldwide, non-exclusive, no-charge, royalty-free, irrevocable copyright license to reproduce, prepare Derivative Works of, publicly display, publicly perform, sublicense, and distribute the Work and such Derivative Works in Source or Object form.

3. Grant of Patent License. Subject to the terms and conditions of this License, each Contributor hereby grants to You a perpetual, worldwide, non-exclusive, no-charge, royalty-free, irrevocable (except as stated in this section) patent license to make, have made, use, offer to sell, sell, import, and otherwise transfer the Work, where such license applies only to those patent claims licensable by such Contributor that are necessarily infringed by their Contribution(s) alone or by combination of their Contribution(s) with the Work to which such Contribution(s) was submitted. If You institute patent litigation against any entity (including a cross-claim or counterclaim in a lawsuit) alleging that the Work or a Contribution incorporated within the Work constitutes direct or contributory patent infringement, then any patent licenses granted to You under this License for that Work shall terminate as of the date such litigation is filed.

4. Redistribution. You may reproduce and distribute copies of the Work or Derivative Works thereof in any medium, with or without modifications, and in Source or Object form, provided that You meet the following conditions:

(a) You must give any other recipients of the Work or Derivative Works a copy of this License; and

(b) You must cause any modified files to carry prominent notices stating that You changed the files; and

(c) You must retain, in the Source form of any Derivative Works that You distribute, all copyright, patent, trademark, and attribution notices from the Source form of the Work, excluding those notices that do not pertain to any part of the Derivative Works; and

(d) If the Work includes a "NOTICE" text file as part of its distribution, then any Derivative Works that You distribute must include a readable copy of the attribution notices contained within such NOTICE file, excluding those notices that do not pertain to any part of the Derivative Works, in at least one of the following places: within a NOTICE text file distributed as part of the Derivative Works; within the Source form or documentation, if provided along with the Derivative Works; or, within a display generated by the Derivative Works, if and wherever such third-party notices normally appear. The contents of the NOTICE file are for informational purposes only and do not modify the License. You may add Your own attribution notices within Derivative Works that You distribute, alongside or as an addendum to the NOTICE text from the Work, provided that such additional attribution notices cannot be construed as modifying the License.

You may add Your own copyright statement to Your modifications and may provide additional or different license terms and conditions for use, reproduction, or distribution of Your modifications, or for any such Derivative Works as a whole, provided Your use, reproduction, and distribution of the Work otherwise complies with the conditions stated in this License.

5. Submission of Contributions. Unless You explicitly state otherwise, any Contribution intentionally submitted for inclusion in the Work by You to the Licensor shall be under the terms and conditions of this License, without any additional terms or conditions.

Notwithstanding the above, nothing herein shall supersede or modify the terms of any separate license agreement you may have executed with Licensor regarding such Contributions.

6. Trademarks. This License does not grant permission to use the trade names, trademarks, service marks, or product names of the Licensor, except as required for reasonable and customary use in describing the origin of the Work and reproducing the content of the NOTICE file.

7. Disclaimer of Warranty. Unless required by applicable law or agreed to in writing, Licensor provides the Work (and each Contributor provides its Contributions) on an "AS IS" BASIS, WITHOUT WARRANTIES OR CONDITIONS OF ANY KIND, either express or implied, including, without limitation, any warranties or conditions of TITLE, NON-INFRINGEMENT, MERCHANTABILITY, or FITNESS FOR A PARTICULAR PURPOSE. You are solely responsible for determining the appropriateness of using or redistributing the Work and assume any risks associated with Your exercise of permissions under this License.

8. Limitation of Liability. In no event and under no legal theory, whether in tort (including negligence), contract, or otherwise, unless required by applicable law (such as deliberate and grossly negligent acts) or agreed to in writing, shall any Contributor be liable to You for damages, including any direct, indirect, special, incidental, or consequential damages of any character arising as a result of this License or out of the use or inability to use the Work (including but not limited to damages for loss of goodwill, work stoppage, computer failure or malfunction, or any and all other commercial damages or losses), even if such Contributor has been advised of the possibility of such damages.

9. Accepting Warranty or Additional Liability. While redistributing the Work or Derivative Works thereof, You may choose to offer, and charge a fee for, acceptance of support, warranty, indemnity, or other liability obligations and/or rights consistent with this License. However, in accepting such obligations, You may act only on Your own behalf and on Your sole responsibility, not on behalf of any other Contributor, and only if You agree to indemnify, defend, and hold each Contributor harmless for any liability incurred by, or claims asserted against, such Contributor by reason of your accepting any such warranty or additional liability.

END OF TERMS AND CONDITIONS

#### **APPENDIX: How to apply the Apache License to your work.**

To apply the Apache License to your work, attach the following boilerplate notice, with the fields enclosed by brackets "[]" replaced with your own identifying information. (Don't include the brackets!) The text should be enclosed in the appropriate comment syntax for the file format. We also recommend that a file or class name and description of purpose be included on the same "printed page" as the copyright notice for easier identification within third-party archives.

Copyright [yyyy] [name of copyright owner]

Licensed under the Apache License, Version 2.0 (the "License");

you may not use this file except in compliance with the License.

You may obtain a copy of the License at <http://www.apache.org/licenses/LICENSE-2.0>

Unless required by applicable law or agreed to in writing, software distributed under the License is distributed on an "AS IS" BASIS, WITHOUT WARRANTIES OR CONDITIONS OF ANY KIND, either express or implied.

See the License for the specific language governing permissions and limitations under the License.

### **aes-src-29-04-09**

This projector product includes the open source software program "aes-src-29-04-09" which applies the terms and conditions provided by owner of the copyright to the "aes-src-29-04-09".

The "aes-src-29-04-09" are WITHOUT ANY WARRANTY; without even the implied warranty of MERCHANTABILITY AND FITNESS FOR A PARTICULAR PURPOSE.

List of aes-src-29-04-09 programs

- aes-src-29-04-09

License terms of conditions of each program which are provided by owner of the copyright to the "aes-src-29-04-09" are as follows.

Copyright (c) 1998-2008, Brian Gladman, Worcester, UK. All rights reserved.

### LICENSE TERMS

The redistribution and use of this software (with or without changes) is allowed without the payment of fees or royalties provided that:

1. source code distributions include the above copyright notice, this list of conditions and the following disclaimer;
2. binary distributions include the above copyright notice, this list of conditions and the following disclaimer in their documentation;.
3. the name of the copyright holder is not used to endorse products built using this software without specific written permission.

### DISCLAIMER

This software is provided 'as is' with no explicit or implied warranties in respect of its properties, including, but not limited to, correctness and/or fitness for purpose.

## **newlib**

This projector product includes the open source software program "newlib" which applies the terms and conditions provided by owner of the copyright to the "newlib".

The "newlib" are WITHOUT ANY WARRANTY; without even the implied warranty of MERCHANTABILITY AND FITNESS FOR A PARTICULAR PURPOSE.

List of newlib programs

- newlib 1.17.0

License terms of conditions of each program which are provided by owner of the copyright to the "newlib" are as follows.

The newlib subdirectory is a collection of software from several sources.

Each file may have its own copyright/license that is embedded in the source file. Unless otherwise noted in the body of the source file(s), the following copyright notices will apply to the contents of the newlib subdirectory:

(1) Red Hat Incorporated

Copyright (c) 1994-2007 Red Hat, Inc. All rights reserved.

This copyrighted material is made available to anyone wishing to use, modify, copy, or redistribute it subject to the terms and conditions of the BSD License. This program is distributed in the hope that it will be useful, but WITHOUT ANY WARRANTY expressed or implied, including the implied warranties of MERCHANTABILITY or FITNESS FOR A PARTICULAR PURPOSE. A copy of this license is available at <http://www.opensource.org/licenses>. Any Red Hat trademarks that are incorporated in the source code or documentation are not subject to the BSD License and may only be used or replicated with the express permission of Red Hat, Inc.

(2) University of California, Berkeley

Copyright (c) 1981-2000 The Regents of the University of California.

All rights reserved.

Redistribution and use in source and binary forms, with or without modification, are permitted provided that the following conditions are met:

\* Redistributions of source code must retain the above copyright notice, this list of conditions and the following disclaimer.

\* Redistributions in binary form must reproduce the above copyright notice, this list of conditions and the following disclaimer in the documentation and/or other materials provided with the distribution.

\* Neither the name of the University nor the names of its contributors may be used to endorse or promote products derived from this software without specific prior written permission.

THIS SOFTWARE IS PROVIDED BY THE COPYRIGHT HOLDERS AND CONTRIBUTORS "AS IS" AND ANY EXPRESS OR IMPLIED WARRANTIES, INCLUDING, BUT NOT LIMITED TO, THE IMPLIED WARRANTIES OF MERCHANTABILITY AND FITNESS FOR A PARTICULAR PURPOSE ARE DISCLAIMED. IN NO EVENT SHALL THE COPYRIGHT OWNER OR CONTRIBUTORS BE LIABLE FOR ANY DIRECT, INDIRECT, INCIDENTAL, SPECIAL, EXEMPLARY, OR CONSEQUENTIAL DAMAGES (INCLUDING, BUT NOT LIMITED TO, PROCUREMENT OF SUBSTITUTE GOODS OR SERVICES; LOSS OF USE, DATA, OR PROFITS; OR BUSINESS INTERRUPTION) HOWEVER CAUSED AND ON ANY THEORY OF LIABILITY, WHETHER IN CONTRACT, STRICT LIABILITY, OR TORT (INCLUDING NEGLIGENCE OR OTHERWISE) ARISING IN ANY WAY OUT OF THE USE OF THIS SOFTWARE, EVEN IF ADVISED OF THE POSSIBILITY OF SUCH DAMAGE.

(3) David M. Gay (AT&T 1991, Lucent 1998)

The author of this software is David M. Gay.

Copyright (c) 1991 by AT&T.

Permission to use, copy, modify, and distribute this software for any purpose without fee is hereby granted, provided that this entire notice is included in all copies of any software which is or includes a copy or modification of this software and in all copies of the supporting documentation for such software.

THIS SOFTWARE IS BEING PROVIDED "AS IS", WITHOUT ANY EXPRESS OR IMPLIED WARRANTY. IN PARTICULAR, NEITHER THE AUTHOR NOR AT&T MAKES ANY REPRESENTATION OR WARRANTY OF ANY KIND CONCERNING THE MERCHANTABILITY OF THIS SOFTWARE OR ITS FITNESS FOR ANY PARTICULAR PURPOSE.

-----

The author of this software is David M. Gay.

Copyright (C) 1998-2001 by Lucent Technologies

All Rights Reserved

Permission to use, copy, modify, and distribute this software and its documentation for any purpose and without fee is hereby granted, provided that the above copyright notice appear in all copies and that both that the copyright notice and this permission notice and warranty disclaimer appear in supporting documentation, and that the name of Lucent or any of its entities not be used in advertising or publicity pertaining to distribution of the software without specific, written prior permission.

LUCENT DISCLAIMS ALL WARRANTIES WITH REGARD TO THIS SOFTWARE, INCLUDING ALL IMPLIED WARRANTIES OF MERCHANTABILITY AND FITNESS. IN NO EVENT SHALL LUCENT OR ANY OF ITS ENTITIES BE LIABLE FOR ANY SPECIAL, INDIRECT OR CONSEQUENTIAL DAMAGES OR ANY DAMAGES WHATSOEVER RESULTING FROM LOSS OF USE, DATA OR PROFITS, WHETHER IN AN ACTION OF CONTRACT, NEGLIGENCE OR OTHER TORTIOUS ACTION, ARISING OUT OF OR IN CONNECTION WITH THE USE OR PERFORMANCE OF THIS SOFTWARE.

(4) Advanced Micro Devices

Copyright 1989, 1990 Advanced Micro Devices, Inc.

This software is the property of Advanced Micro Devices, Inc (AMD) which specifically grants the user the right to modify, use and distribute this software provided this notice is not removed or altered. All other rights are reserved by AMD.

AMD MAKES NO WARRANTY OF ANY KIND, EXPRESS OR IMPLIED, WITH REGARD TO THIS SOFTWARE. IN NO EVENT SHALL AMD BE LIABLE FOR INCIDENTAL OR CONSEQUENTIAL DAMAGES IN CONNECTION WITH OR ARISING FROM THE FURNISHING, PERFORMANCE, OR USE OF THIS SOFTWARE.

So that all may benefit from your experience, please report any problems or suggestions about this software to the 29K Technical Support Center at 800-29-29-AMD (800-292-9263) in the USA, or 0800-89-1131 in the UK, or 0031-11-1129 in Japan, toll free. The direct dial number is 512-462-4118.

Advanced Micro Devices, Inc.

29K Support Products

Mail Stop 573

5900 E. Ben White Blvd.

Austin, TX 78741

800-292-9263

(5) C.W. Sandmann

Copyright (C) 1993 C.W. Sandmann

This file may be freely distributed as long as the author's name remains.

(6) Eric Backus

(C) Copyright 1992 Eric Backus

This software may be used freely so long as this copyright notice is left intact. There is no warrantee on this software.

(7) Sun Microsystems

Copyright (C) 1993 by Sun Microsystems, Inc. All rights reserved.

Developed at SunPro, a Sun Microsystems, Inc. business. Permission to use, copy, modify, and distribute this software is freely granted, provided that this notice is preserved.

(8) Hewlett Packard

(c) Copyright 1986 HEWLETT-PACKARD COMPANY

To anyone who acknowledges that this file is provided "AS IS" without any express or implied warranty: permission to use, copy, modify, and distribute this file for any purpose is hereby granted without fee, provided that the above copyright notice and this notice appears in all copies, and that the name of Hewlett-Packard Company not be used in advertising or publicity pertaining to distribution of the software without specific, written prior permission. Hewlett-Packard Company makes no representations about the suitability of this software for any purpose.

(9) Hans-Peter Nilsson

Copyright (C) 2001 Hans-Peter Nilsson

Permission to use, copy, modify, and distribute this software is freely granted, provided that the above copyright notice, this notice and the following disclaimer are preserved with no changes.

THIS SOFTWARE IS PROVIDED "AS IS" AND WITHOUT ANY EXPRESS OR IMPLIED WARRANTIES, INCLUDING, WITHOUT LIMITATION, THE IMPLIED WARRANTIES OF MERCHANTABILITY AND FITNESS FOR A PARTICULAR PURPOSE.

(11) Christopher G. Demetriou

Copyright (c) 2001 Christopher G. Demetriou

All rights reserved.

Redistribution and use in source and binary forms, with or without modification, are permitted provided that the following conditions are met:

1. Redistributions of source code must retain the above copyright notice, this list of conditions and the following disclaimer.
2. Redistributions in binary form must reproduce the above copyright notice, this list of conditions and the following disclaimer in the documentation and/or other materials provided with the distribution.
3. The name of the author may not be used to endorse or promote products derived from this software without specific prior written permission.

THIS SOFTWARE IS PROVIDED BY THE AUTHOR "AS IS" AND ANY EXPRESS OR IMPLIED WARRANTIES, INCLUDING, BUT NOT LIMITED TO, THE IMPLIED WARRANTIES OF MERCHANTABILITY AND FITNESS FOR A PARTICULAR PURPOSE ARE DISCLAIMED. IN NO EVENT SHALL THE AUTHOR BE LIABLE FOR ANY DIRECT, INDIRECT, INCIDENTAL, SPECIAL, EXEMPLARY, OR CONSEQUENTIAL DAMAGES (INCLUDING, BUT NOT LIMITED TO, PROCUREMENT OF SUBSTITUTE GOODS OR SERVICES; LOSS OF USE, DATA, OR PROFITS; OR BUSINESS INTERRUPTION) HOWEVER CAUSED AND ON ANY THEORY OF LIABILITY, WHETHER IN CONTRACT, STRICT LIABILITY, OR TORT (INCLUDING NEGLIGENCE OR OTHERWISE) ARISING IN ANY WAY OUT OF THE USE OF THIS SOFTWARE, EVEN IF ADVISED OF THE POSSIBILITY OF SUCH DAMAGE.

(12) SuperH, Inc.

Copyright 2002 SuperH, Inc. All rights reserved

This software is the property of SuperH, Inc (SuperH) which specifically grants the user the right to modify, use and distribute this software provided this notice is not removed or altered. All other rights are reserved by SuperH.

SUPERH MAKES NO WARRANTY OF ANY KIND, EXPRESS OR IMPLIED, WITH REGARD TO THIS SOFTWARE. IN NO EVENT SHALL SUPERH BE LIABLE FOR INDIRECT, SPECIAL, INCIDENTAL OR CONSEQUENTIAL DAMAGES IN CONNECTION WITH OR ARISING FROM THE FURNISHING, PERFORMANCE, OR USE OF THIS SOFTWARE.

So that all may benefit from your experience, please report any problems or suggestions about this software to the SuperH Support Center via e-mail at [softwaresupport@superh.com](mailto:softwaresupport@superh.com).

SuperH, Inc.

405 River Oaks Parkway

San Jose

CA 95134

USA

(13) Royal Institute of Technology

Copyright (c) 1999 Kungliga Tekniska Högskolan (Royal Institute of Technology, Stockholm, Sweden).

All rights reserved.

Redistribution and use in source and binary forms, with or without modification, are permitted provided that the following conditions are met:

1. Redistributions of source code must retain the above copyright notice, this list of conditions and the following disclaimer.
2. Redistributions in binary form must reproduce the above copyright notice, this list of conditions and the following disclaimer in the documentation and/or other materials provided with the distribution.
3. Neither the name of KTH nor the names of its contributors may be used to endorse or promote products derived from this software without specific prior written permission.

THIS SOFTWARE IS PROVIDED BY KTH AND ITS CONTRIBUTORS "AS IS" AND ANY EXPRESS OR IMPLIED WARRANTIES, INCLUDING, BUT NOT LIMITED TO, THE IMPLIED WARRANTIES OF MERCHANTABILITY AND FITNESS FOR A PARTICULAR PURPOSE ARE DISCLAIMED. IN NO EVENT SHALL KTH OR ITS CONTRIBUTORS BE LIABLE FOR ANY DIRECT, INDIRECT, INCIDENTAL, SPECIAL, EXEMPLARY, OR CONSEQUENTIAL DAMAGES (INCLUDING, BUT NOT LIMITED TO, PROCUREMENT OF SUBSTITUTE GOODS OR SERVICES; LOSS OF USE, DATA, OR PROFITS; OR BUSINESS INTERRUPTION) HOWEVER CAUSED AND ON ANY THEORY OF



LIABILITY, WHETHER IN CONTRACT, STRICT LIABILITY, OR TORT (INCLUDING NEGLIGENCE OR OTHERWISE) ARISING IN ANY WAY OUT OF THE USE OF THIS SOFTWARE, EVEN IF ADVISED OF THE POSSIBILITY OF SUCH DAMAGE.

(14) Alexey Zelkin

Copyright (c) 2000, 2001 Alexey Zelkin <phantom@FreeBSD.org>

All rights reserved.

Redistribution and use in source and binary forms, with or without modification, are permitted provided that the following conditions are met:

1. Redistributions of source code must retain the above copyright notice, this list of conditions and the following disclaimer.
2. Redistributions in binary form must reproduce the above copyright notice, this list of conditions and the following disclaimer in the documentation and/or other materials provided with the distribution.

THIS SOFTWARE IS PROVIDED BY THE AUTHOR AND CONTRIBUTORS "AS IS" AND ANY EXPRESS OR IMPLIED WARRANTIES, INCLUDING, BUT NOT LIMITED TO, THE IMPLIED WARRANTIES OF MERCHANTABILITY AND FITNESS FOR A PARTICULAR PURPOSE ARE DISCLAIMED. IN NO EVENT SHALL THE AUTHOR OR CONTRIBUTORS BE LIABLE FOR ANY DIRECT, INDIRECT, INCIDENTAL, SPECIAL, EXEMPLARY, OR CONSEQUENTIAL DAMAGES (INCLUDING, BUT NOT LIMITED TO, PROCUREMENT OF SUBSTITUTE GOODS OR SERVICES; LOSS OF USE, DATA, OR PROFITS; OR BUSINESS INTERRUPTION) HOWEVER CAUSED AND ON ANY THEORY OF LIABILITY, WHETHER IN CONTRACT, STRICT LIABILITY, OR TORT (INCLUDING NEGLIGENCE OR OTHERWISE) ARISING IN ANY WAY OUT OF THE USE OF THIS SOFTWARE, EVEN IF ADVISED OF THE POSSIBILITY OF SUCH DAMAGE.

(15) Andrey A. Chernov

Copyright (C) 1997 by Andrey A. Chernov, Moscow, Russia.

All rights reserved.

Redistribution and use in source and binary forms, with or without modification, are permitted provided that the following conditions are met:

1. Redistributions of source code must retain the above copyright notice, this list of conditions and the following disclaimer.
2. Redistributions in binary form must reproduce the above copyright notice, this list of conditions and the following disclaimer in the documentation and/or other materials provided with the distribution.

THIS SOFTWARE IS PROVIDED BY THE AUTHOR "AS IS" AND ANY EXPRESS OR IMPLIED WARRANTIES, INCLUDING, BUT NOT LIMITED TO, THE IMPLIED WARRANTIES OF MERCHANTABILITY AND FITNESS FOR A PARTICULAR PURPOSE ARE DISCLAIMED. IN NO

EVENT SHALL THE REGENTS OR CONTRIBUTORS BE LIABLE FOR ANY DIRECT, INDIRECT, INCIDENTAL, SPECIAL, EXEMPLARY, OR CONSEQUENTIAL DAMAGES (INCLUDING, BUT NOT LIMITED TO, PROCUREMENT OF SUBSTITUTE GOODS OR SERVICES; LOSS OF USE, DATA, OR PROFITS; OR BUSINESS INTERRUPTION) HOWEVER CAUSED AND ON ANY THEORY OF LIABILITY, WHETHER IN CONTRACT, STRICT LIABILITY, OR TORT (INCLUDING NEGLIGENCE OR OTHERWISE) ARISING IN ANY WAY OUT OF THE USE OF THIS SOFTWARE, EVEN IF ADVISED OF THE POSSIBILITY OF SUCH DAMAGE.

(16) FreeBSD

Copyright (c) 1997-2002 FreeBSD Project.

All rights reserved.

Redistribution and use in source and binary forms, with or without modification, are permitted provided that the following conditions are met:

1. Redistributions of source code must retain the above copyright notice, this list of conditions and the following disclaimer.
2. Redistributions in binary form must reproduce the above copyright notice, this list of conditions and the following disclaimer in the documentation and/or other materials provided with the distribution.

THIS SOFTWARE IS PROVIDED BY THE AUTHOR AND CONTRIBUTORS "AS IS" AND ANY EXPRESS OR IMPLIED WARRANTIES, INCLUDING, BUT NOT LIMITED TO, THE IMPLIED WARRANTIES OF MERCHANTABILITY AND FITNESS FOR A PARTICULAR PURPOSE ARE DISCLAIMED. IN NO EVENT SHALL THE AUTHOR OR CONTRIBUTORS BE LIABLE FOR ANY DIRECT, INDIRECT, INCIDENTAL, SPECIAL, EXEMPLARY, OR CONSEQUENTIAL DAMAGES (INCLUDING, BUT NOT LIMITED TO, PROCUREMENT OF SUBSTITUTE GOODS OR SERVICES; LOSS OF USE, DATA, OR PROFITS; OR BUSINESS INTERRUPTION) HOWEVER CAUSED AND ON ANY THEORY OF LIABILITY, WHETHER IN CONTRACT, STRICT LIABILITY, OR TORT (INCLUDING NEGLIGENCE OR OTHERWISE) ARISING IN ANY WAY OUT OF THE USE OF THIS SOFTWARE, EVEN IF ADVISED OF THE POSSIBILITY OF SUCH DAMAGE.

(17) S. L. Moshier

Author: S. L. Moshier.

Copyright (c) 1984,2000 S.L. Moshier

Permission to use, copy, modify, and distribute this software for any purpose without fee is hereby granted, provided that this entire notice is included in all copies of any software which is or includes a copy or modification of this software and in all copies of the supporting documentation for such software.

THIS SOFTWARE IS BEING PROVIDED "AS IS", WITHOUT ANY EXPRESS OR IMPLIED WARRANTY. IN PARTICULAR, THE AUTHOR MAKES NO REPRESENTATION OR WARRANTY OF

ANY KIND CONCERNING THE MERCHANTABILITY OF THIS SOFTWARE OR ITS FITNESS FOR ANY PARTICULAR PURPOSE.

(18) Citrus Project

Copyright (c)1999 Citrus Project,

All rights reserved.

Redistribution and use in source and binary forms, with or without modification, are permitted provided that the following conditions are met:

1. Redistributions of source code must retain the above copyright notice, this list of conditions and the following disclaimer.
2. Redistributions in binary form must reproduce the above copyright notice, this list of conditions and the following disclaimer in the documentation and/or other materials provided with the distribution.

THIS SOFTWARE IS PROVIDED BY THE AUTHOR AND CONTRIBUTORS "AS IS" AND ANY EXPRESS OR IMPLIED WARRANTIES, INCLUDING, BUT NOT LIMITED TO, THE IMPLIED WARRANTIES OF MERCHANTABILITY AND FITNESS FOR A PARTICULAR PURPOSE ARE DISCLAIMED. IN NO EVENT SHALL THE AUTHOR OR CONTRIBUTORS BE LIABLE FOR ANY DIRECT, INDIRECT, INCIDENTAL, SPECIAL, EXEMPLARY, OR CONSEQUENTIAL DAMAGES (INCLUDING, BUT NOT LIMITED TO, PROCUREMENT OF SUBSTITUTE GOODS OR SERVICES; LOSS OF USE, DATA, OR PROFITS; OR BUSINESS INTERRUPTION) HOWEVER CAUSED AND ON ANY THEORY OF LIABILITY, WHETHER IN CONTRACT, STRICT LIABILITY, OR TORT (INCLUDING NEGLIGENCE OR OTHERWISE) ARISING IN ANY WAY OUT OF THE USE OF THIS SOFTWARE, EVEN IF ADVISED OF THE POSSIBILITY OF SUCH DAMAGE.

(19) Todd C. Miller

Copyright (c) 1998 Todd C. Miller <Todd.Miller@courtesan.com>

All rights reserved.

Redistribution and use in source and binary forms, with or without modification, are permitted provided that the following conditions are met:

1. Redistributions of source code must retain the above copyright notice, this list of conditions and the following disclaimer.
2. Redistributions in binary form must reproduce the above copyright notice, this list of conditions and the following disclaimer in the documentation and/or other materials provided with the distribution.
3. The name of the author may not be used to endorse or promote products derived from this software without specific prior written permission.

THIS SOFTWARE IS PROVIDED "AS IS" AND ANY EXPRESS OR IMPLIED WARRANTIES, INCLUDING, BUT NOT LIMITED TO, THE IMPLIED WARRANTIES OF MERCHANTABILITY AND

FITNESS FOR A PARTICULAR PURPOSE ARE DISCLAIMED. IN NO EVENT SHALL THE AUTHOR BE LIABLE FOR ANY DIRECT, INDIRECT, INCIDENTAL, SPECIAL, EXEMPLARY, OR CONSEQUENTIAL DAMAGES (INCLUDING, BUT NOT LIMITED TO, PROCUREMENT OF SUBSTITUTE GOODS OR SERVICES; LOSS OF USE, DATA, OR PROFITS; OR BUSINESS INTERRUPTION) HOWEVER CAUSED AND ON ANY THEORY OF LIABILITY, WHETHER IN CONTRACT, STRICT LIABILITY, OR TORT (INCLUDING NEGLIGENCE OR OTHERWISE) ARISING IN ANY WAY OUT OF THE USE OF THIS SOFTWARE, EVEN IF ADVISED OF THE POSSIBILITY OF SUCH DAMAGE.

(20) DJ Delorie (i386)

Copyright (C) 1991 DJ Delorie

All rights reserved.

Redistribution and use in source and binary forms is permitted provided that the above copyright notice and following paragraph are duplicated in all such forms.

This file is distributed WITHOUT ANY WARRANTY; without even the implied warranty of MERCHANTABILITY or FITNESS FOR A PARTICULAR PURPOSE.

(23) Intel (i960)

Copyright (c) 1993 Intel Corporation

Intel hereby grants you permission to copy, modify, and distribute this software and its documentation. Intel grants this permission provided that the above copyright notice appears in all copies and that both the copyright notice and this permission notice appear in supporting documentation. In addition, Intel grants this permission provided that you prominently mark as "not part of the original" any modifications made to this software or documentation, and that the name of Intel Corporation not be used in advertising or publicity pertaining to distribution of the software or the documentation without specific, written prior permission.

Intel Corporation provides this AS IS, WITHOUT ANY WARRANTY, EXPRESS OR IMPLIED, INCLUDING, WITHOUT LIMITATION, ANY WARRANTY OF MERCHANTABILITY OR FITNESS FOR A PARTICULAR PURPOSE. Intel makes no guarantee or representations regarding the use of, or the results of the use of, the software and documentation in terms of correctness, accuracy, reliability, currentness, or otherwise; and you rely on the software, documentation and results solely at your own risk.

IN NO EVENT SHALL INTEL BE LIABLE FOR ANY LOSS OF USE, LOSS OF BUSINESS, LOSS OF PROFITS, INDIRECT, INCIDENTAL, SPECIAL OR CONSEQUENTIAL DAMAGES OF ANY KIND. IN NO EVENT SHALL INTEL'S TOTAL LIABILITY EXCEED THE SUM PAID TO INTEL FOR THE PRODUCT LICENSED HEREUNDER.

(26) Mike Barcroft

Copyright (c) 2001 Mike Barcroft <mike@FreeBSD.org>

All rights reserved.

Redistribution and use in source and binary forms, with or without modification, are permitted provided that the following conditions are met:

1. Redistributions of source code must retain the above copyright notice, this list of conditions and the following disclaimer.
2. Redistributions in binary form must reproduce the above copyright notice, this list of conditions and the following disclaimer in the documentation and/or other materials provided with the distribution.

THIS SOFTWARE IS PROVIDED BY THE AUTHOR AND CONTRIBUTORS "AS IS" AND ANY EXPRESS OR IMPLIED WARRANTIES, INCLUDING, BUT NOT LIMITED TO, THE IMPLIED WARRANTIES OF MERCHANTABILITY AND FITNESS FOR A PARTICULAR PURPOSE ARE DISCLAIMED. IN NO EVENT SHALL THE AUTHOR OR CONTRIBUTORS BE LIABLE FOR ANY DIRECT, INDIRECT, INCIDENTAL, SPECIAL, EXEMPLARY, OR CONSEQUENTIAL DAMAGES (INCLUDING, BUT NOT LIMITED TO, PROCUREMENT OF SUBSTITUTE GOODS OR SERVICES; LOSS OF USE, DATA, OR PROFITS; OR BUSINESS INTERRUPTION) HOWEVER CAUSED AND ON ANY THEORY OF LIABILITY, WHETHER IN CONTRACT, STRICT LIABILITY, OR TORT (INCLUDING NEGLIGENCE OR OTHERWISE) ARISING IN ANY WAY OUT OF THE USE OF THIS SOFTWARE, EVEN IF ADVISED OF THE POSSIBILITY OF SUCH DAMAGE.

(27) Konstantin Chuguev (--enable-newlib-iconv)

Copyright (c) 1999, 2000

Konstantin Chuguev. All rights reserved.

Redistribution and use in source and binary forms, with or without modification, are permitted provided that the following conditions are met:

1. Redistributions of source code must retain the above copyright notice, this list of conditions and the following disclaimer.
2. Redistributions in binary form must reproduce the above copyright notice, this list of conditions and the following disclaimer in the documentation and/or other materials provided with the distribution.

THIS SOFTWARE IS PROVIDED BY THE AUTHOR AND CONTRIBUTORS "AS IS" AND ANY EXPRESS OR IMPLIED WARRANTIES, INCLUDING, BUT NOT LIMITED TO, THE IMPLIED WARRANTIES OF MERCHANTABILITY AND FITNESS FOR A PARTICULAR PURPOSE ARE DISCLAIMED. IN NO EVENT SHALL THE AUTHOR OR CONTRIBUTORS BE LIABLE FOR ANY DIRECT, INDIRECT, INCIDENTAL, SPECIAL, EXEMPLARY, OR CONSEQUENTIAL DAMAGES (INCLUDING, BUT NOT LIMITED TO, PROCUREMENT OF SUBSTITUTE GOODS OR SERVICES; LOSS OF USE, DATA, OR PROFITS; OR BUSINESS INTERRUPTION) HOWEVER CAUSED AND ON ANY THEORY OF LIABILITY, WHETHER IN CONTRACT, STRICT LIABILITY, OR TORT (INCLUDING

NEGLIGENCE OR OTHERWISE) ARISING IN ANY WAY OUT OF THE USE OF THIS SOFTWARE, EVEN IF ADVISED OF THE POSSIBILITY OF SUCH DAMAGE.

iconv (Charset Conversion Library) v2.0

(28) Artem Bityuckiy (--enable-newlib-iconv)

Copyright (c) 2003, Artem B. Bityuckiy, SoftMine Corporation. Rights transferred to Franklin Electronic Publishers.

Redistribution and use in source and binary forms, with or without modification, are permitted provided that the following conditions are met:

1. Redistributions of source code must retain the above copyright notice, this list of conditions and the following disclaimer.
2. Redistributions in binary form must reproduce the above copyright notice, this list of conditions and the following disclaimer in the documentation and/or other materials provided with the distribution.

THIS SOFTWARE IS PROVIDED BY THE AUTHOR AND CONTRIBUTORS "AS IS" AND ANY EXPRESS OR IMPLIED WARRANTIES, INCLUDING, BUT NOT LIMITED TO, THE IMPLIED WARRANTIES OF MERCHANTABILITY AND FITNESS FOR A PARTICULAR PURPOSE ARE DISCLAIMED. IN NO EVENT SHALL THE AUTHOR OR CONTRIBUTORS BE LIABLE FOR ANY DIRECT, INDIRECT, INCIDENTAL, SPECIAL, EXEMPLARY, OR CONSEQUENTIAL DAMAGES (INCLUDING, BUT NOT LIMITED TO, PROCUREMENT OF SUBSTITUTE GOODS OR SERVICES; LOSS OF USE, DATA, OR PROFITS; OR BUSINESS INTERRUPTION) HOWEVER CAUSED AND ON ANY THEORY OF LIABILITY, WHETHER IN CONTRACT, STRICT LIABILITY, OR TORT (INCLUDING NEGLIGENCE OR OTHERWISE) ARISING IN ANY WAY OUT OF THE USE OF THIS SOFTWARE, EVEN IF ADVISED OF THE POSSIBILITY OF SUCH DAMAGE.

(30) - Alex Tatmanjants (targets using libc/posix)

Copyright (c) 1995 Alex Tatmanjants <alex@elvisti.kiev.ua>

at Electronni Visti IA, Kiev, Ukraine.

All rights reserved.

Redistribution and use in source and binary forms, with or without modification, are permitted provided that the following conditions are met:

1. Redistributions of source code must retain the above copyright notice, this list of conditions and the following disclaimer.
2. Redistributions in binary form must reproduce the above copyright notice, this list of conditions and the following disclaimer in the documentation and/or other materials provided with the distribution.

THIS SOFTWARE IS PROVIDED BY THE AUTHOR "AS IS" AND ANY EXPRESS OR IMPLIED WARRANTIES, INCLUDING, BUT NOT LIMITED TO, THE IMPLIED WARRANTIES OF

MERCHANTABILITY AND FITNESS FOR A PARTICULAR PURPOSE ARE DISCLAIMED. IN NO EVENT SHALL THE AUTHOR BE LIABLE FOR ANY DIRECT, INDIRECT, INCIDENTAL, SPECIAL, EXEMPLARY, OR CONSEQUENTIAL DAMAGES (INCLUDING, BUT NOT LIMITED TO, PROCUREMENT OF SUBSTITUTE GOODS OR SERVICES; LOSS OF USE, DATA, OR PROFITS; OR BUSINESS INTERRUPTION) HOWEVER CAUSED AND ON ANY THEORY OF LIABILITY, WHETHER IN CONTRACT, STRICT LIABILITY, OR TORT (INCLUDING NEGLIGENCE OR OTHERWISE) ARISING IN ANY WAY OUT OF THE USE OF THIS SOFTWARE, EVEN IF ADVISED OF THE POSSIBILITY OF SUCH DAMAGE.

(31) - M. Warner Losh (targets using libc/posix)

Copyright (c) 1998, M. Warner Losh <imp@freebsd.org>

All rights reserved.

Redistribution and use in source and binary forms, with or without modification, are permitted provided that the following conditions are met:

1. Redistributions of source code must retain the above copyright notice, this list of conditions and the following disclaimer.
2. Redistributions in binary form must reproduce the above copyright notice, this list of conditions and the following disclaimer in the documentation and/or other materials provided with the distribution.

THIS SOFTWARE IS PROVIDED BY THE AUTHOR AND CONTRIBUTORS "AS IS" AND ANY EXPRESS OR IMPLIED WARRANTIES, INCLUDING, BUT NOT LIMITED TO, THE IMPLIED WARRANTIES OF MERCHANTABILITY AND FITNESS FOR A PARTICULAR PURPOSE ARE DISCLAIMED. IN NO EVENT SHALL THE AUTHOR OR CONTRIBUTORS BE LIABLE FOR ANY DIRECT, INDIRECT, INCIDENTAL, SPECIAL, EXEMPLARY, OR CONSEQUENTIAL DAMAGES (INCLUDING, BUT NOT LIMITED TO, PROCUREMENT OF SUBSTITUTE GOODS OR SERVICES; LOSS OF USE, DATA, OR PROFITS; OR BUSINESS INTERRUPTION) HOWEVER CAUSED AND ON ANY THEORY OF LIABILITY, WHETHER IN CONTRACT, STRICT LIABILITY, OR TORT (INCLUDING NEGLIGENCE OR OTHERWISE) ARISING IN ANY WAY OUT OF THE USE OF THIS SOFTWARE, EVEN IF ADVISED OF THE POSSIBILITY OF SUCH DAMAGE.

(32) - Andrey A. Chernov (targets using libc/posix)

Copyright (C) 1996 by Andrey A. Chernov, Moscow, Russia.

All rights reserved.

Redistribution and use in source and binary forms, with or without modification, are permitted provided that the following conditions are met:

1. Redistributions of source code must retain the above copyright notice, this list of conditions and the following disclaimer.

2. Redistributions in binary form must reproduce the above copyright notice, this list of conditions and the following disclaimer in the documentation and/or other materials provided with the distribution.

THIS SOFTWARE IS PROVIDED BY THE AUTHOR "AS IS" AND ANY EXPRESS OR IMPLIED WARRANTIES, INCLUDING, BUT NOT LIMITED TO, THE IMPLIED WARRANTIES OF MERCHANTABILITY AND FITNESS FOR A PARTICULAR PURPOSE ARE DISCLAIMED. IN NO EVENT SHALL THE REGENTS OR CONTRIBUTORS BE LIABLE FOR ANY DIRECT, INDIRECT, INCIDENTAL, SPECIAL, EXEMPLARY, OR CONSEQUENTIAL DAMAGES (INCLUDING, BUT NOT LIMITED TO, PROCUREMENT OF SUBSTITUTE GOODS OR SERVICES; LOSS OF USE, DATA, OR PROFITS; OR BUSINESS INTERRUPTION) HOWEVER CAUSED AND ON ANY THEORY OF LIABILITY, WHETHER IN CONTRACT, STRICT LIABILITY, OR TORT (INCLUDING NEGLIGENCE OR OTHERWISE) ARISING IN ANY WAY OUT OF THE USE OF THIS SOFTWARE, EVEN IF ADVISED OF THE POSSIBILITY OF SUCH DAMAGE.

(33) - Daniel Eischen (targets using libc/posix)

Copyright (c) 2001 Daniel Eischen <deischen@FreeBSD.org>.

All rights reserved.

Redistribution and use in source and binary forms, with or without modification, are permitted provided that the following conditions are met:

1. Redistributions of source code must retain the above copyright notice, this list of conditions and the following disclaimer.

2. Redistributions in binary form must reproduce the above copyright notice, this list of conditions and the following disclaimer in the documentation and/or other materials provided with the distribution.

THIS SOFTWARE IS PROVIDED BY THE AUTHOR AND CONTRIBUTORS "AS IS" AND ANY EXPRESS OR IMPLIED WARRANTIES, INCLUDING, BUT NOT LIMITED TO, THE IMPLIED WARRANTIES OF MERCHANTABILITY AND FITNESS FOR A PARTICULAR PURPOSE ARE DISCLAIMED. IN NO EVENT SHALL THE REGENTS OR CONTRIBUTORS BE LIABLE FOR ANY DIRECT, INDIRECT, INCIDENTAL, SPECIAL, EXEMPLARY, OR CONSEQUENTIAL DAMAGES (INCLUDING, BUT NOT LIMITED TO, PROCUREMENT OF SUBSTITUTE GOODS OR SERVICES; LOSS OF USE, DATA, OR PROFITS; OR BUSINESS INTERRUPTION) HOWEVER CAUSED AND ON ANY THEORY OF LIABILITY, WHETHER IN CONTRACT, STRICT LIABILITY, OR TORT (INCLUDING NEGLIGENCE OR OTHERWISE) ARISING IN ANY WAY OUT OF THE USE OF THIS SOFTWARE, EVEN IF ADVISED OF THE POSSIBILITY OF SUCH DAMAGE.

(35) - ARM Ltd (arm and thumb variant targets only)

Copyright (c) 2009 ARM Ltd

All rights reserved.



Redistribution and use in source and binary forms, with or without modification, are permitted provided that the following conditions are met:

1. Redistributions of source code must retain the above copyright notice, this list of conditions and the following disclaimer.
2. Redistributions in binary form must reproduce the above copyright notice, this list of conditions and the following disclaimer in the documentation and/or other materials provided with the distribution.
3. The name of the company may not be used to endorse or promote products derived from this software without specific prior written permission.

THIS SOFTWARE IS PROVIDED BY ARM LTD "AS IS" AND ANY EXPRESS OR IMPLIED WARRANTIES, INCLUDING, BUT NOT LIMITED TO, THE IMPLIED WARRANTIES OF MERCHANTABILITY AND FITNESS FOR A PARTICULAR PURPOSE ARE DISCLAIMED. IN NO EVENT SHALL ARM LTD BE LIABLE FOR ANY DIRECT, INDIRECT, INCIDENTAL, SPECIAL, EXEMPLARY, OR CONSEQUENTIAL DAMAGES (INCLUDING, BUT NOT LIMITED TO, PROCUREMENT OF SUBSTITUTE GOODS OR SERVICES; LOSS OF USE, DATA, OR PROFITS; OR BUSINESS INTERRUPTION) HOWEVER CAUSED AND ON ANY THEORY OF LIABILITY, WHETHER IN CONTRACT, STRICT LIABILITY, OR TORT (INCLUDING NEGLIGENCE OR OTHERWISE) ARISING IN ANY WAY OUT OF THE USE OF THIS SOFTWARE, EVEN IF ADVISED OF THE POSSIBILITY OF SUCH DAMAGE.

(36) - CodeSourcery, Inc.

Copyright (c) 2009 CodeSourcery, Inc.

All rights reserved.

Redistribution and use in source and binary forms, with or without modification, are permitted provided that the following conditions are met:

- \* Redistributions of source code must retain the above copyright notice, this list of conditions and the following disclaimer.
- \* Redistributions in binary form must reproduce the above copyright notice, this list of conditions and the following disclaimer in the documentation and/or other materials provided with the distribution.
- \* Neither the name of CodeSourcery nor the names of its contributors may be used to endorse or promote products derived from this software without specific prior written permission.

THIS SOFTWARE IS PROVIDED BY CODESOURCERY, INC. "AS IS" AND ANY EXPRESS OR IMPLIED WARRANTIES, INCLUDING, BUT NOT LIMITED TO, THE IMPLIED WARRANTIES OF MERCHANTABILITY AND FITNESS FOR A PARTICULAR PURPOSE ARE DISCLAIMED. IN NO EVENT SHALL CODESOURCERY BE LIABLE FOR ANY DIRECT, INDIRECT, INCIDENTAL, SPECIAL, EXEMPLARY, OR CONSEQUENTIAL DAMAGES (INCLUDING, BUT NOT LIMITED TO, PROCUREMENT OF SUBSTITUTE GOODS OR SERVICES; LOSS OF USE, DATA, OR PROFITS;

OR BUSINESS INTERRUPTION) HOWEVER CAUSED AND ON ANY THEORY OF LIABILITY, WHETHER IN CONTRACT, STRICT LIABILITY, OR TORT (INCLUDING NEGLIGENCE OR OTHERWISE) ARISING IN ANY WAY OUT OF THE USE OF THIS SOFTWARE, EVEN IF ADVISED OF THE POSSIBILITY OF SUCH DAMAGE.

(37) MIPS Technologies, Inc

/\*

\* Copyright (c) 2009 MIPS Technologies, Inc.

\* All rights reserved.

\* Redistribution and use in source and binary forms, with or without modification, are permitted provided that the following conditions are met:

\* \* Redistributions of source code must retain the above copyright notice, this list of conditions and the following disclaimer.

\* \* Redistributions in binary form must reproduce the above copyright notice, this list of conditions and the following disclaimer in the documentation and/or other materials provided with the distribution.

\* \* Neither the name of MIPS Technologies Inc. nor the names of its contributors may be used to endorse or promote products derived from this software without specific prior written permission.

\* THIS SOFTWARE IS PROVIDED BY THE COPYRIGHT HOLDERS AND CONTRIBUTORS "AS IS" AND ANY EXPRESS OR IMPLIED WARRANTIES, INCLUDING, BUT NOT LIMITED TO, THE IMPLIED WARRANTIES OF MERCHANTABILITY AND FITNESS FOR A PARTICULAR PURPOSE ARE DISCLAIMED. IN NO EVENT SHALL THE COPYRIGHT OWNER OR CONTRIBUTORS BE LIABLE FOR ANY DIRECT, INDIRECT, INCIDENTAL, SPECIAL, EXEMPLARY, OR CONSEQUENTIAL DAMAGES (INCLUDING, BUT NOT LIMITED TO, PROCUREMENT OF SUBSTITUTE GOODS OR SERVICES; LOSS OF USE, DATA, OR PROFITS; OR BUSINESS INTERRUPTION) HOWEVER CAUSED AND ON ANY THEORY OF LIABILITY, WHETHER IN CONTRACT, STRICT LIABILITY, OR TORT (INCLUDING NEGLIGENCE OR OTHERWISE) ARISING IN ANY WAY OUT OF THE USE OF THIS SOFTWARE, EVEN IF ADVISED OF THE POSSIBILITY OF SUCH DAMAGE.

\*/

### **MIT License**

This projector product includes the open source software program which applies the terms and conditions provided by owner of the copyright to the "MIT License".

The "MIT License" are WITHOUT ANY WARRANTY; without even the implied warranty of MERCHANTABILITY AND FITNESS FOR A PARTICULAR PURPOSE.

List of MIT License programs

- jquery-1.11.2
- jquery-mobile-1.4.5

License terms of conditions of each program which are provided by owner of the copyright to the "MIT License" are as follows.

Copyright (c) 2012 jQuery Foundation and other contributors,

<http://jquery.com/>

Copyright (c) Nicolas Gallagher and Jonathan Neal

Permission is hereby granted, free of charge, to any person obtaining a copy of this software and associated documentation files (the "Software"), to deal in the Software without restriction, including without limitation the rights to use, copy, modify, merge, publish, distribute, sublicense, and/or sell copies of the Software, and to permit persons to whom the Software is furnished to do so, subject to the following conditions:

The above copyright notice and this permission notice shall be included in all copies or substantial portions of the Software.

THE SOFTWARE IS PROVIDED "AS IS", WITHOUT WARRANTY OF ANY KIND, EXPRESS OR IMPLIED, INCLUDING BUT NOT LIMITED TO THE WARRANTIES OF MERCHANTABILITY, FITNESS FOR A PARTICULAR PURPOSE AND NONINFRINGEMENT. IN NO EVENT SHALL THE AUTHORS OR COPYRIGHT HOLDERS BE LIABLE FOR ANY CLAIM, DAMAGES OR OTHER LIABILITY, WHETHER IN AN ACTION OF CONTRACT, TORT OR OTHERWISE, ARISING FROM, OUT OF OR IN CONNECTION WITH THE SOFTWARE OR THE USE OR OTHER DEALINGS IN THE SOFTWARE.

### **TOPPERS/JSP**

This projector product includes the open source software program "TOPPERS/JSP" which applies the terms and conditions provided by owner of the copyright to the "TOPPERS/JSP".

The "TOPPERS/JSP" are WITHOUT ANY WARRANTY; without even the implied warranty of MERCHANTABILITY AND FITNESS FOR A PARTICULAR PURPOSE.

List of TOPPERS/JSP programs

- jsp-1.4.3

License terms of conditions of each program which are provided by owner of the copyright to the "TOPPERS/JSP" are as follows.

TOPPERS/JSP Kernel

Toyohashi Open Platform for Embedded Real-Time Systems/Just Standard Profile Kernel

Copyright (C) 2000-2003 by Embedded and Real-Time Systems Laboratory Toyohashi Univ. of Technology, JAPAN

Copyright (C) 2004 by Embedded and Real-Time Systems Laboratory Graduate School of Information Science, Nagoya Univ., JAPAN.

The above copyright holder, limited to cases in which one satisfies conditions (1) ~ (4) below, or the conditions described in Version 2 of the GNU Public License officially announced by the Free Software Foundation, consents to the use, reproduction, alteration, and redistribution (hereafter called utilization) of this software (this software includes alterations, likewise below) without compensation.

(1) When this software is utilized in the form of source code, the above copyright declaration, these conditions of utilization, and the following stipulation of no guarantee shall be included in unchanged form inside the source code.

(2) When this software is redistributed in a form in which it can be used in the development of other software, library form, etc., the above copyright display, these terms of utilization, and the following stipulation of no guarantee shall be inserted in documentation accompanying redistribution (user's manual, etc.).

(3) When this software is redistributed in a form in which it cannot be used in the development of other software, embedded in devices, etc., one of the following conditions shall be satisfied.

(a) The above copyright display, these terms of utilization, and the following stipulation of no guarantee shall be inserted in documentation accompanying redistribution (user's manual, etc.).

(b) The TOPPERS Project shall be notified owing to a method in which the form of distribution is decided otherwise.

(4) The above copyright holder and the TOPPERS Project shall be exempt from responsibility for whatever damages occur either directly or indirectly through the utilization of this software.

This software is something that is provided with no guarantee. The above copyright holder and the TOPPERS Project make no guarantee whatsoever in regard to this software, including the possibility of its application. In addition, the above copyright holder and the TOPPERS Project shall also not bear responsibility for whatever damages occur either directly or indirectly through the utilization of this software.

Note: The TOPPERS License has been revised several times; what is shown above is the latest version that is to be applied to software made public hereafter.

## **TINET**

This projector product includes the open source software program "TINET" which applies the terms and conditions provided by owner of the copyright to the "TINET".

The "TINET" are WITHOUT ANY WARRANTY; without even the implied warranty of MERCHANTABILITY AND FITNESS FOR A PARTICULAR PURPOSE.

List of TINET programs

- tinet-1.4.4

License terms of conditions of each program which are provided by owner of the copyright to the "TINET" are as follows.

(1) FreeBSD

Copyright (c) 1980, 1986, 1993

The Regents of the University of California. All rights reserved.

Redistribution and use in source and binary forms, with or without modification, are permitted provided that the following conditions are met:

1. Redistributions of source code must retain the above copyright notice, this list of conditions and the following disclaimer.
2. Redistributions in binary form must reproduce the above copyright notice, this list of conditions and the following disclaimer in the documentation and/or other materials provided with the distribution.
3. All advertising materials mentioning features or use of this software must display the following acknowledgement:

This product includes software developed by the University of California, Berkeley and its contributors.

4. Neither the name of the University nor the names of its contributors may be used to endorse or promote products derived from this software without specific prior written permission.

THIS SOFTWARE IS PROVIDED BY THE REGENTS AND CONTRIBUTORS "AS IS" AND ANY EXPRESS OR IMPLIED WARRANTIES, INCLUDING, BUT NOT LIMITED TO, THE IMPLIED WARRANTIES OF MERCHANTABILITY AND FITNESS FOR A PARTICULAR PURPOSE ARE DISCLAIMED. IN NO EVENT SHALL THE REGENTS OR CONTRIBUTORS BE LIABLE FOR ANY DIRECT, INDIRECT, INCIDENTAL, SPECIAL, EXEMPLARY, OR CONSEQUENTIAL DAMAGES (INCLUDING, BUT NOT LIMITED TO, PROCUREMENT OF SUBSTITUTE GOODS OR SERVICES; LOSS OF USE, DATA, OR PROFITS; OR BUSINESS INTERRUPTION) HOWEVER CAUSED AND ON ANY THEORY OF LIABILITY, WHETHER IN CONTRACT, STRICT LIABILITY, OR TORT (INCLUDING NEGLIGENCE OR OTHERWISE) ARISING IN ANY WAY OUT OF THE USE OF THIS SOFTWARE, EVEN IF ADVISED OF THE POSSIBILITY OF SUCH DAMAGE.

(6) TINET and TOPPERS

TINET (TCP/IP Protocol Stack)

Copyright (C) 2001-2006 by Dep. of Computer Science and Engineering Tomakomai National College of Technology, JAPAN

The above copyright holder, limited to cases in which one satisfies conditions (1) ~ (4) below, or the conditions described in Version 2 of the GNU Public License officially announced by the Free Software Foundation, consents to the use, reproduction, alteration, and redistribution (hereafter called utilization) of this software (this software includes alterations, likewise below) without compensation.

(1) When this software is utilized in the form of source code, the above copyright declaration, these conditions of utilization, and the following stipulation of no guarantee shall be included in unchanged form inside the source code.

(2) When this software is redistributed in a form in which it can be used in the development of other software, library form, etc., the above copyright display, these terms of utilization, and the following stipulation of no guarantee shall be inserted in documentation accompanying redistribution (user's manual, etc.).

(3) When this software is redistributed in a form in which it cannot be used in the development of other software, embedded in devices, etc., following conditions shall be satisfied.

(a) The above copyright display, these terms of utilization, and the following stipulation of no guarantee shall be inserted in documentation accompanying redistribution (user's manual, etc.).

(4) The above copyright holder and the TOPPERS Project shall be exempt from responsibility for whatever damages occur either directly or indirectly through the utilization of this software.

This software is something that is provided with no guarantee. The above copyright holder and the TOPPERS Project make no guarantee whatsoever in regard to this software, including the possibility of its application. In addition, the above copyright holder and the TOPPERS Project shall also not bear responsibility for whatever damages occur either directly or indirectly through the utilization of this software.

### **WPA Supplicant**

This projector product includes the open source software program which applies the terms and conditions provided by owner of the copyright to the "WPA Supplicant".

The "WPA Supplicant" are WITHOUT ANY WARRANTY; without even the implied warranty of MERCHANTABILITY AND FITNESS FOR A PARTICULAR PURPOSE.

List of WPA Supplicant programs

- wpa\_supplicant-2.3

License terms of conditions of each program which are provided by owner of the copyright to the "WPA Supplicant" are as follows.

Copyright (c) 2003-2014, Jouni Malinen <j@w1.fi> and contributors

All Rights Reserved.

This program is licensed under the BSD license (the one with advertisement clause removed).

If you are submitting changes to the project, please see CONTRIBUTIONS file for more instructions.

License

-----

This software may be distributed, used, and modified under the terms of BSD license:

Redistribution and use in source and binary forms, with or without modification, are permitted provided that the following conditions are met:

1. Redistributions of source code must retain the above copyright notice, this list of conditions and the following disclaimer.
2. Redistributions in binary form must reproduce the above copyright notice, this list of conditions and the following disclaimer in the documentation and/or other materials provided with the distribution.
3. Neither the name(s) of the above-listed copyright holder(s) nor the names of its contributors may be used to endorse or promote products derived from this software without specific prior written permission.

THIS SOFTWARE IS PROVIDED BY THE COPYRIGHT HOLDERS AND CONTRIBUTORS "AS IS" AND ANY EXPRESS OR IMPLIED WARRANTIES, INCLUDING, BUT NOT LIMITED TO, THE IMPLIED WARRANTIES OF MERCHANTABILITY AND FITNESS FOR A PARTICULAR PURPOSE ARE DISCLAIMED. IN NO EVENT SHALL THE COPYRIGHT OWNER OR CONTRIBUTORS BE LIABLE FOR ANY DIRECT, INDIRECT, INCIDENTAL, SPECIAL, EXEMPLARY, OR CONSEQUENTIAL DAMAGES (INCLUDING, BUT NOT LIMITED TO, PROCUREMENT OF SUBSTITUTE GOODS OR SERVICES; LOSS OF USE, DATA, OR PROFITS; OR BUSINESS INTERRUPTION) HOWEVER CAUSED AND ON ANY THEORY OF LIABILITY, WHETHER IN CONTRACT, STRICT LIABILITY, OR TORT (INCLUDING NEGLIGENCE OR OTHERWISE) ARISING IN ANY WAY OUT OF THE USE OF THIS SOFTWARE, EVEN IF ADVISED OF THE POSSIBILITY OF SUCH DAMAGE.

### **lighttpd**

This projector product includes the open source software program "lighttpd" which applies the terms and conditions provided by owner of the copyright to the "lighttpd".

The "lighttpd" are WITHOUT ANY WARRANTY; without even the implied warranty of MERCHANTABILITY AND FITNESS FOR A PARTICULAR PURPOSE.

List of lighttpd programs

- lighttpd-1.4.35

License terms of conditions of each program which are provided by owner of the copyright to the "lighttpd" are as follows.

Copyright (c) 2004, Jan Kneschke, incremental

All rights reserved.

Redistribution and use in source and binary forms, with or without modification, are permitted provided that the following conditions are met:

- Redistributions of source code must retain the above copyright notice, this list of conditions and the following disclaimer.
- Redistributions in binary form must reproduce the above copyright notice, this list of conditions and the following disclaimer in the documentation and/or other materials provided with the distribution.
- Neither the name of the 'incremental' nor the names of its contributors may be used to endorse or promote products derived from this software without specific prior written permission.

THIS SOFTWARE IS PROVIDED BY THE COPYRIGHT HOLDERS AND CONTRIBUTORS "AS IS" AND ANY EXPRESS OR IMPLIED WARRANTIES, INCLUDING, BUT NOT LIMITED TO, THE IMPLIED WARRANTIES OF MERCHANTABILITY AND FITNESS FOR A PARTICULAR PURPOSE ARE DISCLAIMED. IN NO EVENT SHALL THE COPYRIGHT OWNER OR CONTRIBUTORS BE LIABLE FOR ANY DIRECT, INDIRECT, INCIDENTAL, SPECIAL, EXEMPLARY, OR CONSEQUENTIAL DAMAGES (INCLUDING, BUT NOT LIMITED TO, PROCUREMENT OF SUBSTITUTE GOODS OR SERVICES; LOSS OF USE, DATA, OR PROFITS; OR BUSINESS INTERRUPTION) HOWEVER CAUSED AND ON ANY THEORY OF LIABILITY, WHETHER IN CONTRACT, STRICT LIABILITY, OR TORT (INCLUDING NEGLIGENCE OR OTHERWISE) ARISING IN ANY WAY OUT OF THE USE OF THIS SOFTWARE, EVEN IF ADVISED OF THE POSSIBILITY OF SUCH DAMAGE

## **PCRE**

This projector product includes the open source software program "PCRE" which applies the terms and conditions provided by owner of the copyright to the "PCRE".

The "PCRE" are WITHOUT ANY WARRANTY; without even the implied warranty of MERCHANTABILITY AND FITNESS FOR A PARTICULAR PURPOSE.

List of PCRE programs

- pcre-8.32

License terms of conditions of each program which are provided by owner of the copyright to the "PCRE" are as follows.

## **PCRE LICENCE**

-----

PCRE is a library of functions to support regular expressions whose syntax and semantics are as close as possible to those of the Perl 5 language.



Release 8 of PCRE is distributed under the terms of the "BSD" licence, as specified below. The documentation for PCRE, supplied in the "doc" directory, is distributed under the same terms as the software itself.

The basic library functions are written in C and are freestanding. Also included in the distribution is a set of C++ wrapper functions, and a just-in-time compiler that can be used to optimize pattern matching. These are both optional features that can be omitted when the library is built.

## **THE BASIC LIBRARY FUNCTIONS**

-----

Written by: Philip Hazel

Email local part: ph10

Email domain: cam.ac.uk

University of Cambridge Computing Service, Cambridge, England.

Copyright (c) 1997-2012 University of Cambridge

All rights reserved.

## **PCRE JUST-IN-TIME COMPILATION SUPPORT**

-----

Written by: Zoltan Herczeg

Email local part: hzmester

Email domain: freemail.hu

Copyright(c) 2010-2012 Zoltan Herczeg

All rights reserved.

## **STACK-LESS JUST-IN-TIME COMPILER**

-----

Written by: Zoltan Herczeg

Email local part: hzmester

Email domain: freemail.hu

Copyright(c) 2009-2012 Zoltan Herczeg

All rights reserved.

## **THE C++ WRAPPER FUNCTIONS**

-----

Contributed by: Google Inc.

Copyright (c) 2007-2012, Google Inc.

All rights reserved.

## **THE "BSD" LICENCE**

-----

Redistribution and use in source and binary forms, with or without modification, are permitted provided that the following conditions are met:

\* Redistributions of source code must retain the above copyright notice, this list of conditions and the following disclaimer.

\* Redistributions in binary form must reproduce the above copyright notice, this list of conditions and the following disclaimer in the documentation and/or other materials provided with the distribution.

\* Neither the name of the University of Cambridge nor the name of Google Inc. nor the names of their contributors may be used to endorse or promote products derived from this software without specific prior written permission.

THIS SOFTWARE IS PROVIDED BY THE COPYRIGHT HOLDERS AND CONTRIBUTORS "AS IS" AND ANY EXPRESS OR IMPLIED WARRANTIES, INCLUDING, BUT NOT LIMITED TO, THE IMPLIED WARRANTIES OF MERCHANTABILITY AND FITNESS FOR A PARTICULAR PURPOSE ARE DISCLAIMED. IN NO EVENT SHALL THE COPYRIGHT OWNER OR CONTRIBUTORS BE LIABLE FOR ANY DIRECT, INDIRECT, INCIDENTAL, SPECIAL, EXEMPLARY, OR CONSEQUENTIAL DAMAGES (INCLUDING, BUT NOT LIMITED TO, PROCUREMENT OF SUBSTITUTE GOODS OR SERVICES; LOSS OF USE, DATA, OR PROFITS; OR BUSINESS INTERRUPTION) HOWEVER CAUSED AND ON ANY THEORY OF LIABILITY, WHETHER IN CONTRACT, STRICT LIABILITY, OR TORT (INCLUDING NEGLIGENCE OR OTHERWISE) ARISING IN ANY WAY OUT OF THE USE OF THIS SOFTWARE, EVEN IF ADVISED OF THE POSSIBILITY OF SUCH DAMAGE.

End

## **FastCGI**

This projector product includes the open source software program "FastCGI" which applies the terms and conditions provided by owner of the copyright to the "FastCGI"

The "FastCGI" are WITHOUT ANY WARRANTY; without even the implied warranty of MERCHANTABILITY AND FITNESS FOR A PARTICULAR PURPOSE.

## List of FastCGI programs

- fcgi-2.4.0

License terms of conditions of each program which are provided by owner of the copyright to the "FastCGI" are as follows.

This FastCGI application library source and object code (the "Software") and its documentation (the "Documentation") are copyrighted by Open Market, Inc ("Open Market"). The following terms apply to all files associated with the Software and Documentation unless explicitly disclaimed in individual files.

Open Market permits you to use, copy, modify, distribute, and license this Software and the Documentation for any purpose, provided that existing copyright notices are retained in all copies and that this notice is included verbatim in any distributions. No written agreement, license, or royalty fee is required for any of the authorized uses. Modifications to this Software and Documentation may be copyrighted by their authors and need not follow the licensing terms described here. If modifications to this Software and Documentation have new licensing terms, the new terms must be clearly indicated on the first page of each file where they apply.

OPEN MARKET MAKES NO EXPRESS OR IMPLIED WARRANTY WITH RESPECT TO THE SOFTWARE OR THE DOCUMENTATION, INCLUDING WITHOUT LIMITATION ANY WARRANTY OF MERCHANTABILITY OR FITNESS FOR A PARTICULAR PURPOSE. IN NO EVENT SHALL OPEN MARKET BE LIABLE TO YOU OR ANY THIRD PARTY FOR ANY DAMAGES ARISING FROM OR RELATING TO THIS SOFTWARE OR THE DOCUMENTATION, INCLUDING, WITHOUT LIMITATION, ANY INDIRECT, SPECIAL OR CONSEQUENTIAL DAMAGES OR SIMILAR DAMAGES, INCLUDING LOST PROFITS OR LOST DATA, EVEN IF OPEN MARKET HAS BEEN ADVISED OF THE POSSIBILITY OF SUCH DAMAGES. THE SOFTWARE AND DOCUMENTATION ARE PROVIDED "AS IS". OPEN MARKET HAS NO LIABILITY IN CONTRACT, TORT, NEGLIGENCE OR OTHERWISE ARISING OUT OF THIS SOFTWARE OR THE DOCUMENTATION.

**Parent topic:** [Notices](#)

## Trademarks

EPSON®, EasyMP®, and PowerLite® are registered trademarks, and EPSON Exceed Your Vision is a registered logomark of Seiko Epson Corporation.

PrivateLine® is a registered trademark and Extra Care<sup>SM</sup> is a service mark of Epson America, Inc.

Mac and OS X are trademarks of Apple Inc., registered in the U.S. and other countries.

Google® is a registered trademark and Android™ is a trademark of Google Inc.

HDMI and High-Definition Multimedia Interface are the trademarks or registered trademarks of HDMI Licensing LLC.  HIGH DEFINITION MULTIMEDIA INTERFACE

General Notice: Other product names used herein are for identification purposes only and may be trademarks of their respective owners. Epson disclaims any and all rights in those marks.



Parent topic: [Notices](#)

## Copyright Notice

All rights reserved. No part of this publication may be reproduced, stored in a retrieval system, or transmitted in any form or by any means, electronic, mechanical, photocopying, recording, or otherwise, without the prior written permission of Seiko Epson Corporation. The information contained herein is designed only for use with this Epson product. Epson is not responsible for any use of this information as applied to other products.

Neither Seiko Epson Corporation nor its affiliates shall be liable to the purchaser of this product or third parties for damages, losses, costs, or expenses incurred by purchaser or third parties as a result of: accident, misuse, or abuse of this product or unauthorized modifications, repairs, or alterations to this product, or (excluding the U.S.) failure to strictly comply with Seiko Epson Corporation's operating and maintenance instructions.

Seiko Epson Corporation shall not be liable for any damages or problems arising from the use of any options or any consumable products other than those designated as Original Epson Products or Epson Approved Products by Seiko Epson Corporation.

This information is subject to change without notice.

[A Note Concerning Responsible Use of Copyrighted Materials](#)

[Copyright Attribution](#)

Parent topic: [Notices](#)

## A Note Concerning Responsible Use of Copyrighted Materials

Epson encourages each user to be responsible and respectful of the copyright laws when using any Epson product. While some countries' laws permit limited copying or reuse of copyrighted material in certain circumstances, those circumstances may not be as broad as some people assume. Contact your legal advisor for any questions regarding copyright law.

Parent topic: [Copyright Notice](#)

## Copyright Attribution

© 2016 Epson America, Inc.

8/16

CPD-51749R1

**Parent topic:** [Copyright Notice](#)