

Phantom Camera Hardware User Manual

Vision Research

Thursday, February 08, 2018

Table of Contents

Part I	Legends	10
Part II	Accessories, Peripherals, and Miscellaneous Features	12
1	Automatic Shutter Lens Mount Installation.....	12
2	Battery Installation for Phantom Miro1, Miro2, and Miro4.....	15
3	C-Mount Lens Adapter Installation.....	16
4	D-Link DSM-604H Ethernet Hard-Drive Setup Process.....	16
5	Multi-IOIOx Unit (Junction Box) Operating Instructions.....	19
6	National Instruments USB X or M Series Data Acquisition Installation.....	23
7	NDIS 6 (10G) Driver Installation.....	26
8	Phantom 10Gb Ethernet Installation.....	27
9	Restore v6.2e Camera to Factory Calibration Settings.....	29
10	SAM-3 (Signal Acquisition Module) Installation.....	30
11	Sensor and Lens Cleaning.....	39
12	Sync Imaging (Camera Network Options).....	40
13	Use in PIV (Particle Imaging Velocimetry) Applications.....	43
Part III	Back Focus Adjustments	46
1	Phantom 65 , Phantom HD, Phantom Flex, Phantom Flex4K.....	46
2	Phantom v-Series.....	47
3	Phantom Miro Series.....	49
Part IV	Connectors, On-Camera Control, and Indicators	52
1	Current Cameras.....	52
	Phantom Flex Series	52
	Phantom Flex4K /Flex4K-GS.....	52
	Phantom Flex.....	53
	Phantom UHS Series	54
	Phantom UHS v2640.....	54
	Phantom UHS xx12 Series.....	55
	Phantom UHS xx11 Series.....	56
	Phantom VEO Series	57
	Phantom VEO / VEO4K L Series.....	57
	Phantom VEO / VEO4K S / VEO4K-PL Series.....	57
	Phantom v-Series	58
	Phantom Miro M / R / LC Series	59
	Phantom Miro LAB Series	60
	Phantom Miro C / N Series	61
	Phantom Miro C110.....	61
	Phantom Miro C210.....	62

	Phantom Miro C210J.....	62
	Phantom Miro N5 and N-JB (Junction Box).....	63
	Phantom Miro eX4	63
2	Discontinued Cameras.....	64
	Phantom 65	64
	Phantom UHS xx10 Series	64
	Phantom Vx11 Series	66
	Phantom Legacy v-Series	67
	Phantom v7.3	67
	Phantom ir300	67
	Phantom Miro Airborne Series	68
	Phantom Miro eX3	69
	Phantom Miro 3	69
3	Obsolete Cameras.....	70
	Phantom HD Series	70
	Phantom v640	71
	Phantom Vx10 Series	71
	Phantom Legacy Series	72
	Phantom v12.1.....	72
	Phantom v12.0.....	73
	Phantom v10.....	73
	Phantom v9.1.....	74
	Phantom v9.0.....	75
	Phantom v7.2.....	75
	Phantom v7.1.....	76
	Phantom v7.0g.....	76
	Phantom v6.2e.....	77
	Phantom v6.1.....	77
	Phantom v6.0.....	78
	Phantom v5.2.....	78
	Phantom v5.1.....	79
	Phantom v5.0.....	79
	Phantom v4.3.....	80
	Phantom v4.2.....	80
	Phantom v4.1.....	80
	Phantom Miro eX Series	81
	Phantom Miro Series	82
	Phantom Miro 4.....	82
	Phantom Miro 2.....	82
	Phantom Miro 1.....	83
4	Peripherals	83
	Phantom Break Out Box	83
	Phantom Miro Mini Break Out Box	84
	Phantom Miro Junction Box	84
	Phantom CineMag IV	85
	Phantom CineMag II	85
	Phantom CineMag I	85
	Phantom CineStation IV	86
	Phantom 10G CineStation	86
	Phantom 1G CineStation	87
	Phantom Remote Control Unit	87
5	Phantom On-Camera Control Buttons.....	88
	Current Cameras	88

Phantom Flex Series.....	88
Phantom Flex4K / Flex4K-GS.....	88
Phantom Flex	90
Phantom UHS Series.....	91
Phantom UHS v2640.....	91
Phantom UHS xx12 Series.....	92
Phantom UHS xx11 Series.....	92
Phantom v-Series.....	93
Phantom Miro LAB Series.....	95
Phantom VEO S Series.....	95
Phantom Miro M / R / LC Series.....	96
Phantom Miro eX4.....	97
Discontinued Cameras	97
Phantom 65.....	97
Phantom HD Series.....	98
Phantom UHS xx10 Series.....	99
Phantom Vx11 Series.....	100
Phantom Miro eX Series.....	101
Obsolete Cameras	102
Phantom Miro 4.....	102
Phantom Miro 2.....	102
Phantom Miro 1.....	102
Peripherals	102
Phantom RCU (Remote Control Unit).....	102
6 Connector Descriptions.....	103
Phantom 10/100 Ethernet Connector (6-Pin Female)	103
Phantom 10G Connector (RJ-45)	103
Phantom +12VDC (Aux)	104
Phantom Auxiliary Connector (4-Pin Female)	104
Phantom Breakout Box Connectors	104
Phantom Capture Connector (8-Pin Male)	107
Phantom Capture Connector (Revision 4) (19-Pin Male)	108
Phantom Capture Connector (Revision 3) (19-Pin Female)	110
Phantom Capture Connector (Revision 2) (19-Pin Male)	113
Phantom Capture Connector (Revision 1) (19-Pin Male)	116
Phantom CineStation 10G Fiber Optic Connector (SC)	121
Phantom CineStation Console Connector (RJ-45)	121
Phantom CineStation Ethernet Connector (RJ-45)	121
Phantom CineStation HD-SDI Connectors (BNC)	122
Phantom F-SYNC Connector (BNC)	122
Phantom GenLock Connector (BNC)	122
Phantom Gigabit Ethernet Connector (RJ45)	123
Phantom Gigabit Ethernet Connector (Revision 3) (8-Pin Male)	123
Phantom Gigabit Ethernet Connector (Revision 2) (8-Pin Male)	123
Phantom Gigabit Ethernet Connector (Revision 1) (6-Pin Male)	124
Phantom GPS Connector	124
Phantom HD-SDI Connector (BNC)	125
Phantom 3G HD-SDI (BNC)	125
Phantom IEEE 1394 Connector (6-Pin Female)	125
Phantom IEEE 1394 Daisy Chain Connector	126
Phantom IOIOI Connector (10-Pin Male)	126
Phantom Miro 10/100 Ethernet Connector (8-Pin Female)	127
Phantom Miro CompactFlash® Slot	127
Phantom Miro 1 Capture Connector (12-Pin Male)	128

Phantom Miro 2 Capture Connector (12-Pin Male)	129
Phantom Miro 4 Capture Connector (12-Pin Male)	130
Phantom Miro eX1 Capture Connector (12-Pin Male)	132
Phantom Miro eX2 Capture Connector (12-Pin Male)	133
Phantom Miro eX4, Miro 3, and Miro Airborne/AirborneHD Capture Connector (12-Pin Male)	134
Phantom Miro M / R / LC Series Capture Connector (12-Pin Male)	136
Phantom Miro C-Series Capture Cable (12-Pin Male)	137
Phantom Miro C110 Gigabit Ethernet Connector (RJ-45)	138
Phantom Miro C110 Trigger, SDI, I/O 1, and I/O 2 Connector (BNC)	139
Phantom Miro C110 Power Connector (3-Pin Male)	139
Phantom Miro C210 Power Connector (6-Pin Male)	139
Phantom Miro C210J Remote Connectors	140
Phantom Miro C210J System Connectors	140
Phantom Miro N5 CoaXPress (CXP) Connector	141
Phantom Miro N-JB CoaXPress (CXP) / SDI Connectors (BNC)	142
Phantom Miro N-JB Remote Connector (6-Pin Fischer)	142
Phantom Miro N-JB System Connector (27-Pin Fischer)	142
Phantom Miro Mini Breakout Box Connectors	143
Phantom Miro Junction Box Connectors	144
Phantom Miro Mx40 Capture Connector (12-Pin Male)	148
Phantom v4.1 Power/Capture Connector (19-Pin Male)	149
Phantom Miro Power Connector (6-Pin Male)	152
Phantom Miro LAB Series BNC Connectors	152
Phantom Miro LAB Series Power Connector (6-Pin Male)	153
Phantom Miro M / R / LC Series Power Connector (Revision 2) (6-Pin Male)	154
Phantom Miro Mx40 Power Connector (6-Pin Male)	154
Phantom OFF / AUTO / ON Toggle Switch	154
Phantom Power Connector (3-Pin Male)	155
Phantom Power Connector (3-Pin Male)	155
Phantom Power Connector (4-Pin Male)	155
Phantom Programmable I/O	156
Phantom Range Data Connector (6-Pin Male)	158
Phantom Range Data Connector (8-Pin Male)	159
Phantom RCU Battery Compartment	159
Phantom RCU Optional Bluetooth	159
Phantom RCU HD-SDI Video-In Connector (BNC)	160
Phantom RCU Power, Control, Analog Video Connector	161
Phantom RCU Type A USB Receptacle	161
Phantom Remote/Range Data Connector (8-Pin Female)	162
Phantom Remote Connector (5-Pin Female)	163
Phantom Return / Genlock (3G HD-SDI)	163
Phantom R/S (Run / Stop) Connector	164
Phantom RTO Fiber Optic Connector	164
Phantom Sync (Capture) Connector	164
Phantom Trigger Connector (BNC)	165
Phantom Timecode Connectors (BNC)	165
Phantom Component ViewFinder	166
Phantom VEO Capture Connector (12-Pin Male)	166
Phantom VEO Power Connector (6-Pin Male)	167
Phantom ViewFinder (3G HD-SDI)	167
Phantom ViewFinder Connector (Revision 2) (7-Pin Female)	167
Phantom ViewFinder Connector (Revision 1) (7-Pin Female)	168
Phantom ViewFinder Power Connector	169
7 Indicators	170

Current Cameras	170
Phantom Flex Series	170
Phantom Flex4K, Flex4K-GS	170
Phantom Flex	171
Phantom UHS Series	171
Phantom UHS v2640	171
Phantom UHS xx12 Series	172
Phantom UHS xx11 Series	173
Phantom v-Series	174
Phantom Miro C Series	174
Phantom Miro C110	174
Phantom Miro C210	175
Phantom Miro C210J	175
Phantom Miro N5 and N-JB (Junction Box)	176
Phantom Miro LAB Series	176
Phantom VEO Series	177
Phantom VEO L Series	177
Phantom VEO S Series	177
Phantom Miro M / R / LC Series	178
Phantom Miro eX4	179
Discontinued Cameras	179
Phantom 65	180
Phantom HD Series	180
Phantom UHS xx10 Series	181
Phantom Vx11 Series	182
Phantom v640	183
Phantom Vx10 Series	183
Phantom Legacy v-Series	184
Phantom v12.1	185
Phantom v10	185
Phantom v9.1	186
Phantom v7.3	187
Phantom ir300	187
Phantom Miro Airborne Series	188
Phantom Miro eX Series	189
Phantom Miro 3	190
Obsolete Cameras	191
Phantom v12.0	191
Phantom v9.0	192
Phantom v7.2	193
Phantom v7.1	193
Phantom v7.0g	194
Phantom v6.2e	195
Phantom v6.1	195
Phantom v6.0	196
Phantom v5.2	197
Phantom v5.1	198
Phantom v5.0	199
Phantom v4.3	199
Phantom v4.2	200
Phantom v4.1	201
Phantom Miro 4	201
Phantom Miro 2	202
Phantom Miro 1	203

Peripherals	204
Phantom CineMag IV	204
Phantom CineMag I & II	204
Phantom CineStation IV	205
Phantom RCU (Remote Control Unit)	205
Part V Phantom CineFlash - Help	208
1 Installing the Phantom CineFlash Docking Station	208
2 Editing and Saving a Cine to the Phantom CineFlash	209
3 Reviewing a Saved Cine File on a Phantom CineFlash	211
4 Erasing a Saved Cine File on a Phantom CineFlash	212
Part VI Phantom CineMag - Help	214
1 Defining the Operational Mode	214
2 Recording to a Phantom CineMag	216
3 Viewing a Cine File Stored in Phantom CineMag	221
4 Editing a Cine File Stored in Phantom CineMag	222
5 Erasing Files from the Phantom CineMag	224
Part VII Service & Support	226
1 Vision Research Worldwide Service Network	227
2 Phantom Certification Program	229

Part



1 Legends



WARNING



CAUTION



NOTE



TECH TIP

Part



2 Accessories, Peripherals, and Miscellaneous Features

Vision Research supports a variety of peripheral devices and third party products and feature sets that can be used in conjunction with the Phantom cameras. This module describes how to set up and install many of these devices and products.

2.1 Automatic Shutter Lens Mount Installation

Kit Contents

- One (1) - Automatic Shutter Lens Mount (Part Number: VRI-EXTSHUTTER-F-MOUNT)
- One (1) - Automatic Shutter Lens Mount compatible break-out box (Part Number: VRI-BOB-2-MS)
- One (1) - Installation Kit, (Part Number: AD-VSHUTTER-INSTALL-KIT), containing the following shims sizes:
 - 0.5mil
 - 1mil
 - 2mil
 - 3mil
 - 4mil
 - 5mil
 - 10mil
- CD containing latest firmware and software
- 7/64 inch hex wrench
- 9/64 inch hex wrench
- Four 8-32 x 5/16" cap head screws
- Four 6-32 x 5/16" cap head screws

Equipment Needed

- Standard Non-Zoom Nikon Lens
- Focus Target (i.e., some type of test chart)

Minimum Firmware/Software Requirements



The supplied CD contains the most current Firmware, FPGA and Phantom Camera Control Software files.

STEP-BY-STEP PROCEDURE

Verify Camera Meets Minimum Firmware Requirements

1. Install the Phantom Camera Control Application, from the disc provided by double clicking on the Autorun.exe file.
 - a. When the installer screen appears, select Install Phantom (*version number*), and follow the instructions.
 - b. After installation is complete, select Run Phantom (*version number*) on the install screen.

2. From the Windows desktop double-click the Phantom Camera Control icon.
 - a. From the Phantom Camera Control – Main Screen:
 - 1) Click on the Camera pull-down menu, then
 - 2) Select the Properties command.
3. In the Properties dialogue window verify that the camera meets the minimum Firmware, and FPGA, requirements:
 - a. If the firmware meets the minimum requirements skip to Step C.
 - b. If the firmware does not meet the minimum requirements continue.

Perform a Firmware Upgrade



Ensure the camera is connected to AC power. If the firmware upgrade fails, the camera will need to be returned to Vision Research for service.

1. Create and copy the firmware files from the CD to a directory, (i.e., C:\Phantom Firmware).
2. Note the serial number of the camera the firmware upgrade is to be performed on. The four-digit serial number is located on the side of the camera.
3. From the Tools pull-down menu, select the Firmware control (Nucleus) command. The Camera Repair and Firmware Upgrade (Nucleus) application opens.
4. In the Camera Repair and Firmware Upgrade (Nucleus) dialogue window:
 - a. Click the down-arrow next to the Camera field and select the camera the firmware upgrade is to be performed on.
 - b. Select the appropriate method to perform the File to Upload selection:
 - 1) Click on Firmware... (ph7 file).
 - a) Browse the provided CD or navigate to the directory, (folder), created in Step 1 of Performing a Firmware Upgrade containing the ph7file.
 - b) Select the ph7 file, then
 - c) Click the Open button.
 - 2) Click on FPGA... (ph.bin file).
 - a) Browse the provided CD or navigate to the directory, (folder), created in Step 1 of Performing a Firmware Upgrade containing the ph.bin file.
 - b) Select the ph.bin file for your camera model, then
 - c) Click the Open button.
 - c. Click the Upload.. button.
 - d. Click the OK button when the ' RAM Cines will be deleted' warning message appears.
 - e. Click the OK button in the "Proceed with uploading..." message window. The system will display a series of information windows.
 - f. In the Camera Repair and Firmware Upgrade (Nucleus) window, click the:
 - 1) Refresh button to verify changes, then the
 - 2) Close button.
 - h. Close the Phantom Camera Control application.
 - i. Power off the camera.

Install the Automatic Shutter Lens Mount

1. Remove the lens mount and back focus shims from the camera housing using a 9/64 inch hex wrench.

2. Retain all screws and back focus shims for later use. If needed, extra screws have been included in the kit.
3. Remove all four (4) automatic shutter lens mount housing screws, located in the counter bores of all four corners using a 7/64 hex wrench.
4. Retain all screws for later use. Do not mix with lens mount screws removed in Step 1.
5. Separate the automatic shutter lens mount back plate from the automatic shutter lens mount housing body.
6. Place the original shutter shims, if any, removed in Step 1 on the back side of the automatic shutter lens mount back plate just removed.
7. Carefully insert the automatic shutter lens mount back plate, with the original shims into the lens mount of the camera with the larger size upward.
8. Attach the automatic shutter lens mount back plate, rounded side down, to the camera housing with the four (4) supplied 8-32 x 5/16" long Socket head cap lens mount screws using the 9/64 hex wrench.
9. Re-attach the automatic shutter lens mount housing body to the back plate by re-installing the four (4) automatic shutter lens mount screws removed in Step 3 using the 7/64 hex wrench.
10. Attach the Power/Control cable of the break-out box to the Power/Control Connector located on the side of the automatic shutter lens mount housing.
11. Attach the 19-pin conical connector of the break-out box to the 19-pin Capture interface on the back of the camera, and apply power. The Automatic Shutter Lens Mount will self-test and rotate to the open position.

Test the Automatic Shutter Lens Mount

1. Connect to the camera using the Phantom Camera Control application.
2. From the Live Panel:
 - a. Click the Camera Settings selector, then
 - b. Click on the CSR, (Current Session Reference) button. Shutter wheel should close then re-open and a dialogue box will open asking if you want to 'Save the new calibration to the camera non-volatile memory?'
4. In the 'Save the new calibration to the camera non-volatile memory?' dialogue window, click Yes.

Perform Back Focus Adjustment



The standard shim depth for all v-Series cameras is 7mil. This depth may require minor adjustments to achieve proper back focus. Each camera may vary slightly. Some cameras require no shims. Ensure the lens is set to the widest aperture before proceeding.

1. Attach the lens to the Automatic Shutter Lens Mount.
2. Check infinity focus by focusing far beyond the infinity specification of the applied lens.
 - a. If an object is not sharply focused to infinity:
 - 1) Remove the Automatic Shutter Lens Mount.
 - 2) Remove the installed shim(s).
 - 3) Reinstall the Automatic Shutter Lens Mount making sure that it is securely fastened, then
 - 4) Re-test.
 - b. If the object is not focused at infinity repeat removing shims until focus is achieved.
 - c. If focus is achieved prior to setting to infinity, shims need to be added:
 - 1) Remove the Automatic Shutter Lens Mount.
 - 2) Add various shim sizes until focus is achieved.



The farther the focus point is to the infinity setting the thicker the shim(s) will be.

- d. If the object is in focus, adjust the lens to the shortest focus point and measure the minimum focus distance of the lens to the target using the tape measure.
- e. If not in focus, repeat the Back Focus Adjustment process again.
- f. If focused, adjust the lens to medium focus point, approximately 10 feet from the sensor not the lens, and measure the minimum focus distance of the lens to target using the tape measure.
- g. If not focused repeat the Back Focus Adjustment process again.

Performing a Current Session Reference - Image Calibration

Use Current Session Reference (CSR) to calibrate the image for current acquisition parameters. The application will compute the offsets specific to the current parameters, obtaining a more precise compensation of the pixel errors.

You use a CSR before recording a Cine when you have a single Cine configuration or a MultiCine configuration with all Cine files having the same acquisition parameters. If the Cine files have different setup values, you should perform CSR on each Cine separately.

1. Start the Phantom Control Software application.
2. Click on the Live Panel, then
3. Set the desired settings. The calibration will be done considering the resolution, sample rate, exposure and EDR values. The current settings for AutoExposure and for BitDepth are ignored.
4. Click on the Camera Settings selector, the
5. Click on the CSR, (Current Session Reference) button.
6. In the Current Session Reference message window, click the OK button. The system will now acquire a few images for calibration.



After executing a CSR, if you change the acquisition parameters, the calibration calculated during the Current Session Reference will apply partially correct on the new setup. For example, if you increase later the image resolution the pixels outside the previous resolution used at CSR will be corrected differently.

Vision Research recommends that you perform a CSR prior to any new recording to ensure the best image quality possible.

2.2 Battery Installation for Phantom Miro1, Miro2, and Miro4

1. Remove the battery cover by unscrewing the retaining screw, counter-clockwise, located on the bottom of the camera.



The location of the two battery contacts in the top area of the battery compartment. These contacts are extremely fragile. Great care must be taken, not to damage them during battery installation.

2. Carefully align the battery with the contacts and bumper.
3. While keeping the battery's top edge against the wall of the camera, carefully slide the bottom of the battery into the battery compartment so the battery is upright.
4. Reinstall the batter cover and retaining screw.

2.3 C-Mount Lens Adapter Installation

Kit Contents

- One (1) - C-mount Lens Adapter (Part Number: VRI-MNT-V12-C)

Equipment Needed

- 8/32 inch hex wrench
- 1/16 inch hex wrench
- 1' C-Mount lens
- Tape measure
- Focus Target (i.e., some type of test chart)

STEP-BY-STEP PROCEDURE

1. Remove the four (4) F-mount adapter plate screws using a 8/32 inch hex wrench.
2. Carefully attach the C-mount lens adapter by screwing the adapter clock-wise into the camera housing. The C-Mount adapter should be able to turn inward and outward, to and from, the housing.
3. Tightly attach a lens, (recommended lens are to use a fixed focus 6.5mm or 12.5mm lens), to the camera and set the focus ring to infinity.
4. Using the 1/16 inch hex wrench, loosen the five back focus adjustment screws just enough to permit the C-Mount lens adapter to turn inward and outward to and from the housing.
5. With the camera in Live Preview Mode and an image showing on the monitor aim the camera at a subject at a distance greater than the maximum focus distance printed on the lens you are adjusting for.
 - a. Grasp the lens, being careful not to disturb the focusing ring, and turn the lens mount inward or outward until the image on the monitor is sharp and then continue just past this point of focus until the image goes ever so slightly out of focus again.
 - b. Retighten the back focus adjustment screws and check the focus. When the adjustment is done properly, the lens will focus at a point just before the focusing ring reaches the end of its travel on the infinity end. By turning the focus ring a little more the image will go out of focus thus passing through the infinity adjust point.

2.4 D-Link DSM-604H Ethernet Hard-Drive Setup Process

Phantom cameras can be defined to automatically save recorded Cine file to an Ethernet hard-drive. The information documented below has been written for a D-Link DSM-604H Ethernet Hard-drive. If you intend to utilize another vendor's Ethernet hard-drive, consult the documentation, provided by the manufacture, for the procedure of 'Assigning an IP Address to the Hard-Drive'.



This feature is not supported on Phantom Miro camera models.

STEP-BY-STEP PROCEDURE

Required Equipment

1. DHCP Server
2. Ethernet HUB, or Layer 2 or Layer 3 Switch

3. Web Browser Application
4. Phantom Camera

Assigning an IP Address to the D-Link Ethernet Hard-drive via a DHCP Server

Initially, the D-Link Ethernet Hard-drive requires a DHCP server to assign an IP address to the drive. The user must be familiar with specifying the parameters of the DHCP used to allocate IP addresses.

1. Define the DHCP server to allocate an IP Address the D-Link Ethernet Hard-drive.
2. Connect the DHCP server to an Ethernet hub, Layer 2 or Layer 3 Switch and apply power to both.
3. Connect the D-Link Ethernet drive to the Ethernet hub, Layer 2 or Layer 3 Switch and apply power.
4. Ensure that the LAN and Status LEDs, on the D-Link Ethernet hard-drive are flashing:
 - a. If No, take a paper clip and hold in the reset button, located on the back of the drive, for 2 seconds.
 - b. If Yes, go to next step.

Changing the D-Link Ethernet Hard-drive IP Address for Use w/Phantom Camera

The Ethernet hard-drive must be assigned an IP address with the same network number as the attached Phantom camera. By default Vision Research assigns all of our Phantom cameras to the 100.100.0.0 network with a sub-network mask of 255.255.0.0. The host portion of the Ethernet hard-drive must be a unique identifier, for example, 100.100.100.20, where 100.100 indicates the network identifier of the IP address and 100.20 represents the host identifier of the address.

1. Open a web browser application, such as Microsoft Internet Explorer, Netscape Navigator, FireFox, etc.
2. In the web browsers' Address field enter the <IP Address> or the <Host Name> of the Ethernet drive to access the D-Link Configuration Tool. In this example, we have entered the Host Name of the Ethernet drive <http://DSM-604H>. The D-Link Configuration Tool login window should be displayed in the web browser.

 If you are using another type of Ethernet drive, please refer to the manufactures documentation on 'How to Change the IP Address'.

3. Enter the user name <admin> and leave the password blank. Click on the LAN button from D-Link Configuration Tool.
4. Under the LAN Settings>Home Tab click on the Static IP (Assign a Fixed IP Address) radio button, and enter the new Fixed IP Address and the Subnet mask: i.e., 100.100.100.20 with a subnet of 255.255.0.0
5. Click the Apply button.

 The web browser will display a warning informing the user that the page has timed out. This is normal as the IP Address the browser was connected to, is no longer applicable.

Mapping the D-Link Ethernet Hard-drive for Use by the Phantom Control Unit

Mapping the Ethernet hard-drive in the Phantom Control Unit makes it easier to access the saved files, on the Ethernet hard-drive, later on.

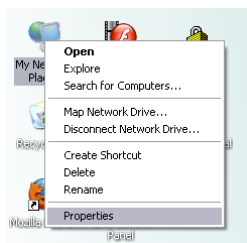

1. Remove the DHCP Server from the Ethernet hub, Layer 2 or Layer 3 Switch and connect the Phantom Control Unit and the Phantom camera to the Ethernet hub, Layer 2 or Layer 3 switch the Ethernet hard-drive is connected to.
2. Ensure that the control unit computer is using a 100.100.0.0 network identifier. This can be accomplished by click the right mouse key on top of the 'My Network Places' on the computer's desktop and selecting the 'Properties' option from

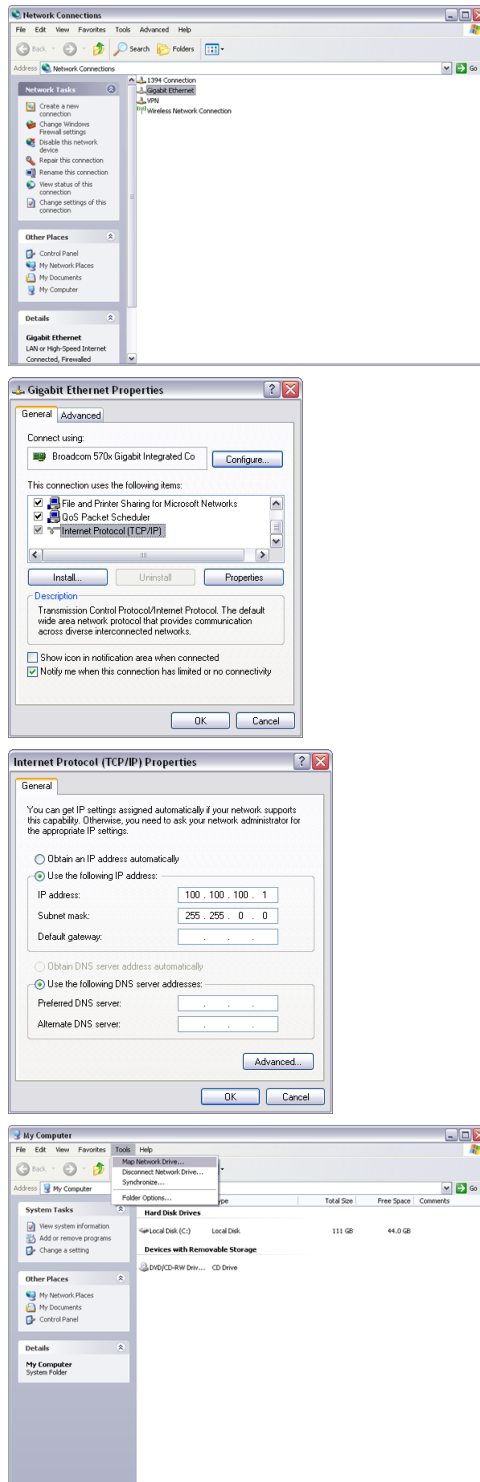

the pop-up window.

3. In the Network Connections window double-click the left mouse key on the LAN adapter connected to the Ethernet hub, Layer2 or Layer 3 Switch.
4. From the Ethernet Properties window double-click the left mouse key on the Internet Protocol (TCP/IP) field.
5. In the Internet Protocol window verify the:
 - a. The Use the following IP address radio button is selected.
 - b. IP Address field indicates that the control unit computer has been assigned to the 100.100.0.0 network.
 - c. Subnet Mask is 255.255.0.0.
6. Close all open windows and return to the computers desktop.
7. Double-click the left mouse key on top of the My Computer icon.
8. In the My Computer window click on the Tool>Map Network Drive command.

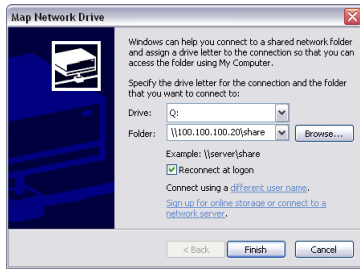

9. In the Map Network Drive dialogue window, the user must select the Drive letter that will be associated with the external hard-drive, and specify the location the files will be written into. The format for this is to enter <\\ip_address of storage device\name of a folder for file storage>.
10. In the example below, we have chosen to map the files to be saved to the <Q:> drive <\\100.100.100.20\share> folder.
11. Enable the Reconnect at login option, in the Map Network Drive dialogue window, and click on the Finish button to activate these parameters

Defining a Phantom Camera to Automatically Save Cine Files to the D-Link Drive via the Phantom (PCC) Camera Control Application

In the example shown the Cine file will automatically be written to //100.100.100.20/share/mymovie.cin.

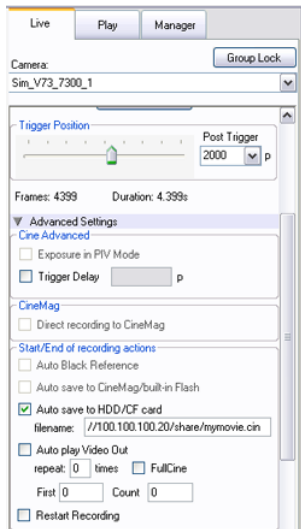

1. Click on the Manager Panel tab.
2. Double-click on the Phantom camera that will be connected to, and save its Cine files to, the external Ethernet hard-drive and click the Select button.
3. Click on the Live Panel tab, then
4. Click on the Advanced Setting selector.
5. Locate the Start/End of recording actions options and enable the Auto save to HDD/CF card option.
6. enter </ip_address of the Ethernet drive/folder files are being stored into/filename of the Cine file being saved> in the Auto Save to HDD/CF card entry field.

2.5 Multi-IOIOx Unit (Junction Box) Operating Instructions

STEP-BY-STEP PROCEDURE

Multi-IOIOG Unit - For Use with Phantom Ethernet Camera Models

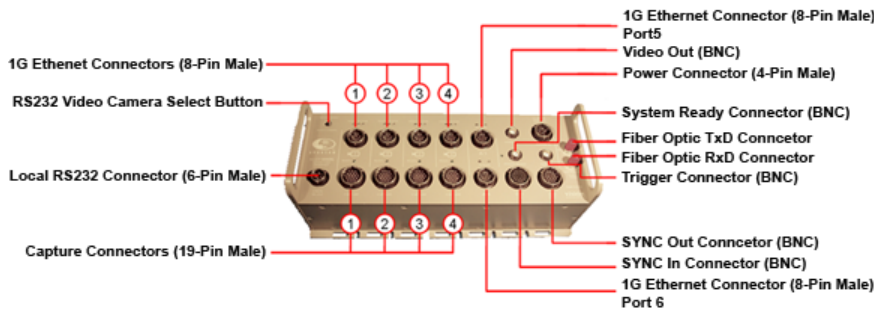

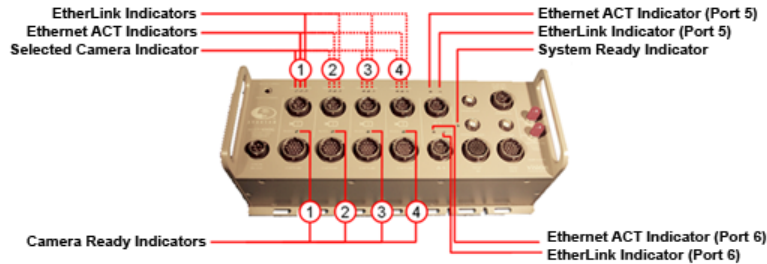

1. Unpack the Multi-IOIOG, the Glass Fiber Optic Cable, Ethernet cables and the Camera's Capture cables.
2. Run known good fiber optic cable from the testing area to the control room.
3. Carefully remove the black protective covers from the SC terminated ends of the fiber optic cable and remove the protective plug on the port on the Gigabit Ethernet switch/HUB.



If fiber optic cables are not being used in the application, do not remove the protective covers from the Multi-IOIOG box. If fiber optic cables were previously attached and have been removed replace the protective covers to avoid damaging the opto-coupler connector.

4. Plug the fiber optic cable end onto the Gigabit Ethernet switch/HUB port. The Switch/Hub end is terminated with SC connector is polarized, and it only plugs in one way.
5. Carefully remove the protective covers from the ST terminated ends of the fiber optic cable as well as the sockets on the Multi-IOIOG and plug the cables into the sockets paying attention to the alignment tabs.
6. Note the orientation of the cables. The cable needs to be crossed over to work. The TX output of one device needs to be connected to the RX of the other. The Multi-IOIOG end is terminated with ST connectors and can be plugged in either way so it is important to observe the notation on each wire.
7. The blue cable should be connected to TX and the orange cable to RX.
8. Apply power to the Ethernet Switch/HUB.
9. Connect the Phantom Control Unit to the Ethernet Switch/HUB with a standard CAT-6 cable.
10. Mount the Multi-IOIOG to the test bed and, using the supplied power wire, connect a fused and switched 24-volt DC power source with the capacity to provide enough current to power all the devices to the Power In socket 2 amps for each V5.1 and V7.1 Camera, 1 amp for each V4.2 Camera, and 2 amp for the Multi-IOIOG.
11. Locate and set up the cameras that will be used for the test.
12. Connect the camera that will be used to synchronize the time to the First channel on the Multi-IOIOG using the 8 pin Ethernet, and 19 pin Capture cables.



This camera will synchronize the time on the other three cameras. It is also the only one you will be able to reset the time on while connected through the Multi-IOIOG. Within the Phantom software Setup and Recording window the time, on cameras 2, 3 and 4, will appear as synchronized IRIG time even though it is time taken from camera.

13. If IRIG time is needed, it can be inserted through a cable connected to the Sync In connector Pins G and H on the Multi-IOIOG. All cameras will then sync to IRIG time and be indicated as such within the Phantom software Setup and Recording window.
14. Connect the other cameras to the Multi-IOIOG with the remaining 8 pin Ethernet cables and 19 pin Capture cables.
15. Apply power to the Multi-IOIOG. The Ready (green) LED will illuminate (approximate delay - 3 minutes). If no camera is connected to a particular capture port that port's Ready LED will be active.

The System Ready (green) LED becomes illuminated once all four capture ports' Ready LEDs become active.

The Video (blue) LED above each of the Ethernet ports indicates that the video out and the RS-232 ports are

connected to the camera. Camera selection can be accomplished by depressing the RS-232/Video Select Camera button located at the top left corner of the panel.

The Act (Activity) and the Lnk (EtherLink) LED indicators, above each of the Ethernet ports are tri-color LEDs indicating the following Ethernet has been detected:

- Orange : 10Mbps
- Red: 100Mbps
- Green: 1000Mbps or 1Gbps



If a camera is not connected to a channel the green Ready LED will light and stay lit even after an event trigger.

15. Apply power to the “Phantom Control Unit” and start the Phantom Camera Control application.
 16. From the Acquisition menu click the Select Camera option to select one of the cameras. The system should now be ready to operate.
 17. Once inside the Phantom software Setup and Recording window you can use the Camera pull down to select and then control each camera.
 18. To set up the cameras focus and exposure remotely, a monitor can be connected to the Video Out BNC connector on the Multi-IOIOG. Use the Select Camera push button to switch the camera to the Video Output.
- Serial Control can also be used through the Multi-IOIOG to select and set internal camera settings. The blue Video LED indicates the channel that is selected.
16. A device to trigger the cameras can be connected to the Trigger BNC connector. This is connected to the External Trigger within the cameras and is used to simultaneously trigger all the cameras at once. The trigger should be a switch closure. This will bring the 5-volt trigger line to ground and store the Cine inside the camera. The System Ready LED will go out and the 5-volt signal on the System Ready BNC will go to ground. These will go back to the “on” state when all the cameras have been put back into the Capture mode. As each camera is switched back into the Capture mode the Ready LED on that channel will light.

Multi-IOIOI Unit - For Use with Phantom IEEE 1394 Camera Models

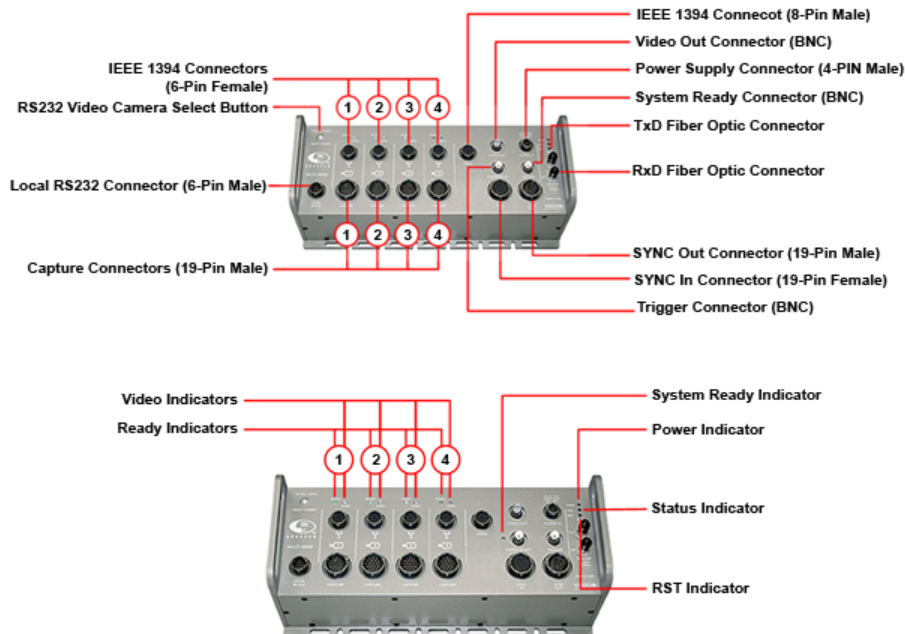

1. Unpack the Multi-IOIOI, the external NEC MX/GF4 Network Adaptor, the Glass Fiber Optic Cable, IEEE-1394 cables and the Camera's Capture cables.
2. Run known good fiber optic cable from the testing area to the control room.
3. Carefully remove the black protective covers from the SC terminated ends of the fiber optic cable and remove the protective plug in the port on the back of the NEC MX/GF4 Network adaptor.



If fiber optic cables are not being used in the application, do not remove the protective covers from the Multi-IOIOI box. If fiber optic cables were previously attached and have been removed replace the protective covers to avoid damaging the opto-coupler connector.

4. Plug the fiber optic cable end into the NEC MX/GF4 Network Adaptor. The Network Adaptor end is terminated with SC connectors is polarized, and it only plugs in one way.
5. Carefully remove the black protective covers from the ST terminated ends of the fiber optic cable as well as the sockets on the Multi-IOIOI and plug the cables into the sockets paying attention to the alignment tabs.
6. Note the orientation of the cables. The cable needs to be crossed over to work. The TX output of one device needs to be connected to the RX of the other. The Multi-IOIOI end is terminated with ST connectors and can be plugged in either way so it is important to observe the notation on each wire.
The blue cable should be connected to TX and the orange cable to RX.
7. Connect the Power Supply cable to the Network Adaptor on the rear of the unit and plug it into the house AC power.
8. Connect the NCC (Laptop) to the NEC MX/GF4 Network Adaptor with a standard 6-pin to 6-pin IEEE-1394 cable.
9. Mount the Multi-IOIOI to the test bed and, using the supplied power wire, connect a fused and switched 24-volt
10. power source with the capacity to provide enough current to power all the devices to the Power In socket 1.2 amps for each V5 and V6 camera, 0.8 amps for each V4 camera and 1 amp for the Multi-IOIOI.
11. Locate and set up the cameras that will be used for the test.
12. Connect the camera that will be used to synchronize the time to the First channel on the Multi-IOIOI using the 6 pin IEEE-1394 and 19 pin Capture cables.



This camera will synchronize the time on the other three cameras. It is also the only one you will be able to reset the time on while connected through the Multi-IOIOI. Within the Phantom software Setup and Recording window the time, on cameras 2, 3 and 4, will appear as synchronized IRIG time even though it is time taken from camera.

13. If IRIG time is needed, it can be inserted through a cable connected to the Sync In connector Pins G and H on the Multi-IOIOI. All cameras will then sync to IRIG time, and be indicated as such within the Phantom software Setup and Recording window.
14. Connect the other cameras to the Multi-IOIOI with the remaining 6 pin IEEE-1394 cables and 19 pin Capture cables.
15. Apply power to the Multi-IOIOI. The orange PWR (Power) LED will light, the multi color STS (IEEE-1394 Status) LED will light and the red RST (Reset) LED will blink on then off.

The STS LED will light up Green if the fiber optic link is connected, on and working. It will be Red if any of the network components are not functioning properly.

One of the blue Video LED's will light and as each camera boots up and the green Ready LED for that channel will light.

When all the connected cameras have initialized, and have been placed into the Capture mode by default, the System Ready LED will light. When the green System Ready LED has lit, the Multi-IOIOI and the Cameras are ready to operate.



If a camera is not connected to a channel the green Ready LED will light and stay lit even after an event trigger.

16. Apply power to the NCC (Laptop) and start the Phantom Camera Control application.
17. From the Acquisition menu click the Select Camera option to select one of the cameras. The system should now be ready to operate.
18. Once inside the Phantom software Setup and Recording window you can use the Camera pull down to select and then control each camera.
19. To set up the cameras focus and exposure remotely, a monitor can be connected to the Video Out BNC connector on the Multi-IOIOI. Use the Select Camera push button to switch the camera to the Video Output.
Serial Control can also be used through the Multi-IOIOI to select and set internal camera settings. The blue Video LED indicates the channel that is selected.
20. A device to trigger the cameras can be connected to the Trigger BNC connector. This is connected to the External Trigger within the cameras and is used to simultaneously trigger all the cameras at once. The trigger should be a switch closure. This will bring the 5-volt trigger line to ground and store the Cine inside the camera. The System Ready LED will go out and the 5-volt signal on the System Ready BNC will go to ground. These will go back to the "on" state when all the cameras have been put back into the Capture mode. As each camera is switched back into the Capture mode the Ready LED on that channel will light.

2.6 National Instruments USB X or M Series Data Acquisition Installation

This guide will explain how to connect a Phantom camera to the National Instruments devices in lieu of the SAM (Signal Acquisition Module)-3 device. The user will need to purchase/construct two custom cables that will connect the Phantom cameras' Capture cable or Break-out Box (BOB) to the National Instruments USB X and M Series devices' correct screw terminal ports. Specifically, the operator will be sending the cameras' STROBE and READY signals into the NI DAQ as timing/reference signals.

System Components

The entire system now consists of the following components:

- Phantom camera
- National Instruments X or M Series DAQ
- Interface cables between camera and DAQ (for STROBE & READY)
- Any external signals/wiring connected to the NI DAQ

Supported NI DAQ (Data Acquisition) Devices

USB X SERIES	USB M SERIES
NI USB-6341	NI USB-6221
NI USB-6343	NI USB-6221 BNC
NI USB-6351	NI USB-6229
NI USB-6353	NI USB-6229 BNC
NI USB-6356	NI USB-6225
NI USB-6361	
NI USB-6363 BNC	

NI USB-6366	
-------------	--

Required Materials/Tools:

- Windows XP, Vista, Windows 7 PC/Laptop
- PCC (Phantom Camera Control) Software (PCC 2.2 or above)
- Phantom camera
- Phantom Ethernet cable
- Phantom camera power adapter
- Supported National Instruments X or M Series DAQ
- Phantom-to-DAQ interface cable (x2)* (DAQ model dependent)
 - BNC-to-Flying lead coax adapter cable (for non-BNC DAQ models)
 - BNC-to-BNC coax cable (for BNC DAQ models)
- External signal(s) to input to NI DAQ

* Cables can be purchased or custom-made

Phantom-to-DAQ Interface Cable Determination

- If using a BNC DAQ model, the end-user will need to purchase or construct two coax cables.
 - These cables use BNC connections to interface with both the NI BNC DAQ and the Phantom camera (or camera Capture cable/Break-Out-Box).
 - Depending on the whether the user is connecting to a camera or Capture cable/Break-Out-Box, a Male-to-Female BNC adapter may be required (or the interface cable can simply be constructed/purchased this way)
- If using a non-BNC DAQ model, the user will need to purchase or construct (2) coax adapter cables.
 - These cables use a BNC connection to interface with the camera and flying leads (non-terminated wires) to interface with the DAQ screw terminal
 - The following list the 'Manufacturer, Model Number, and URL' of example interface cables that can be used:

MANUFACTURER	MODEL NO.	PRODUCT DESCRIPT	PRODUCT PAGE	DATA SHEET URL
Pomona	4969	BNC (f) w/20 AWG Leads	4969	4969 4970.pdf
Pomona	4970	BNC (m) w/20 AWG Leads	4970	4969 4970.pdf

- If the user will be constructing the cable, refer to 'BNC-to-Flying Lead Coax Adapter Cable Construction Notes'.

BNC-to-Flying Lead Coax Adapter Cable Construction Notes

1. For anything but the shortest cable runs, a properly-terminated, quality 50-ohm coax (e.g. RG59/U) must be used.
2. If using a Phantom camera Capture cable, the signals are terminated with male BNC connections, so a female BNC connector on the adapter cable is most efficient
3. If using a Phantom camera Break-out Box (BOB), the signals are terminated with female BNC connections, so a male BNC connector on the adapter cable is most efficient.
4. When terminating the other (non-BNC) end of the adapter cable, the user will need to use the center core as the signal

wire and the cable shielding as the ground wire.

5. The NI device uses isolated grounds so both STROBE and READY signals will each need their own ground that will be connected to separate, dedicated grounds on the NI device screw terminal board.

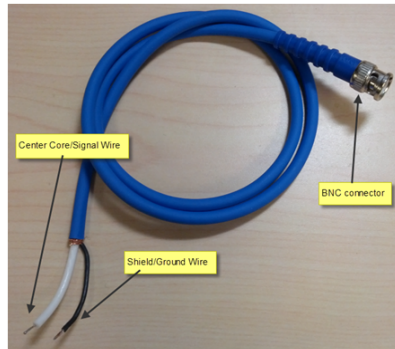

Phantom to NI DAQ BNC-to-Flying Lead Adapter cable (for STROBE & READY signals)

NI Software Setup

1. Follow the instructions provide with the National Instruments device to install:
 - a. National Instruments software
 - b. Device drivers
2. Ensure all relevant connections have been made. (See 'Connection Guide' below)
3. Apply power to National Instruments device.
 - a. National Instruments device should be detected by the:
 - 1) Operating system
 - 2) PCC software once opened in the Live>Advanced Settings>Signals dialogue window

Connection Guide

Table 1 below has been included as a sample and lists the pinout/screw terminal assignments for a specific model DAQ (NI USB 6361). Please be aware that other NI DAQ units may have different screw terminal numbers associated with the signal/connection names. The signal names are the same, however, refer to the NI product documentation in order to verify the respective screw terminal number.

1. Connect the Phantom camera Capture cable or Break-out Box (BOB) to the Phantom or MIRO camera
2. Connect the Phantom camera Capture cable or Break-out Box (BOB) 'STROBE' & READY signals to the adapter cables
 - a. Connect the STROBE signal:
 - i. Connect the STROBE signal BNC connector of the Capture cable or BOB to one of the adapter cable's BNC connector
 - ii. Connect the signal wire of this adapter cable to the 'PFI0' terminal
 - iii. Connect the ground wire to one of the 'D GND' terminals
 - iv. Do NOT connect any other ground wire to this 'D GND' terminal
 - b. Connect the READY signal:
 - i. Connect the READY signal BNC connector of the Capture cable or BOB to one of the adapter cable's BNC connector
 - ii. Connect the signal wire of this adapter cable to the 'PFI1' terminal
 - iii. Connect the ground wire to one of the 'D GND' terminals

- iv. Do NOT connect any other ground wire to this 'D GND' terminal
3. Connect any external analog data signals starting with the terminals labeled 'AI 0+' and 'AI 0-'
4. Connect any external digital data signals starting with the terminals labeled 'P0.0'

Table 1: Sample screw Terminal Assignment for NI USB X Series DAQ using one 0-10V Analog input

SIGNAL NAME	SIGNAL DESCRIPTION	SCREW TERMINAL ASSIGNMENT
PFI0	Aux +/STROBE signal	73
D GND	Aux -/STROBE signal ground	88
PFI1	READY signal	74
D GND	READY signal ground	90
AI 0 +	Analog Input signal (positive)	1
AI 0 -	Analog Input signal (negative or ground)	2

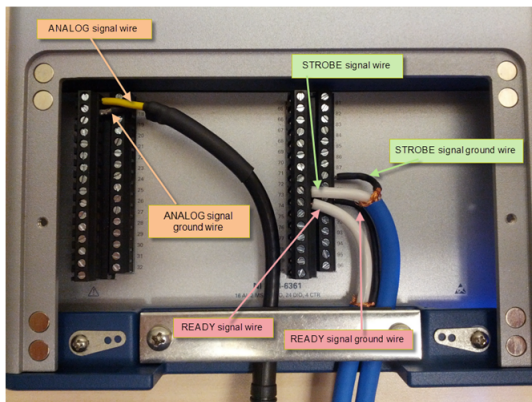

Sample Screw Terminal Connection for NI USB X Series DAQ using one 0-10V Analog input

2.7 NDIS 6 (10G) Driver Installation

Driver Install

The installation steps are:

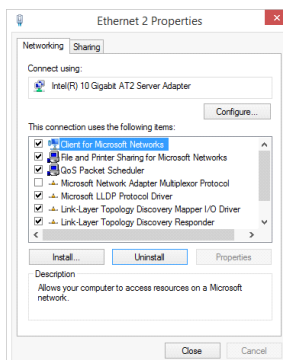

1. Uninstall an existing version of this driver if you already have on installed. See Driver Uninstall
2. Open the Network and Sharing Center Window
3. Open a Properties window for any of the ethernet adapters, it doesn't matter which one. It should look like this:

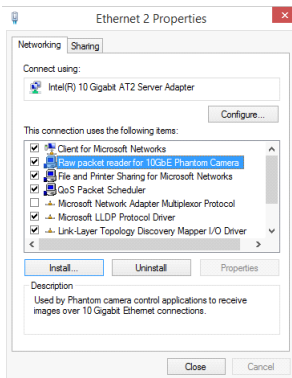
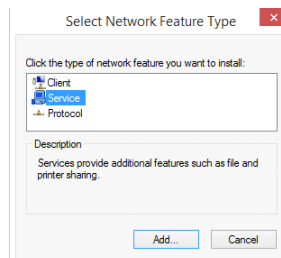

4. Press the Install... button. You should see a window like this one :
5. Select Service and press Add...
6. Press the Have Disk... button , browse for Ph10g.inf and press OK.

If everything worked you should see the installed driver in the Properties window

Driver Uninstall

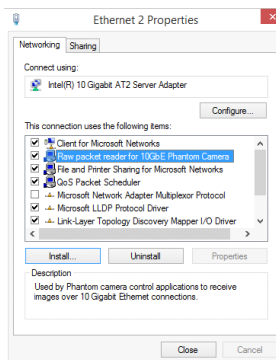

1. Open the Network and Sharing Center Window
2. Open a Properties window for any of the ethernet adapters. It should look like this:
3. Select "Raw packet reader for 10GbE Phantom camera" and press Uninstall

Using Winpcap

If the new driver is not installed, the application uses the old Winpcap driver for 10GbE image transfers, this is transparent to the users.

2.8 Phantom 10Gb Ethernet Installation

Introduction

A 10Gb Ethernet port can be found on the following products:

- Phantom CineStation-X2SR – Fiber X2SR connection
- Phantom CineStream-X2SR – Fiber X2SR connection
- Phantom CineStation-IV – Copper 10GBase-T connection
- Phantom Ultrahigh-Speed cameras (VXX1X) - Copper 10GBase-T connection

Establishing the 10Gb Ethernet connection on the PC requires installing a compatible 10Gb NIC (Network Interface Card) directly into a high-powered computer. Alternatively, a 10Gb Thunderbolt converter will work with your computer's Thunderbolt port.

Compatible cards and devices are (but are not limited to):

- For Copper 10Gbase-T devices
 - Intel x540-t1 or x540-t2 PCI-Express NIC
 - Promise Sanlink 2 Thunderbolt adapter
- For X2SR devices such as the CineStation-X2SR
 - Myricom 10G-PCIE-8A-R NIC with Finisar transceiver FTLX8511D3
 - Intel X520-SR2 NIC (includes transceiver)

Procedure

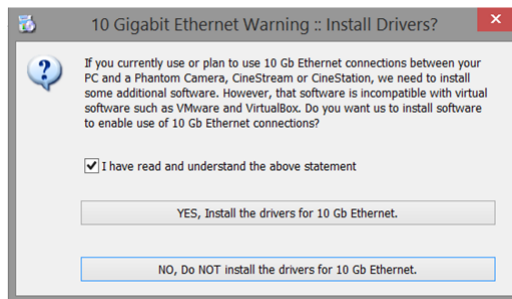

1. NIC installation: Physically install the recommended card for your device, and install the latest driver for the NIC or thunderbolt converter, usually available for download on the manufacturer's website. A reboot of the system is usually required after the 10Gb NIC installation.
2. PCC Software: Install the latest PCC software, or ensure that at minimum PCC software version 2.6 is installed on the PC
3. Phantom 10Gb Driver: During software installation, a prompt will verify that the 10Gb driver install is necessary. Say yes.
If the software was previously installed without the Phantom 10b Driver, it can be installed from the PCC loader menu.



The Phantom 10G driver replaces the 'winpcap' utility which earlier versions of Phantom PCC used for 10Gb connection.

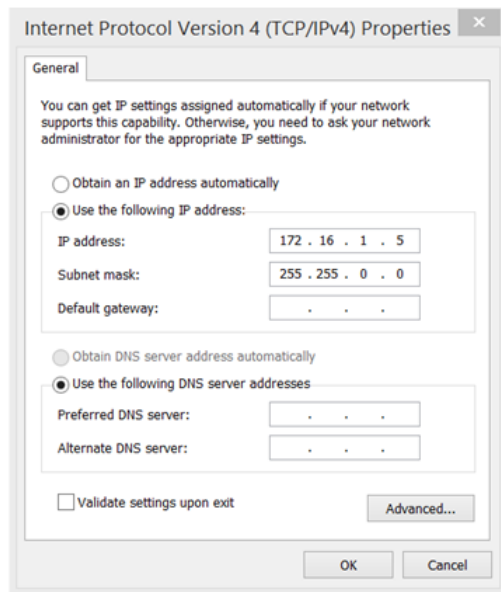

1. Power on and connect the Phantom device to the installed 10Gb NIC.
 - a. For 10GBase-T (Copper) devices, the network cable should be rated Cat6a or greater
 - b. For X2SR devices, multimode SC-LC fiber should be used
5. Assign network: All Phantom devices have a unique 10Gb network address, and the PC's 10Gb port must be configured to the same network range as the device in order to recognize it. In network settings, find the new 10Gb network, click on 'properties' and assign the IPv4 as follows <refer to image>:
 - a. IP Address: 172.16.1.1 (Note if more than one 10G port is available they will need to be assigned different IP addresses, within the same range, such as: 172.16.1.2; 172.16.1.3.. etc)
 - b. Subnetwork Mask: 255.255.0.0

Once configured, PCC should now recognize the device and allow for control and file download accordingly.



Important Notes:

1. 10Gb Ethernet allows for greatly increased Cine playback and download speeds. It is important to understand that in order to maximize download speeds, in addition to installing the 10Gb link on the PC end, the entire system must be considered. For example, if you are using the 10Gb connection on a very powerful PC to save Cine files to a USB2 drive, you will see no increase of speed because of the limitations of that USB connection. Solid State (SSD) drives are recommended, and a striped SSD Raid array is ideal with drives and connection rated to achieve 10Gb speeds.
2. Be aware of every component in the save process to avoid potential bottlenecks in your system and to achieve desired results.
3. At the time of writing, a dedicated 10Gb Ethernet setup using PCC with a vXX1X camera or CineStation IV will achieve approximately 500-600 Mb/second (Cine Raw) download speed to an internal striped SSD Raid array.

2.9 Restore v6.2e Camera to Factory Calibration Settings

Whenever you want to restore the calibration settings of a Phantom camera, you need to have the factory supplied STG files containing the information for the camera. It is advisable to store these files in a safe place and use them when necessary.

Whenever you want to restore the settings of one or several Phantom v6.2e Camera imaging heads, you need to have the factory setting files containing the information for every head. It is advisable to store these files in a safe place and use them when necessary.

STEP-BY-STEP PROCEDURE

All Phantom Cameras Except Phantom v6.2e via Phantom (PCC) Camera Control Application

1. Start the Phantom (PCC) Camera Control Application .
2. Click the Manger Control Panel tab.

3. Select the Phantom camera for use.
 - a. Click the select the Camera>Load Settings command in the Phantom (PCC) Camera Control Application - Main Screen.
 - b. From the Load Camera Settings window:
 - 1) Navigate to the folder containing the original, (backup), .stg file provided by Vision Research with the camera.
 - 2) Click on the .stg file.
 - 3) Click the Open button.
 - e. Exit the Phantom Camera Control (PCC) Application.
 - f. Restart the Phantom Camera Control (PCC) Application.

2.10 SAM-3 (Signal Acquisition Module) Installation

Vision Research is no longer offering the Signal Acquisition Module (SAM-3) as a supported accessory for future cameras and software versions. The previously-supported Data Translation DT9802 and DT3010 data acquisition devices have been replaced with the National Instruments USB X and M Series devices. See [Accessories, Peripherals, and Miscellaneous Features>NI \(National Instruments\) USB X or M Series Data Acquisition Installation](#).

However some Phantom cameras and PCC application can still utilize the SAM-3 (Signal Acquisition Module-3) system to tag image frames with signal information supplied through a Data Translation DT9802 and DT3010 Series Data Acquisition Modules. This mechanism is an extension of the time stamp storage system; these data tags are treated very much like time stamps and the event signal.

To use the SAM-3 (Signal Acquisition Module-3) system with a Phantom Camera and the Phantom Camera Control application, the DT9802 or DT3010 Series Device Drivers must be loaded in the Phantom Control Unit, as follows:

STEP-BY-STEP PROCEDURE

Minimum System Requirements

For reliable operation, the Data Acquisition DT9802 or DT3010 Series board requires the following minimum system requirements:

System type: IBM-PC or compatible

Microprocessor: Pentium-class 1.4GHz or higher

Interface: A minimum of one available USB Port (Model DT9802); A minimum of one available PCI (revision 2.0-compliant or greater), 32-bit or 64-bit, +5 V expansion slot (Model DT3010)

Operating system (English versions): Windows 2000; Windows XP Pro (32 & 64 Bit); Windows XP Tablet Edition; Windows Vista Business Edition (32 & 64 Bit); Windows Vista Enterprise Edition (32 & 64 Bit); Windows Vista Ultimate Edition (32 & 64 Bit)

Administrative Privileges: Required for installation and operation

RAM Memory: 512 megabytes minimum; 4 Gigabytes recommended for Phantom v9 Series, v10, v12 Series, v210, v310, v640, and v710

Hard drive: 40 gigabytes minimum available hard drive space (Phantom v4, v5, v6, and v7 series cameras); 80 gigabytes (Phantom v9 series, v10, and v12 cameras)

CD-ROM drive: Any speed with write capability

Monitors: SVGA 1024 x 768 x 24bit color small fonts (Phantom v4 Series); UltraXGA 1284 x 1024 x 24bit large fonts (Phantom Miro Series, v5 Series, v6 Series, v7 Series, v9 Series, v10, v12 Series v210, v310, v640, and v710)

Ethernet: Phantom Miro Series, v4 Series, v5 Series, v6 Series, v7.0, and v7.1: NIC 10/100 or higher card installed;

Phantom v7.2, v7.3, v9 Series, v10, v12 Series, v210, v310, v640, and v710 Gigabit Ethernet Jumbo Frame Support
Once you have verified that your system meets the system requirements, install the software as described in the next topic.

Software Installation

DataAcqOMNI_CD: Using the Data Acquisition Omni CD - Installation CD provided by the Data Translations with your Data Acquisition Unit, start the installation program, and follow the on-screen instructions.



This version of the software provides WDM-compliant device drivers and DLLs (version 5.0 or greater). Other Data Translation boards may not provide WDM-compliant files. Use of a DT9800 Series board is restricted from being used at the same time another Data Translation board is in use, unless both devices provide WDM-compliant files.

Module Installation

Model DT9802

1. Setup the computer.



To prevent electrostatic damage that can occur when handling electronic equipment, use a ground strap or similar device when performing this installation procedure.

- a. Turn off the Phantom Control Unit computer.
- b. Turn off all peripherals (camera, printer, modem, monitor, and so on) connected to the Phantom Control Unit computer.
- c. Attach one end of the EP310 cable, which is shipped with the DT9802 Series module, to the USB port on the module.
- d. Attach the other end of the EP310 cable to one of the USB ports on the host computer (The operating system automatically detects the USB device.)

Model DT3010

1. Setup the computer.



To prevent electrostatic damage that can occur when handling electronic equipment, use a ground strap or similar device when performing this installation procedure.

- a. Turn off the Phantom Control Unit computer.
 - b. Turn off all peripherals (printer, modem, monitor, and so on) connected to the Phantom Control Unit computer.
 - c. Unplug the Phantom Control Unit computer and all peripherals.
 - d. Remove the cover from your Phantom Control Unit computer. Refer to your computer's user's manual for instructions.
2. Select an Expansion Slot for Use.
 - a. Select a 32-bit or 64-bit PCI expansion slot.



PCI slots are shorter than ISA or EISA slots and are usually white or ivory. Commonly, three PCI slots (one of which may be a shared ISA/PCI slot) are available. If an ISA board exists in the shared slot, you cannot use the slot for a PCI board; if a PCI board exists in the shared slot, you cannot use the slot for an ISA board.

- b. Remove the cover plate from the selected expansion slot.
- c. Retain the screws that held the cover plate in place; you will use them later to install the board.

3. Insert the DT3010 Module into the Phantom Control Unit Computer.



Before removing the DT3010 module from its anti-static bag you will need to discharge any static electricity by holding the wrapped board on one hand while placing your other hand firmly on a metal portion of the computer chassis.

- a. Carefully remove the anti static packing material from the board. (It is recommended that you save the original packing material in the unlikely event that your board requires servicing in the future.)
- b. Hold the board by its edges and do not touch any of the components on the board.
- c. Position the board so that the cable connectors are facing the rear of the computer as shown in the figure below.

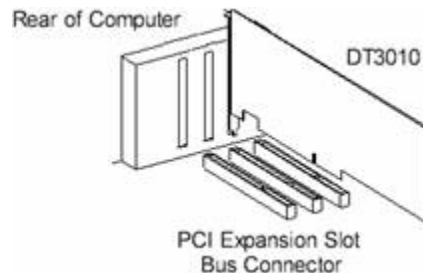

- d. Carefully lower the board into the PCI expansion slot using the card guide to align the board in the slot properly.
- e. When the bottom of the board contacts the bus connector, gently press down on the board until it clicks into place.



Do not force the board into place. Moving the board from side to side during installation may damage the bus connector. If you encounter resistance when inserting the board, remove the board and try again.

- f. Secure the board in place at the rear panel of the system unit using the screw removed from the slot cover.
- g. Place the cover back on the computer. Refer to your computer's user's manual for instructions.

Model DT9802 Device Driver Installation

Once you have installed the DT9802 Series driver from the Data Acquisition OMNI CD and performed the DT9802 Model Installation process.

1. Power up the computer.
2. From the Control Panel, double-click the Open Layers Data Acquisition Control Panel icon.
 - a. Click Next.
 - b. Select the DT9802 Series module.
 - c. Click Advanced.
 - d. If you are using differential analog input channels, it is recommended that you select the 10k Ohm Resistor Terminations checkbox for each analog input channel on the module. This ensures that 10 k of bias return termination resistance is used for the analog input channels. (This is the default configuration.) Bias return termination resistance is particularly useful when your differential source is floating.
If you are using single-ended analog input channels, clear the checkbox for each analog input channel so that bias return resistance is not used.
 - e. To continuously power the analog and/or digital outputs, select the Power Always On checkbox. The DT9800 Series module will remain on even when you exit from the applications that use the module.
If you want to shut down power to the module, you must uncheck this checkbox and close the control panel. Once all applications that use this module are exited, the module will power down. The module will remain off

until you either run an application that uses the module, or click the Advanced button from the Open Layers Data Acquisition Control Panel.

- f. Click OK.
- g. If you want to rename the module, click Edit Name; enter a new name for the module, then click OK, if not skip to Step 3.



This name is used to identify the module in all subsequent applications.

- h. When you are finished configuring the module, click Close.
3. Close the Control Panel.

Model DT3010 Device Driver Installation

For Windows 2000 Professional Edition

Once you have installed the DT3010 Series driver from the Data Acquisition OMNI CD, installed a DT3010 Series board.

1. Power up the computer.
2. When the New Hardware Found dialog box appears:
 - a. Click Next.
 - b. Click Search for a suitable driver for my device (recommended).
 - c. Click Specify a location, and click Next.
 - d. Browse to WinNT/System32/Drivers/DT3010.Inf, and click Open.
 - e. Click OK.
 - f. Click Next.
 - g. Click Finish.
 - h. Open the Control Panel.
 - i. Double-click on the Open Layers Control Panel icon.
 - j. Select the DT3010 Series board to configure, and then click Advanced.
 - k. Ensure the "Handles Overloaded Bus?" is enabled (checked).
 - l. Click Close.



This name is used to identify the module in all subsequent applications.

- h. When you are finished configuring the module, click Close.
3. Close the Control Panel.

For Windows XP Professional Edition

Once you have installed the DT3010 Series driver from the Data Acquisition OMNI CD, installed a DT3010 Series board.

1. Power up the computer.
2. When the New Hardware Found dialog box appears:
 - a. Click Next.
 - b. Click Search for a suitable driver for my device (recommended).
 - c. Click Specify a location, and click Next.

- d. Browse to Windows/System32/Drivers/DT3010.Inf, and click Open.
- e. Click OK.
- f. Click Next.
- g. Click Finish.
- h. Open the Control Panel.
- i. Double-click on the Open Layers Control Panel icon.
- j. Select the DT3010 Series board to configure, and then click Advanced.
- k. Ensure the "Handles Overloaded Bus?" is enabled (checked).
- l. Click Close.

Hardware Connections

Attaching the SAM-3 Module to the Phantom Camera w/Model DT9802

1. Connect the Custom External Link cable to the 19-pin connector on the rear of the Phantom camera.
2. Locate the STROBE connector, labeled on the Custom External Link cable and attach it to the connector labeled STROBE on the SAM-3 module.
3. Locate the READY connector, labeled on the special order Capture cable and attach it to the connector labeled READY on the SAM-3 module.

The following diagram shows the connections that must be made from the Phantom Camera to the Data Translation DT9802.

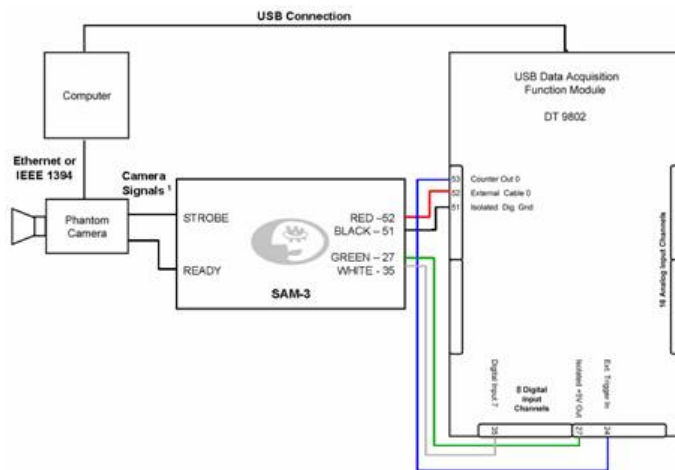

SAM - 3 (Signal Acquisition Module for Phantom Cameras)

Attaching the SAM-3 to the DT9802 Screw Terminal Panel

1. Connect the Red - 52 wire of the SAM-3 module to terminal screw #52 connector of the DT9802 screw terminal panel.
2. Connect the Black - 51 wire of the SAM-3 module to terminal screw #51 connector of the DT9802 screw terminal panel.
3. Connect the Green - 27 wire of the SAM-3 module to the terminal screw #27 connector of the DT9802 screw terminal panel.
4. Connect the White - 35 wire of the SAM-3 module to terminal screw #35 terminal connector of the DT9802 screw terminal panel.
5. Connect a jumper wire between the terminal screw #24 (Ext. Trigger In) and terminal screw #53 (Counter Out 0) of the DT9802 screw terminal panel.

Attaching the DT740 Screw Terminal Panel to the DT3010

The DT740 screw terminal panel is provided for DT3010 modules.

1. Connect the EP307 cable from J1 (top connector) on the rear of the DT3010 module to J1 connector of the DT740 screw terminal panel.
2. Connector J1 on the screw terminal panel brings out all of the analog signals from connector J1 on the board.
3. Connect the EP308 cable from J2 (bottom connector) on the rear of the DT3010 module to J2 connector of the DT740 screw terminal panel.
4. Connector J2 on the screw terminal panel brings out all of the digital and counter/timer signals from connector J2 on the board.

The figure below illustrates how to attach the DT740 screw terminal panel to the DT3010 board.

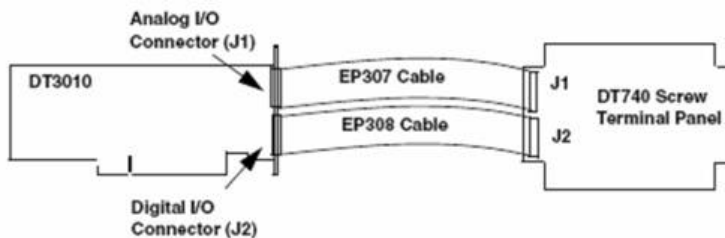

Attaching the DT740 Screw Terminal Panel to the DT3010

The DT740 screw terminal panel is provided for DT3010 modules.

1. Connect the EP307 cable from J1 (top connector) on the rear of the DT3010 module to J1 connector of the DT740 screw terminal panel.
2. Connector J1 on the screw terminal panel brings out all the analog signals from connector J1 on the board.
3. Connect the EP308 cable from J2 (bottom connector) on the rear of the DT3010 module to J2 connector of the DT740 screw terminal panel.
4. Connector J2 on the screw terminal panel brings out all the digital and counter/timer signals from connector J2 on the board.

The figure below illustrates how to attach the DT740 screw terminal panel to the DT3010 board.

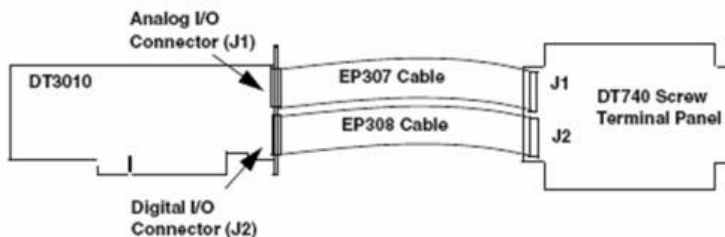

Attaching the DT740 Screw Terminal Panel to the SAM-3

1. Connect the Red wire from SAM-3 module to terminal screw #60 on the DT740 terminal panel.
2. Connect the Black wire from SAM-3 module to terminal screw #82 on the DT740 terminal panel.
3. Connect the White wire from SAM-3 module to terminal screw #104 on the DT740 terminal panel.
4. Connect the Green wire from SAM-3 module to terminal screw #112 on the DT740 terminal panel.
5. Connect a jumper wire between the terminal screw #59 and terminal screw #77.

The figure below illustrates the layout of the DT740 Terminal Panel.

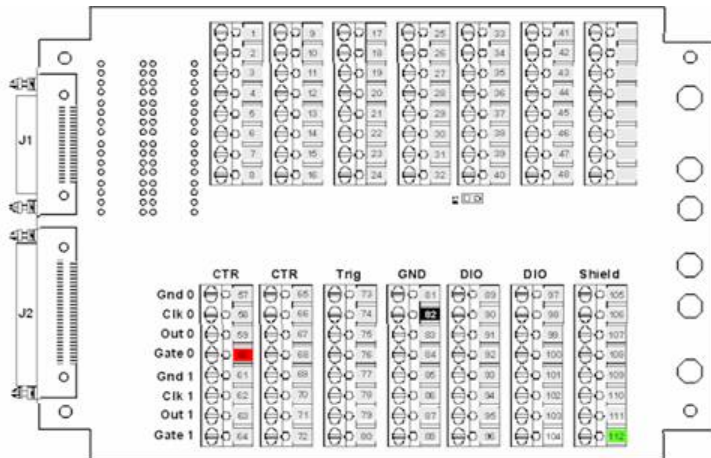

Attaching the SAM-3 Module to the Phantom Camera w/Model DT3010

1. Connect the Custom External Link cable to the 19-pin connector on the rear of the Phantom camera.
2. Locate the STROBE connector, labeled on the Custom External Link cable and attach it to the connector labeled STROBE on the SAM-3 module.
3. Locate the READY connector, labeled on the special order Capture cable and attach it to the connector labeled READY on the SAM-3 module.

The following diagram shows the connections that must be made from the Phantom Camera to the Data Translation DT3010.

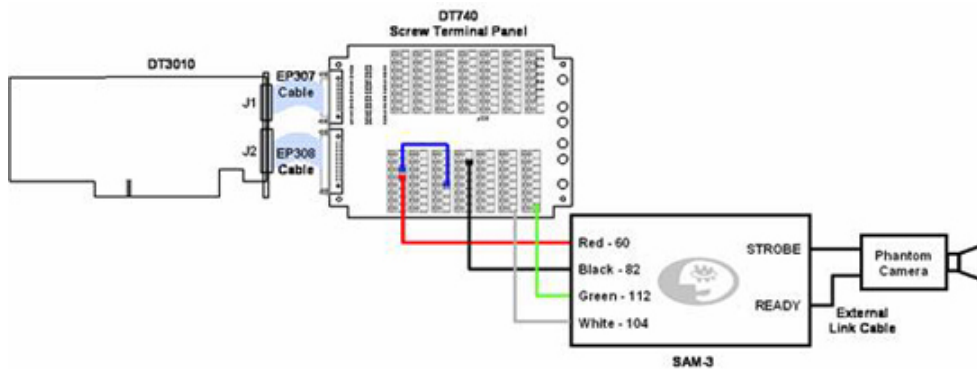

Defining the Phantom Camera Control Signal Acquisition Inputs via the Phantom (PCC) Camera Control Application

1. Click the Live Control Panel Tab.
2. Click on Advance Settings.
3. Click the Signals button.
4. In the Analog and Binary Signal Acquisition dialogue window:
 - a. Specify the desired Channel counts by clicking the down-arrow next to the used:
 - 1) Binary entry field to specify the number of binary input signals to be used, (tagged), and/or
 - 2) Analog entry field to specify the number of analog input signals to be used, (tagged).



The Available display windows, for both Binary and Analog indicate the number of channels supported.

- b. Select the desired Samples by click on the associated radial button:
- 1) 1 Sample per image directs the system to capture 1 sample per image.
 - 2) Max samples per image directs the system to capture multiple samples to each image. This maximum number of samples is displayed in the Sample per Image field.



The more channels being sampled the smaller the Sample per image will become. You can choose "1 Samples per image" or a "Maximum number of samples per image", which will be calculated by the Phantom Camera Control application. The maximum number of samples is determined by the frame rate and the number of channels be sampled.

- c. Define the Analog Channels, (ACh0 through ACh7 that represent the analog channel inputs connect to the data acquisition module):
- 1) Enable, (check), Bipolar range to instruct the system to capture a value defined by two inputs, (positive and negative value samples), or
 - 2) Enable, (check), Differential inp. to instruct the system to capture a differential input.
 - 3) Specify a Name to define a nomenclature to channels ACh0 through ACh7, (Analog Channel 0 through Analog Channel 7), for ease of reference.
 - 4) Use the down-arrow next the an AnaGain, (Analog Gain), entry window to adjust the gain value in preset gains.
 - 5) Enter a Gain to adjust the value to the required measurement value.
 - 6) Specify the Unit, the measurement unit, (i.e., PSI - Pounds per Square Inch, etc.)
 - 7) Enter the ACh channel number, (the analog channel ACh8 through ACh32), to view its sample value. When more than 8 channels are selected, the values for AnaGain and Gain parameters of channels ACh8 through ACh32 is the same with those of ACh7.



The Current Value information fields display the current sample value. The Parameters from ACh7 indicates the Current Value for the channel specified in the ACh field just to the left of the Parameter from ACh7 field.

- d. Define the Binary Channels, (BCh0 through BCh7 that represent the binary channel inputs connect to the data acquisition module):
- 1) Specify a Name to define a nomenclature to channels BCh0 through BCh7, (Binary Channel 0 through Binary Channel 7), for ease of reference.
 - 2) Enter the BCh channel number, (the binary channel BCh8 (DT9802), or BCh8 through BCh14 (DT3010), to incorporate the sample value information, when more than 8 binary channels are sampling data via the data acquisition module.



The Value information fields display the current state of the binary signal being sampled.

- e. Ensure the Board informational field indicates the correct type of board used to perform the data acquisition.

Viewing Signal Acquisition (Analog Channels)

By default the chart displays a graph of all measurement values for all analog signals specified by the user in the Live>Advanced Settings>Signals dialogue window. The software assigns each channel a unique color. The numbers below the chart are the frame numbers of the Cine file; numbers to the right represent the measurement value. The green line, visible in the zoomed view, represents the position of the trigger frame; the white line is the current frame position. The dots on each channel are the acquired signal values (measurements).

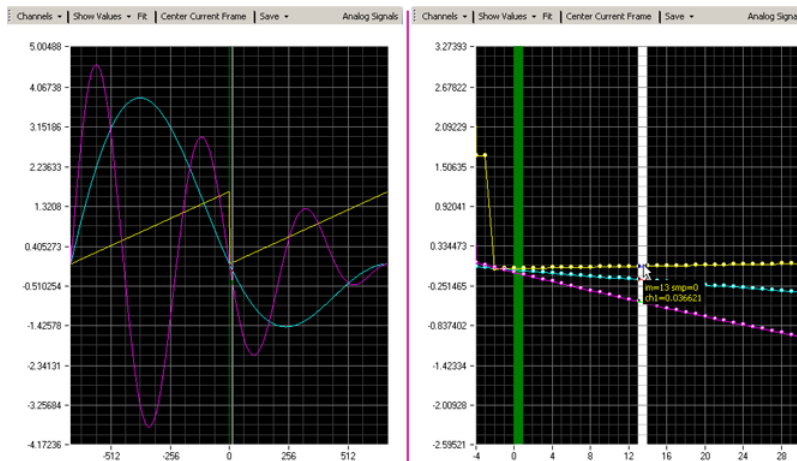

Signal Acquisition Chart displaying three analog acquisition signals (left); zoomed view (right)

Placing the cursor over an analog sample will display the following information:

- im (image) - indicates the image number the specified reference point of the signal is associated with.
 - smp (sample) - indicates the sample number of the specified reference point for the associated image.
 - ch (number) - indicates the associated value (dependent on what the signal represents) of the reference point.
1. Click the Channels pull-down selection list to specify the channel(s) to be displayed (by default all channels are displayed).
 2. Click Show Values / Zoom pull-down selection list to:
 - a. Show Values - used to display a signal value by moving the cursor over the analog signal(s) in the chart.
 - b. Window / Horizontal / Vertical Zoom - used to drill down into the graphical display to view measurement points.
 - c. Zoom In Around Point / Zoom Out Around Point - used to zoom in to / out of the display by holding down the left mouse button until the desired level of zoom is reached or right mouse click on display and select the 'Zoom In / Out Around Point' one time.
 - d. Pan - moves the chart around by holding in the left mouse button and moving the mouse in the direction you wish to move the chart.
 3. Click 'Fit' to reset the display window to its original size to display the entire signal range for all frames.
 4. Click 'Center Current Frame' to center the chart so the current frame is displayed in the center of the chart.
 5. Click 'Save' to create a comma separated text file and select the type of file to be saved from the pull-down selection list:
 - a. All - creates a report file for all the analog channels visible or not.
 - b. Visible - creates a report file for the visible analog channels only.
 6. In the 'Save Signal(s)' dialogue window navigate to the folder the report file is to be saved to.
 7. Enter a filename for the report file being saved in the 'File name:' field (software will automatically add the .cvs file extension).
 8. Click 'Save' to create file; 'Cancel' to abort.

Viewing Signal Acquisition (Binary Channels)

By default the chart displays a graph of all measurement values for all digital signals specified by the user in the Live>Advanced Settings>Signals dialogue window. The numbers below the chart are the frame numbers of the Cine file. The green line, visible in the zoomed view, represents the position of the trigger frame; the white line is the current frame position.

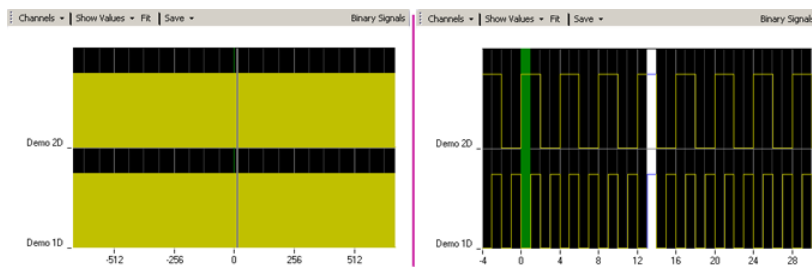

Signal Acquisition Chart displaying two digital signal acquisition channels (left); zoomed view (right)

1. Click the Channels pull-down selection list to specify the channel(s) to be displayed (by default all channels are displayed).
2. Click Show Values / Zoom pull-down selection list to:
 - a. Show Values - used to display a signal value by moving the cursor over the analog signal(s) in the chart.
 - b. Horizontal Zoom - used to drill down into the graphical display to view measurement points.
 - c. Zoom In Around Point / Zoom Out Around Point - used to zoom in to / out of the display by holding down the left mouse button until the desired level of zoom is reached or right mouse click on display and select the 'Zoom In / Out Around Point' one time.
 - d. Pan - moves the chart around by holding in the left mouse button and moving the mouse in the direction you wish to move the chart.
3. Click 'Fit' to reset the display window to its original size to display the entire signal range for all frames.
4. Click 'Save' to create a comma separated text file and select the type of file to be saved from the pull-down selection list:
 - a. All - creates a report file for all the analog channels visible or not.
 - b. Visible - creates a report file for the visible analog channels only.
5. In the 'Save Signal(s)' dialogue window navigate to the folder the report file is to be saved to.
6. Enter a filename for the report file being saved in the 'File name:' field (software will automatically add the .csv file extension).
7. Click 'Save' to create file; 'Cancel' to abort.

2.11 Sensor and Lens Cleaning

Sensor cleaning is a hot topic for digital camera users - Phantom and otherwise - and there are definite techniques on tackling it. Depending on your lighting situation, a tiny speck of dust on your sensor can lead to a big ugly spot on your images, which is a shame because it is usually avoidable. The longer the lens and smaller the aperture, the more pronounced the spots will appear on your image.

The No.1 rule is that if the dust can be removed without using a solvent, you will save yourself a lot of headaches in getting rid of it! Use the Sensor Sweep brush, ([link below](#)), as it attracts the particles to the bristles. Be sure to follow the directions. You must clean the brush by blowing air on it and sweeping it across a vellum-like surface to charge the bristles before each sweep on the sensor glass. You can also use the brush to clean the area around the sensor as dust can settle there and then get attracted back onto the sensor glass. Make sure to always blow the bristles free of dust before storing it within its container.

Compressed air is OK as a quick solution, but always test the spray first away from the sensor to make sure none of the fluid comes out. Use short bursts and hold the can upright. A better solution would be to use a blower that recycles air to force the dust off of and from around the sensor.

If there is a smudge or dust that won't go away, try a micro fiber lens cleaning cloth to gently wipe the smudge away. Just like the brush, keep the cloth clean, if you reuse them, they can build up residue, which will end up back on the sensor

glass. For very stubborn smudges, you might want to wrap the micro fiber cloth or a piece of lens tissue around a pencil eraser or long swab for better control. If that doesn't work, a drop or spray of lens cleaning solution on the cloth will do the trick.. make sure it isn't too wet before wiping it on the sensor glass. Lens tissue folded into a point with a drop of lens solution can help very concentrated spots as well.

TECH TIPS

- Use a tiny flashlight to look at the sensor, it's easier to spot the dust.
- Always have a clean micro fiber cloth handy for more serious dirt.
- Cotton swabs aren't a good idea, unless they are wrapped in a micro fiber or lens tissue like material. They leave behind more than they remove.
- Never use your finger to get a speck of dust off, it's going to make things much worse.
- Never blow on the sensor itself (as tempting as it is).
- Always keep the Phantom Body cap on the camera when there is no lens attached.

Lenses gather a lot of dust as well, which can also wreak havoc on your images. Always keep the rear and front elements protected with their lens caps. There are many products out there safe for cleaning lenses, Here at Vision Research, we find that a micro fiber cloth with one spray of Eclipse or Pan-cro solution (on the cloth) works at the fastest with the best results.

A Sensor and Lens Care Kit can be found at: http://phantomhighspeed.com/store/index.cfm?fuseaction=product.display&product_ID=140

2.12 Sync Imaging (Camera Network Options)

Overview

The internal frame rate generator outputs 4 μ s negative pulses on fsync to initiate acquisition of image frames. 3-4 μ s after a negative edge is detected at fsync, integration starts (and strobe goes low). A new exposure cannot start until 7 μ s after the previous one has ended, unless set for use in a PIV (Particle Imaging Velocimetry) application. If a fsync pulse is detected before an exposure can start, it is latched and a new frame will start at the earliest possible opportunity. Also, an exposure cannot end until the previous frame was completely read out from the sensor. If such a case occurs, the integration period is extended until the readout has completed, overriding the exposure time setting.



The fsync signals of several cameras in a system can be connected in parallel to obtain synchronous operation. Up to 4 cameras can be connected in this way if the total cable length is kept to less than 10 meters.

When several cameras are connected together via the FSYNC, the one with the Sync setting defined as Internal will become the master. Proper synchronization can only occur if the exposure time of all cameras in the system is less than the reciprocal of the fastest running camera, as the shutter time has priority over FSYNC, unless otherwise designated. When the master in a system has been predetermined, the slave cameras can have the 'sync imaging' flag set, by setting their Sync parameter to External, which will disable their internal frame rate generators.

The user can also set the estimated frame rate before enabling external Sync. That value will be used to check the exposure and EDR, if:

- The Master camera serial setting is not 0, and
- There is a connected camera with that serial number, and
- The selected camera is set to Sync External mode.

Then the:

- Frame rate from the master is written to slave; it is used to check the exposure and EDR of the slave and to display a Cine duration at the slave.
- The number of Post Trigger frames is taken from master and it is disabled on slave.
- Capture and Trigger are disabled on slave; the commands on the master camera are sent to the slave too.
- Frame rate profile is copied from master to slave.

A cable connection between cameras is needed for the Master-slave Sync. Up to 3 slave cameras can be connected to the same master camera.

There are basically three modes of Sync Imaging:

- Internal - Uses the camera's internal crystal oscillator as the clock source.
- External - Uses an external clock source to clock the Phantom camera.
- IRIG - Uses an IRIG-B clock source to clock the Phantom camera.

STEP-BY-STEP PROCEDURE

Selecting the Camera's Sync Imaging Option via the Phantom (PCC) Camera Control Application

1. Start the Phantom (PCC) Camera Control Application .
2. Click on the Live Panel tab, then
3. Click on the Advanced Setting selector.
4. Specify the External Sync option:
 - a. Click the down-arrow, to the right of the Sync Imaging field to display a drop down list box, then
 - b. Select the desired clocking option from the list:
 - 1) Internal: Select this mode to use the cameras internal crystal oscillator to drive the camera's sample rate.
 - 2) External: Select this mode when an externally supplied pulse will drive the camera's sample rate. The external input must be a TTL pulse, with a frequency up to the maximum sample rate.
Example: 1000Hz @ 512 x 512 resolution, 2000Hz @ 256 x 512 resolution.
The TTL input pulse must be connected to the BNC connector marked Sync on the 19-pin Capture breakout cable.



When selected the Sample Rate option will be disabled.

- 3) IRIG: Select the mode when an IRIG-B signal is supplied through the marked IRIG Input BNC connector on the 19-pin Capture breakout cable.



Selecting either the External option will cause the Phantom camera to lock up if the respective input signal is not available. If there is no external or IRIG-B clock source the Internal option MUST BE selected.

Defining a Phantom Camera as the Master Clock Source for Serial Connected Cameras via the Phantom (PCC) Camera Control Application

The Master camera forwards the f-sync signal to the remaining cameras, serially, in the application shown below.

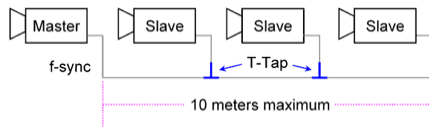

Serial Camera Application

The Multi-IOIOI or Multi-IOIOG unit forwards the f-sync signal to the remaining cameras, in parallel, in the application shown below.

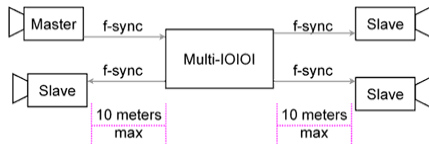

Multi-IOIOI or Multi-IOIOG Application



When utilizing the fsync feature, all cameras must be supplied an external trigger. If a soft-trigger is used to trigger the cameras, Vision Research cannot guarantee that the cameras will remain synchronized.

1. Ensure f-sync (frame synchronization) cabling does not exceed 10m (end to end).
2. Determine which camera will use its internal oscillator to supply f-sync clock pulse.
3. From the Phantom Camera Control's software, Live Panel>Advanced Settings>External Sync, define the Sync Imaging parameter, for the master clock source camera, as Internal.
4. From the Phantom Camera Control Software, Live Panel>Advanced Settings>External Sync, define the Sync Imaging parameter for all the remaining cameras, being clocked by the master clock camera, to External.
5. For all cameras, in the Live Panel>Advanced Settings>External Sync options:
 - a. Enter the serial number of the master clock source camera in the External Sync>Master Camera Serial field, then
 - b. Set the Frame rate delay, of all cameras accepting the master cameras provided clock, at least $1\mu\text{s}$ greater than that of the master camera.



The serial number can be found on the side of each camera.

6. Ensure the Exposure time setting, of the Externally timed cameras, does not exceed the maximum Exposure time of the master clock source camera.
7. Ensure that the PostTrigger setting of the master clock source camera is set to a value that is one frame greater than the PostTrigger setting of the Externally timed cameras.

Using an External Clock Source to Synchronize multiple Phantom Cameras via the Phantom (PCC) Camera Control Application

The f-sync signal is forward to each of the cameras independently, in the applications shown below.

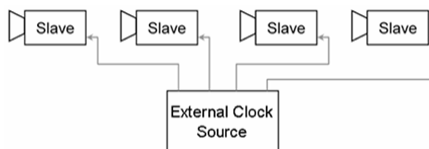

Serial Camera Application

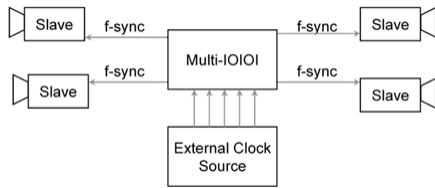

Multi-IOIOI or Multi-IOIOG Application



When utilizing the fsync feature, all cameras must be supplied an external trigger. If a soft-trigger is used to trigger the cameras, Vision Research cannot guarantee that the cameras will remain synchronized.

1. From the Phantom (PCC) Camera Control Application, Live Panel>Advanced Settings>External Sync options, define the Sync Imaging parameter, for all the cameras being synchronized, to be clocked External.
2. Ensure the Frame Rate and Post Trigger settings match for all cameras.
3. In the Live Panel>Advanced Settings>External Sync options, enter <0> (zero) in the Master Camera Serial field.

Using an IRIG-B Clock Source to Synchronize multiple Phantom Cameras via the Phantom (PCC) Camera Control Application

The f-sync signal is forward to each of the cameras independently in the applications shown below.

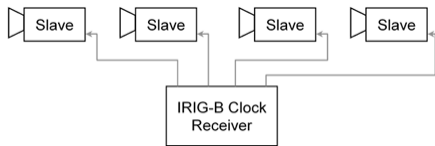

Serial Camera Application

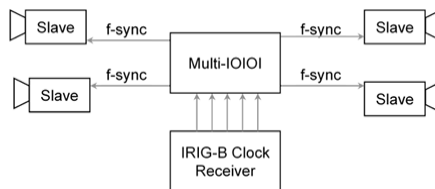

Multi-IOIOI or Multi-IOIOG Application



When utilizing the fsync feature, all cameras must be supplied an external trigger. If a soft-trigger is used to trigger the cameras, Vision Research cannot guarantee that the cameras will remain synchronized.

1. From the Phantom (PCC) Camera Control Application, Live Panel>Advanced Settings>External Sync options, define the Sync Imaging parameter, for all the cameras being synchronized, to be clocked IRIG.
2. Ensure the Frame Rate and Post Trigger settings match for all cameras.
3. In the Live Panel>Advanced Settings>External Sync options, set <0> (zero) in the Master Camera Serial field.

2.13 Use in PIV (Particle Imaging Velocimetry) Applications

STEP-BY-STEP PROCEDURE

To Minimize the Frame Straddle Time (Inter-Frame Gap) via Phantom (PCC) Camera Control Applications

In the Live Panel > Advanced Settings>Cine Advanced, enable, (check), the Exposure in PIV Mode. When enabled the

Phantom v710 and v12.1 will be instructed to reduce the Frame Straddle Time to 500 nano-seconds, the Phantom v310 is instructed to reduce the Frame Straddle Time to 660 nano-seconds, the Phantom v210 to 700 nano-seconds, a Phantom v640 to 1.2 micro-seconds, and the Phantom v10, v9.1, v7.3, and v5.2 to 1.5 micro-seconds.

To Verify this Interval

Connect the Strobe signal BNC connector, (of the 19-pin Capture cable), to the signal input connector on an oscilloscope and set the desired resolution and frame rate settings. Then manually enter an exposure rate greater than the maximum exposure time and click the update button.

RESULT: The straddle time (inter-frame gap) should now read 500 nano-seconds for the Phantom v710 and v12.1, 660 nano-seconds for the Phantom v310, 700 nano-seconds for the Phantom v210, 1.2 micro-seconds for the Phantom v640, and 1.5micro-seconds for the Phantom v10, v9.1, v7.3, and v5.2.



Vision Research cannot guarantee that camera synchronization can be achieved while performing this task due to the short straddle time.

Part



3 Back Focus Adjustments

Due to slight differences in the back focus distance of various lenses it may be necessary to adjust the lens mount on the camera to obtain proper focus at infinity. In most cases, changing a lens will not require adjusting the back focus. However, when a lens does not hold focus at both ends of the zoom range, you may need to adjust the back focus. By adjusting the back focus, you are changing the distance of between the flange and the sensor plane.

3.1 Phantom 65 , Phantom HD, Phantom Flex, Phantom Flex4K

Back Focus Kit Contents

The kit contains the following shim sizes:

- .0005 in.
- .001 in
- .05mm
- .1 mm
- .2 mm
- .3 mm
- .4mm
- .5mm
- 1mm
- 2mm

Equipment Needed

- Calibrator
- 7-64 inch hex wrench
- Properly collimated PL Mount lens (the wider the better)
- Tape measure
- Focus Target (ie, test chart)

STEP-BY-STEP PROCEDURE

Adjusting the Back Focus



The target should be for an unfiltered PL mount lens distance should be 52.00mm minus .02mm. A filtered PL mount lens distance should be 52.00mm plus approx. 1.75mm. Some manual adjust must be necessary for optimum flange distance.

A mount without any shims installed has a flange distance, the distance from the face of the mount to the image plane, of approximately 51.00mm.

1. Carefully remove the lens mount located on the front of the camera.
2. Determine if the installed filter is to remain installed:

- a. If yes: shim for an approximate distance of 53.75mm.
- b. If no: shim for 52.00mm minus .02mm.



The range of shim distance to be added to an unfiltered mount should be between .725mm and 1.725mm. The range of shim distance to be added to a filtered mount should be between 2.5mm and 3.5mm.

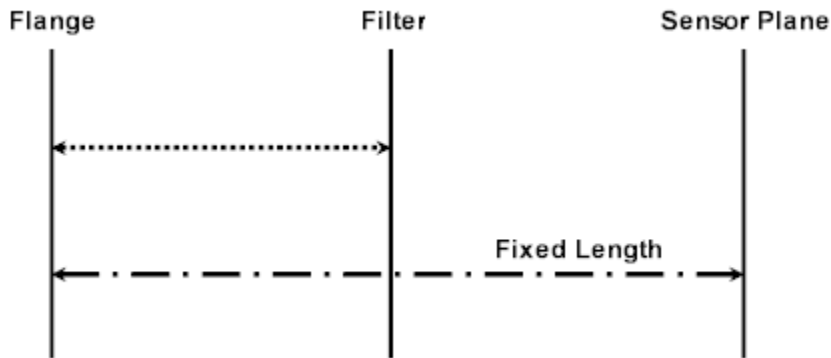

Arrows above indicate shim area:

- Short arrow with filter
 - Long arrow without filter
3. Place the shim between the mount and the camera housing.
 - a. For an unfiltered start with a total shim width of 1.25mm, for a filter start with a total shim width of 3mm .
 4. Reinstall the mount.
 5. Install the lens.
 6. Check lens focus at infinity.
 - a. If not focused, remove shims until focus is achieved.
 - b. If focused, set the lens to shortest focal length and check focus.
 - 1) If not focus add shims until focus is achieved.
 7. Repeat process until both infinity and shortest focal length are properly focused.

3.2 Phantom v-Series

Back Focus Kit Contents



The Back Focus Kit content is available from Vision Research, and is packaged only with purchase of PL-mount.

The kit contains the following shim sizes:

- .0005 in.
- .001 in
- .05mm
- .1 mm
- .2 mm

- .3 mm
- .4mm
- .5mm
- 1mm
- 2mm

Equipment Needed

- 9-64 inch hex wrench
- Standard Non-Zoom Nikon Lens
- Tape measure
- Focus Target (ie, some type of test chart)

STEP-BY-STEP PROCEDURE

Adjusting the Back Focus



The standard shim depth for all v-Series cameras is .70mm, made up of 4 shims 3 - .1mm, and 1-.05mm. Minor adjustments to the depth may be required to achieve a proper back focus. Each camera may vary slightly. Ensure the lens is set to the widest aperture before proceeding.

1. Check infinity focus by focusing beyond the infinity specification of the applied lens.
 - a. If the object is not sharply focused to infinity:
 - 1) Remove the lens mount.
 - 2) Remove .05mm shim.
 - 3) Re-install lens mount making sure that the lens mount is securely fastened and retest.
 - b. If still not focused repeat removing shims until focus is achieved.
 - c. If focused is achieved prior to setting to infinity, shims need to be added:
 - 1) Remove the lens mount.
 - 2) Add various size shims until focus is achieved.



The farther the focus point is to the infinity setting the thicker the shim(s) will be.

- d. If focused, adjust the lens to the shortest focus point and measure using the tape measure the minimum focus distance of the lens to the target.
- e. If not focused, repeat the complete process again.
- f. If focused, adjust the lens to medium focus point, approximately 10 feet, and measure using the tape measure the minimum focus distance of the lens to the target.
- g. If not focused, repeat the complete process again.



With the use of a zoom lens and object in focus at any distance should remain in focus when zooming in or out on a subject.

3.3 Phantom Miro Series

Equipment Needed

- 3-32 inch hex wrench
- 1" C-Mount lens or F-mount lens w/adaptor
- Tape measure
- Focus Target (ie, some type of test chart)

STEP-BY-STEP PROCEDURE

Adjusting the Back Focus



Ensure the lens is set to the widest aperture before proceeding.

1. One Back-focus adjustment screw is located under the camera and one on the right-hand side, as you look at it from the front of the camera.
2. Tightly attach a lens, (recommended lens are to use a fixed focus 6.5mm or 12.5mm lens), to the camera and set the focus ring to infinity.
3. Loosen the two Back-focus adjustment screws just enough to permit the C-Mount to turn inward and outward to and from the housing.
4. With the camera in Live Preview Mode and an image showing on the monitor or LCD display aim the camera at a subject at a distance greater than the maximum focus distance printed on the lens you are adjusting for.
5. Grasp the lens close to the camera being careful not to disturb the focusing ring and turn the lens mount inward or outward until the image on the monitor is sharp and then continue just past this point of focus until the image goes ever so slightly out of focus again.
6. Retighten the Back-focus adjustment screws and check the focus. When the adjustment is done properly, the lens will focus at a point just before the focusing ring reaches the end of its travel on the infinity end. By turning the focus ring a bit more the image will go out of focus thus passing through the infinity adjust point.

Part



4 Connectors, On-Camera Control, and Indicators

The connector references in this module are not intended, nor should they be used, as a cable schematic to build connection cables. Building your own cables can cause serious damage to the camera. Only connector cables provided by Vision Research should be used.



The connector references in this module are not intended, nor should they be used, as a cable schematic to build connection cables. Building your own cables can cause serious damage to the camera. Only connector cables provided by Vision Research should be used.

4.1 Current Cameras

Vision Research categorizes Phantom cameras as Current for cameras that are presently being manufactured or sold. These products receive full support from Vision Research, including, all development and new features. Service contracts are available for these products.

4.1.1 Phantom Flex Series

The current Phantom Flex Series cameras include: Phantom Flex4K, Flex4K-GS, and Flex.

4.1.1.1 Phantom Flex4K /Flex4K-GS

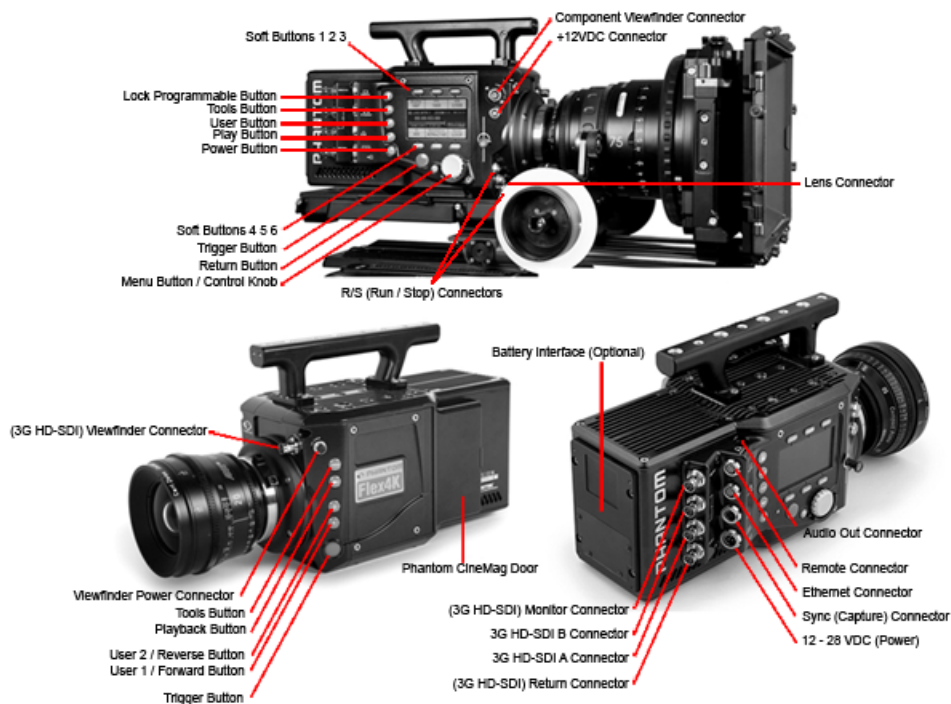

Click the link below for detail description:

- [Phantom 12 - 28VDC \(Power\) Connector](#)
- [Phantom +12VDC \(Auxiliary\) Connector](#)
- [Phantom 3G HD-SDI A / B Connectors](#)

- [Phantom 3G HD-SDI Monitor Connector](#)
- [Phantom \(3G HD-SDI\) Return Connector](#)
- [Phantom \(3G HD-SDI\) Viewfinder Connector](#)
- Phantom Audio Out Connector (still under construction)
- Phantom Battery Interface (self explanatory)
- Phantom CineMag Door (self explanatory)
- [Phantom Component Viewfinder Connector](#)
- [Phantom Ethernet Connector](#)
- Phantom Lens Connector (still under construction)
- [Phantom Remote Connector](#)
- [Phantom R/S \(Run / Stop\) Connector](#)
- [Phantom Sync \(Capture\) Connector](#)
- [Phantom Viewfinder Power Connector](#)
- [Phantom Flex4K On-Camera Control Buttons](#)
- [Phantom Flex4K Indicators](#)

4.1.1.2 Phantom Flex

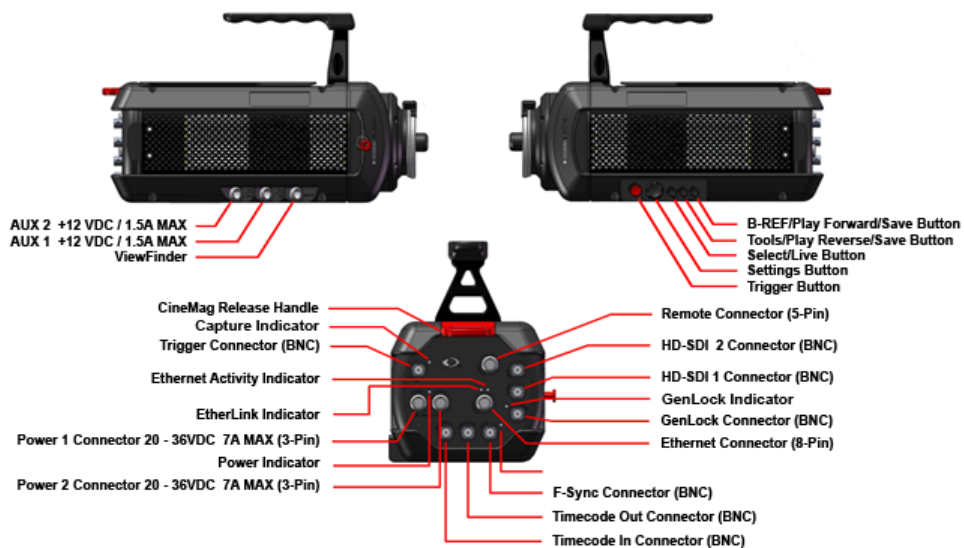

Click the link below for detail description:

- [Phantom Auxiliary Connector \(4-Pin Female\)](#)
- [Phantom Capture Connector \(Revision 4\) \(8-Pin Male\)](#)
- [Phantom F-SYNC Connector \(BNC\)](#)
- [Phantom GenLock Connector \(BNC\)](#)
- [Phantom Gigabit Ethernet Connector \(Revision 3\) \(8-Pin Female\)](#)

- [Phantom HD-SDI Connector \(BNC\)](#)
- [Phantom Power Connector \(3-Pin Male\)](#) Phantom Flex
- [Phantom Remote Connector \(5-Pin Female\)](#)
- [Phantom Trigger Connector \(BNC\)](#)
- [Phantom Timecode Connectors \(BNC\)](#)
- [Phantom ViewFinder Connector \(Revision 2\) \(7-Pin Female\)](#)
- [Phantom Flex On-Camera Control Buttons](#)
- [Phantom Flex Indicators](#)

4.1.2 Phantom UHS Series

The current Phantom Flex Series cameras include: Phantom v2640, v2512, v2012, v1612, v1212, v2511, v2011, v1611, and v1211.

4.1.2.1 Phantom UHS v2640

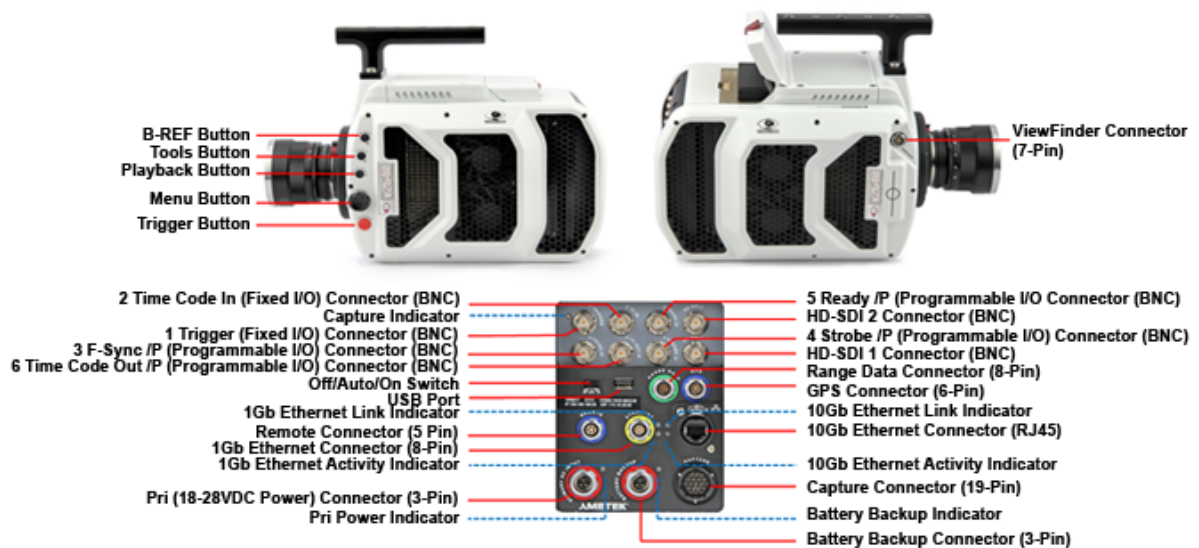

Click the link below for detail description:

- [Phantom Trigger Connector \(BNC\)](#)
- [Phantom TimeCode In Connector \(BNC\)](#)
- [Phantom Programmable I/O \(P3\) \(Default: F-Sync\) \(BNC\)](#)
- [Phantom Programmable I/O \(P4\) \(Default: Strobe\) \(BNC\)](#)
- [Phantom Programmable I/O \(P5\) \(Default: Ready\) \(BNC\)](#)
- [Phantom Programmable I/O \(P6\) \(Default: TimeCode Out\) \(BNC\)](#)
- [Phantom 10G Connector \(RJ-45\)](#)
- [Phantom Capture Connector \(Revision 4\) \(19-Pin Female\)](#)
- [Phantom F-SYNC Connector \(BNC\)](#)
- [Phantom GPS Connector \(6-Pin Male\)](#)

- [Phantom Gigabit Ethernet Connector \(Revision 3\) \(8-Pin Female\)](#)
- [Phantom HD-SDI Connector \(BNC\)](#)
- [Phantom Power Connector \(3-Pin Male\)](#)
- [Phantom Off/Auto/On Toggle Switch](#)
- [Phantom Range Data Connector \(8-Pin Male\)](#)
- [Phantom Remote Connector \(5-Pin Female\)](#)
- [Phantom ViewFinder Connector \(Revision 2\) \(7-Pin Female\)](#)
- Phantom USB Port (presently unused)
- [Phantom UHS v2640 On-Camera Control Buttons](#)
- [Phantom UHS v2640 Indicators](#)

4.1.2.2 Phantom UHS xx12 Series

The current Phantom UHS (Ultra-high Speed) Series cameras include: Phantom v2512, v2012, v1612, and v1212.

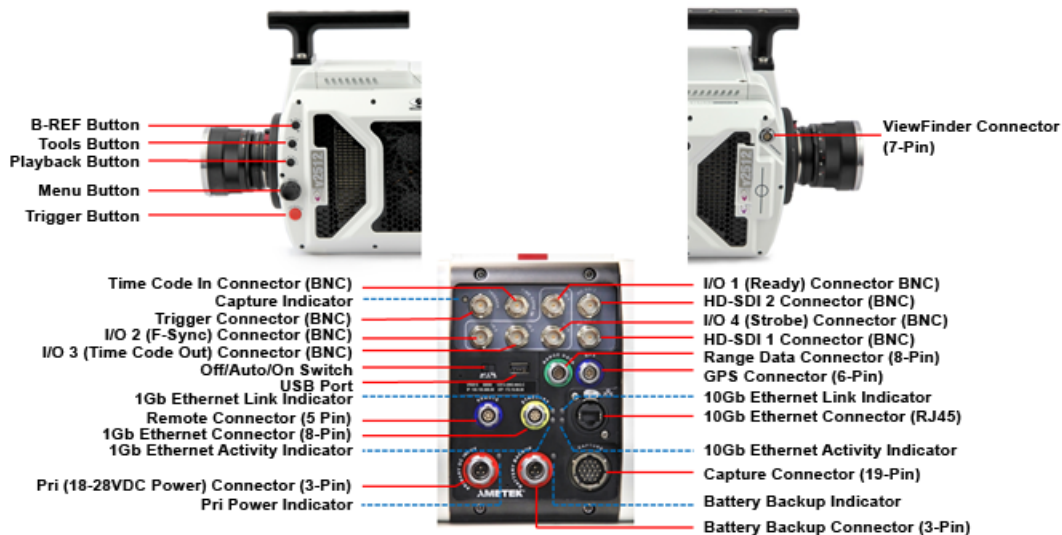

Click the link below for detail description:

- [Phantom 10G Connector \(RJ-45\)](#)
- [Phantom Capture Connector \(Revision 4\) \(19-Pin Female\)](#)
- [Phantom F-SYNC Connector \(BNC\)](#)
- [Phantom GPS Connector \(6-Pin Male\)](#)
- [Phantom Gigabit Ethernet Connector \(Revision 3\) \(8-Pin Female\)](#)
- [Phantom HD-SDI Connector \(BNC\)](#)
- [Phantom Power Connector \(3-Pin Male\)](#)
- [Phantom Off/Auto/On Toggle Switch](#)
- [Phantom Range Data Connector \(8-Pin Male\)](#)
- [Phantom Remote Connector \(5-Pin Female\)](#)

- [Phantom Trigger Connector \(BNC\)](#)
- [Phantom Timecode Connectors \(BNC\)](#)
- [Phantom ViewFinder Connector \(Revision 2\) \(7-Pin Female\)](#)
- Phantom USB Port (presently unused)
- [Phantom UHS Series On-Camera Control Buttons](#)
- [Phantom UHS Series Indicators](#)

4.1.2.3 Phantom UHS xx11 Series

The current Phantom UHS (Ultra-high Speed) Series cameras include: Phantom v2511, v2011, v1611, and v1211.

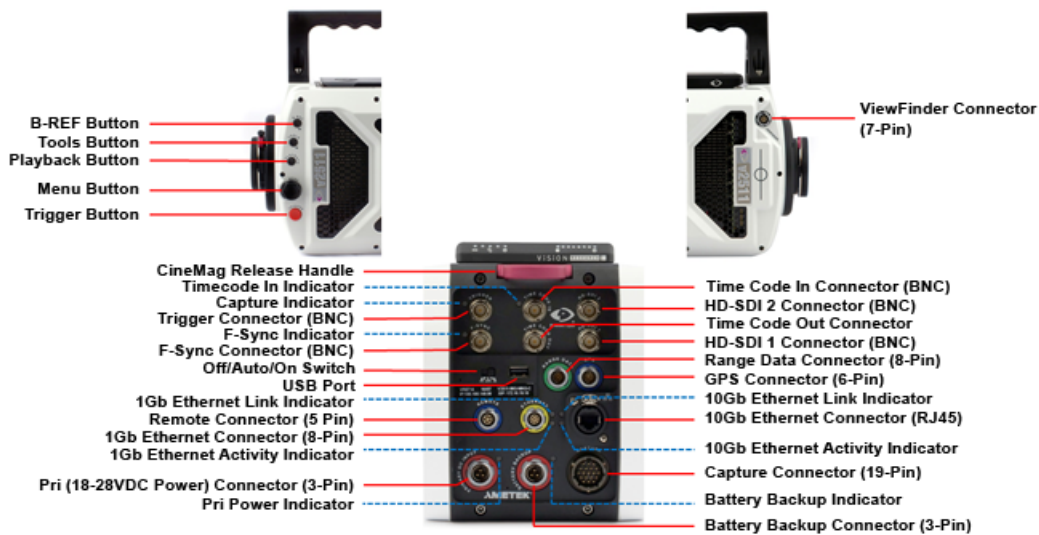

Click the link below for detail description:

- [Phantom 10G Connector \(RJ-45\)](#)
- [Phantom Capture Connector \(Revision 4\) \(19-Pin Female\)](#)
- [Phantom F-SYNC Connector \(BNC\)](#)
- [Phantom GPS Connector \(6-Pin Male\)](#)
- [Phantom Gigabit Ethernet Connector \(Revision 3\) \(8-Pin Female\)](#)
- [Phantom HD-SDI Connector \(BNC\)](#)
- [Phantom Power Connector \(3-Pin Male\)](#)
- [Phantom Off/Auto/On Toggle Switch](#)
- [Phantom Range Data Connector \(8-Pin Male\)](#)
- [Phantom Remote Connector \(5-Pin Female\)](#)
- [Phantom Trigger Connector \(BNC\)](#)
- [Phantom Timecode Connectors \(BNC\)](#)
- [Phantom ViewFinder Connector \(Revision 2\) \(7-Pin Female\)](#)
- Phantom USB Port (presently unused)

- [Phantom UHS Series On-Camera Control Buttons](#)
- [Phantom UHS Series Indicators](#)

4.1.3 Phantom VEO Series

The current Phantom VEO camera models include: VEO-S , VEO4K-S, VEO-L, VEO4K-L, and VEO4K-PL Series.

4.1.3.1 Phantom VEO / VEO4K L Series

The current Phantom VEO L Series cameras include: VEO 710L, VEO 410L, VEO 640L, VEO 340L, VEO4K 590L, and VEO4K 990L

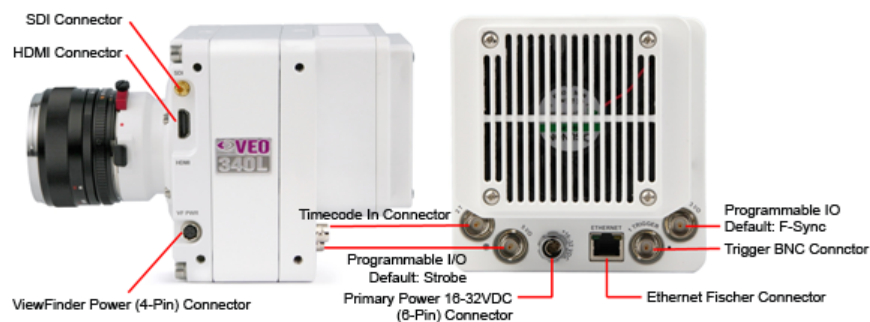

Click the link below for detail description:

- [Phantom Trigger Connector \(BNC\)](#)
- [Phantom TimeCode In Connector \(BNC\)](#)
- [Phantom Programmable I/O \(P3\) \(Default: F-Sync\) \(BNC\)](#)
- [Phantom Programmable I/O \(P5\) \(Default: Strobe\) \(BNC\)](#)
- [Phantom Gigabit Ethernet Connector \(RJ45\)](#)
- Phantom HD SDI Connector (DIN 1.0/2.3)
- [Phantom ViewFinder Power Connector \(4-Pin\)](#)
- [Phantom VEO Power Connector \(6-Pin\)](#)
- Standard HDMI Connector

4.1.3.2 Phantom VEO / VEO4K S / VEO4K-PL Series

The current Phantom VEO S Series cameras include: VEO 710S, VEO 410S, VEO 640S, VEO 340S, VEO 590S, VEO 990S. The VEO4K-PL Series utilizes the same connectors as the VEO S Series cameras.

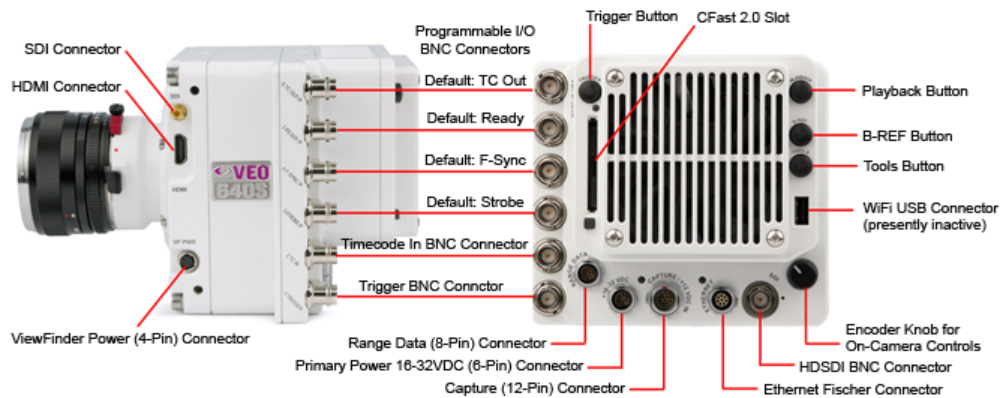

Click the link below for detail description:

- [Phantom Trigger Connector \(BNC\)](#)
- [Phantom TimeCode In Connector \(BNC\)](#)
- [Phantom Programmable I/O \(P3\) \(Default: Strobe\) \(BNC\)](#)
- [Phantom Programmable I/O \(P4\) \(Default: F-Sync\) \(BNC\)](#)
- [Phantom Programmable I/O \(P5\) \(Default: Ready\) \(BNC\)](#)
- [Phantom Programmable I/O \(P6\) \(Default: TimeCode Out\) \(BNC\)](#)
- [Phantom Range Data Connector \(8-Pin Male\)](#)
- [Phantom VEO Capture Connector \(12-Pin Male\)](#)
- Phantom HD SDI Connector (DIN 1.0/2.3)
- [Phantom ViewFinder Power Connector \(4-Pin\)](#)
- [Phantom VEO Power Connector \(6-Pin\)](#)
- [Phantom Gigabit Ethernet Connector \(Revision 3\) \(8-Pin Female\)](#)
- Phantom CFAST 2.0 Slot
- WiFi USB 2.0 Dongle Connector
- Standard HDMI Connector
- [Phantom VEO S Series On-Camera Control Buttons](#)
- Phantom VEO S Series Indicators

4.1.4 Phantom v-Series

The current Phantom v-Series cameras include: Phantom v642 Broadcast, v711, v641, v611, v411, and v341.



Click the link below for detail description:

- [Phantom Auxiliary Connector \(4-Pin Female\)](#)
- [Phantom Capture Connector \(Revision 3\) \(19-Pin Female\)](#)
- [Phantom F-SYNC Connector \(BNC\)](#)
- [Phantom Gigabit Ethernet Connector \(Revision 3\) \(8-Pin Female\)](#)
- [Phantom HD-SDI Connector \(BNC\)](#)
- [Phantom Power Connector \(3-Pin Male\)](#)
- [Phantom Range Data Connector \(8-Pin Male\)](#)
- [Phantom Remote Connector \(5-Pin Female\)](#)
- [Phantom Trigger Connector \(BNC\)](#)
- [Phantom Timecode Connectors \(BNC\)](#)
- [Phantom ViewFinder Connector \(Revision 2\) \(7-Pin Female\)](#)
- [Phantom v-Series On-Camera Control Buttons](#)
- [Phantom v-Series Indicators](#)

4.1.5 Phantom Miro M / R / LC Series

The current Phantom Miro M / R / LC Series cameras include: Miro M340, M320S, M310, M140, M120, M110, R320S, R310, R120, R110, LC320S, LC310, LC120, LC110.

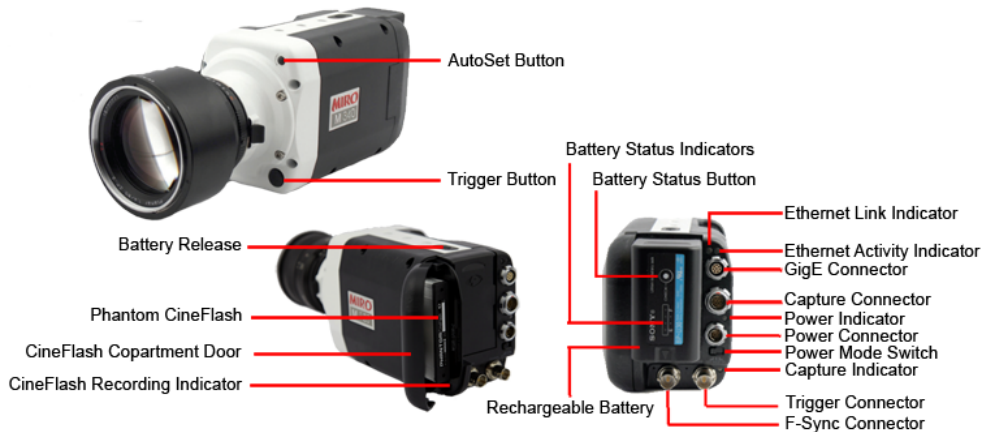

Click the link below for detail description:

- [Phantom F-SYNC Connector \(BNC\)](#)
- [Phantom Gigabit Ethernet Connector \(Revision 3\) \(8-Pin Female\)](#)
- [Phantom Miro M / R / LC Series Capture Connector \(12-Pin Male\)](#)
(M320s, M320, M120, M110, R320S, R310, R120, R110, LC310, LC110, LC320S, LC120)
- [Phantom Miro Mx40 Series Capture Connector \(12-Pin Male\)](#)
(Miro M340, M140)
- [Phantom Miro M / R / LC Series Power Connector \(Revision 2\) \(6-Pin Male\)](#)
(M320s, M320, M120, M110, R320S, R310, R120, R110, LC310, LC110, LC320S, LC120)
- [Phantom Miro Mx40 Series Power Connector \(6-Pin Male\)](#)
(Miro M340, M140)
- [Phantom Off/Auto/On Toggle Switch](#)
- [Phantom HD-SDI Connector \(BNC\)](#)
- [Phantom Miro M / R / LC Series On-Camera Control Buttons](#)
- [Phantom Miro M / R / LC Series Indicators](#)

4.1.6 Phantom Miro LAB Series

The current Phantom Miro LAB Series cameras include: Miro LAB110, LAB310, LAB3a10, LAB120, LAB320, LAB140, and LAB340.



Click the link below for detail description:

- [Phantom Gigabit Ethernet Connector \(RJ45\)](#)
- [Phantom Miro LAB Seies Power Connector \(6-Pin Male\)](#)
- [Phantom Miro LAB BNC Connectors](#)
- [Phantom Miro LAB On-Camera Control Buttons](#)
- [Phantom Miro LAB Indicators](#)

4.1.7 Phantom Miro C / N Series

The current Phantom Miro C Series cameras include: Miro C210 and C210J.

4.1.7.1 Phantom Miro C110



Click the link below for detail description:

- [Phantom Miro C110 Gigabit Ethernet Connector \(RJ-45\)](#)

- [Phantom Miro C110 Trigger, SDI, I/O-1, and I/O-2 Connectors \(BNC\)](#)
- [Phantom Miro C110 Power Connector \(3-Pin Male\)](#)
- [Phantom Trigger Connector \(BNC\)](#)
- [Phantom Miro C110 Indicators](#)

4.1.7.2 Phantom Miro C210

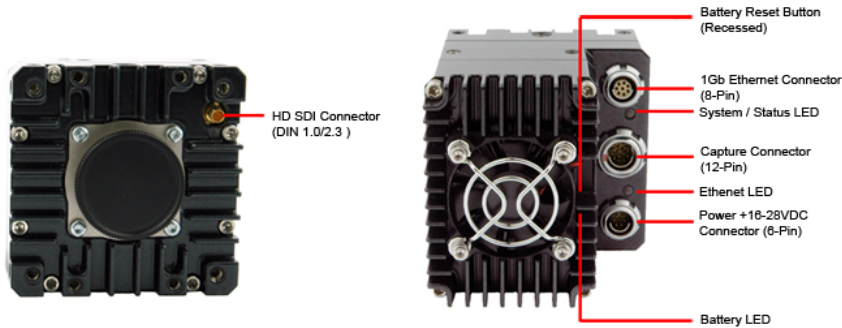

Click the link below for detail description:

- Phantom HD SDI Connector (DIN 1.0/2.3)
- Battery Reset Button
- [Phantom Gigabit Ethernet Connector \(Revision 3\) \(8-Pin Female\)](#)
- [Phantom Miro C210 Capture Connector \(12-Pin Male\)](#)
- [Phantom Miro C210 Power Connector \(6-Pin Male\)](#)
- [Phantom Miro C210 Indicators](#)

4.1.7.3 Phantom Miro C210J

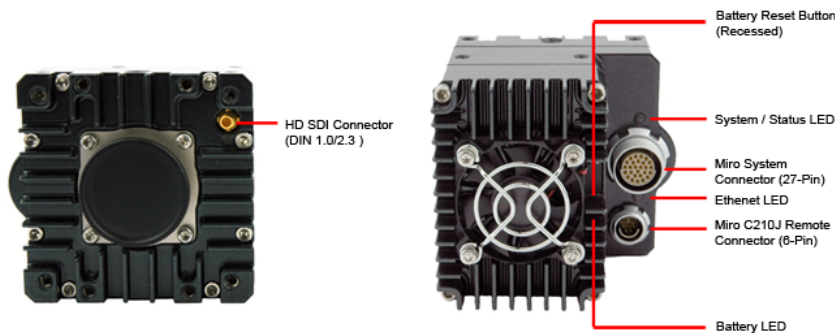

Click the link below for detail description:

- Phantom HD SDI Connector (DIN 1.0/2.3)
- Battery Reset Button
- [Phantom Miro C210J System Connector \(27-Pin\)](#)

- [Phantom Miro C210J Remote Connector \(6-Pin Male\)](#)
- [Phantom Miro C210J Indicators](#)

4.1.7.4 Phantom Miro N5 and N-JB (Junction Box)

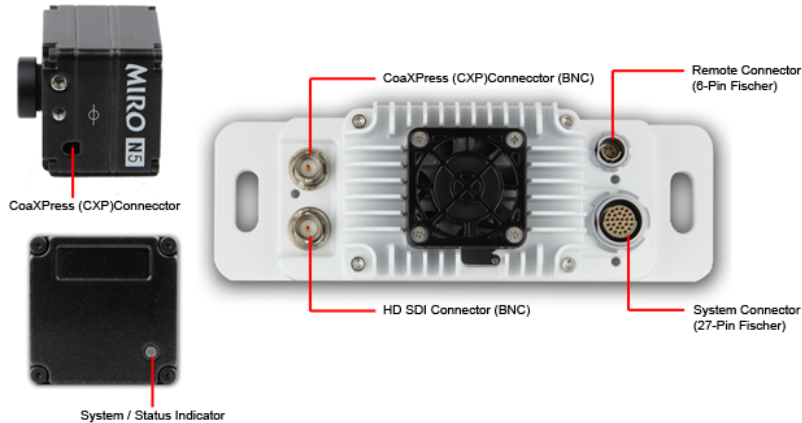

Click the link below for detail description:

- [Phantom Miro N5 CoaXPress \(CPX\) / HD SDI Connectors](#)
- [Phantom Miro N-JB CoaXPress \(CPX\) / HD SDI Connectors \(BNC\)](#)
- [Phantom Miro N-JB System Connector \(27-Pin Fischer\)](#)
- [Phantom Miro N-JB Remote Connector \(6-Pin Fischer\)](#)
- [Phantom Miro N5 Indicator](#)

4.1.8 Phantom Miro eX4



Click the link below for detail description:

- [Phantom Miro 10/100 Ethernet Connector \(8-Pin Female\)](#)
- [Phantom Miro CompactFlash™ Slot](#)
- [Phantom Miro eX4, Miro 3, and Miro Airborne/Airborne HD Capture Connector \(12-Pin Male\)](#)
- [Phantom Miro eX4 Power On/Trigger Button](#)

- [Phantom Miro Power Connector \(6-Pin Male\)](#)
- [Phantom Miro eX4 Indicators](#)

4.2 Discontinued Cameras

Vision Research categorizes Phantom cameras as Discontinued for cameras that are no longer being manufactured or sold, except as refurbished products. These products will continue to receive full support from Vision Research for 5 years. However, all development has stopped and no new features will be added. Service contracts will continue to be available for terms that do not extend into the obsolescence of the products in 5 years.

4.2.1 Phantom 65

Discontinued Date: 15-Apr-2013 Obsolete Date: 14-Apr-2018

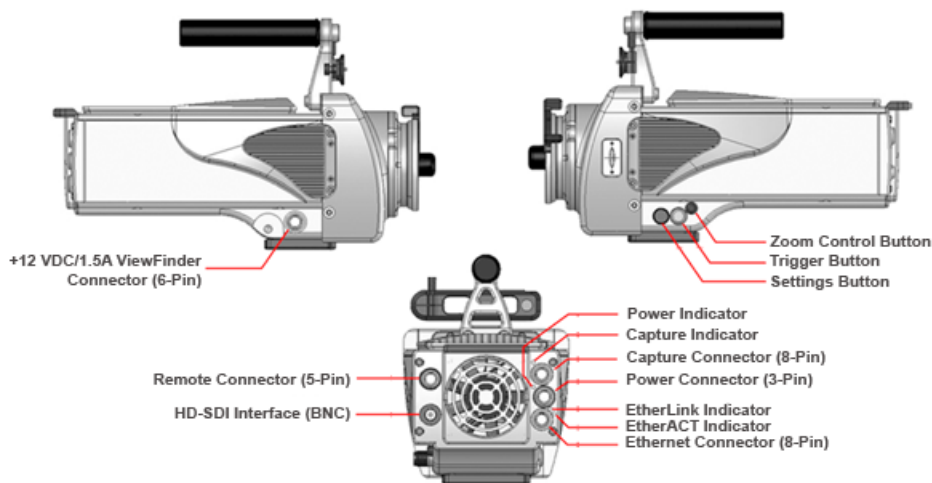

Click the link below for detail description:

- [Phantom Capture Connector \(Revision 4\) \(8-Pin Male\)](#)
- [Phantom Gigabit Ethernet Connector \(Revision 3\) \(8-Pin Female\)](#)
- [Phantom HD-SDI Connector \(BNC\)](#)
- [Phantom Power Connector \(3-Pin Male\)](#)
- [Phantom Remote Connector \(5-Pin Female\)](#)
- [Phantom ViewFinder Connector \(Revision 2\) \(7-Pin Female\)](#)
- [Phantom 65 On-Camera Control Buttons](#)
- [Phantom 65 Indicators](#)

4.2.2 Phantom UHS xx10 Series

The discontinued Phantom HD Series cameras include:

CAMERA MODEL	DISCONTINUED DATE	OBSOLETE DATE
Phantom v2010	31-Dec-2014	31-Dec-2019
Phantom v1610	31-Dec-2014	31-Dec-2019
Phantom v1210	31-Dec-2014	31-Dec-2019

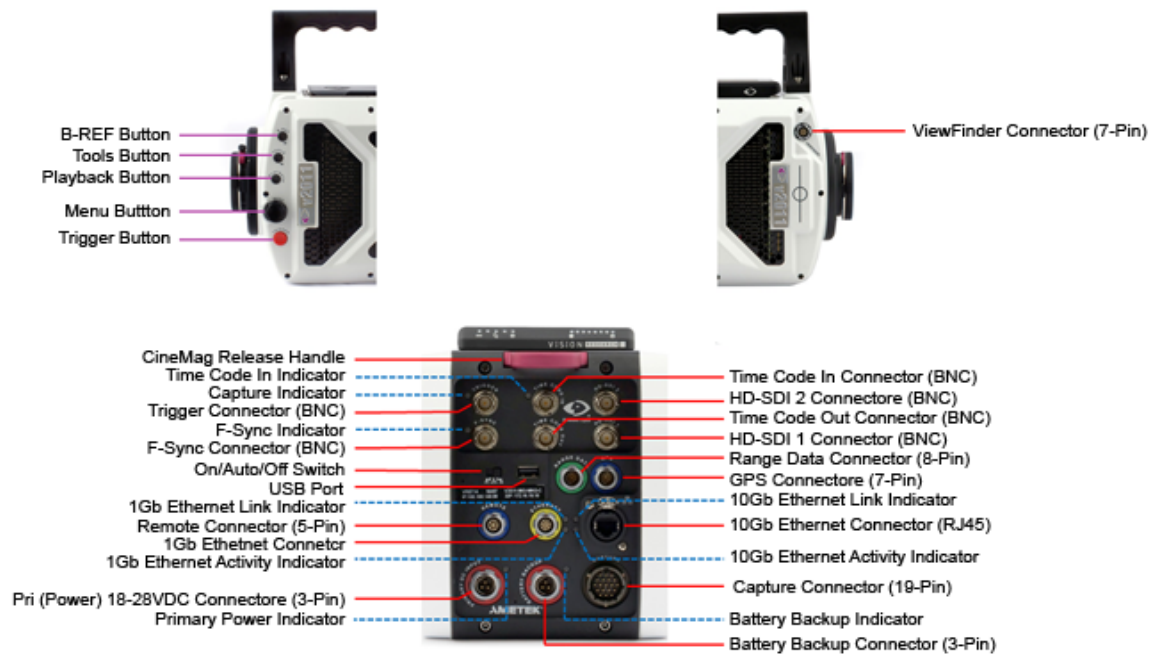

Click the link below for detail description:

- [Phantom 10G Connector \(RJ-45\)](#)
- [Phantom Capture Connector \(Revision 4\) \(19-Pin Female\)](#)
- [Phantom F-SYNC Connector \(BNC\)](#)
- [Phantom GPS Connector \(6-Pin Male\)](#)
- [Phantom Gigabit Ethernet Connector \(Revision 3\) \(8-Pin Female\)](#)
- [Phantom HD-SDI Connector \(BNC\)](#)
- [Phantom Power Connector \(3-Pin Male\)](#)
- [Phantom Off/Auto/On Toggle Switch](#)
- [Phantom Range Data Connector \(8-Pin Male\)](#)
- [Phantom Remote Connector \(5-Pin Female\)](#)
- [Phantom Trigger Connector \(BNC\)](#)
- [Phantom Timecode Connectors \(BNC\)](#)
- [Phantom ViewFinder Connector \(Revision 2\) \(7-Pin Female\)](#)
- Phantom USB Port (Not Used)
- [Phantom UHS xx11 On-Camera Control Buttons](#)

- [Phantom v2010 Indicators](#)

4.2.3 Phantom Vx11 Series

The discontinued Phantom Vx11 Series cameras include:

CAMERA MODEL	DISCONTINUED DATE	OBSOLETE DATE
Phantom v311	14-Apr-2014	14-Apr-2019
Phantom v211	04-Apr-2014	04-Apr-2019



Click the link below for detail description:

- [Phantom Auxiliary Connector \(4-Pin Female\)](#)
- [Phantom Capture Connector \(Revision 3\) \(19-Pin Female\)](#)
- [Phantom F-SYNC Connector \(BNC\)](#)
- [Phantom Gigabit Ethernet Connector \(Revision 3\) \(8-Pin Female\)](#)
- [Phantom HD-SDI Connector \(BNC\)](#)
- [Phantom Power Connector \(3-Pin Male\)](#)
- [Phantom Range Data Connector \(8-Pin Male\)](#)
- [Phantom Remote Connector \(5-Pin Female\)](#)
- [Phantom Trigger Connector \(BNC\)](#)
- [Phantom Timecode Connectors \(BNC\)](#)
- [Phantom ViewFinder Connector \(Revision 2\) \(7-Pin Female\)](#)
- [Phantom Vx11 Series On-Camera Control Buttons](#)
- [Phantom Vx11 Series Indicators](#)

4.2.4 Phantom Legacy v-Series

The discontinued Phantom Legacy v-Series cameras include:

4.2.5 Phantom v7.3

Discontinued Date: 14-August-2014 Obsolete Date: 14-August-2019



Click the link below for detail description:

- [Phantom Capture Connector \(Revision 2\) \(19-Pin Male\)](#)
- [Phantom Gigabit Ethernet Connector \(Revision 1\) \(8-Pin Male\)](#)
- [Phantom HD-SDI Connector \(BNC\)](#)
- [Phantom Power Connector \(4-Pin Male\)](#)
- [Phantom RTO Fiber Optic Connector](#)
- [Phantom ViewFinder Connector \(Revision 1\) \(7-Pin Female\)](#)
- [Phantom v7.3 Indicators](#)

4.2.6 Phantom ir300

Discontinued Date: 15-Oct-2014 Obsolete Date: 15-Oct-2019



Click the link below for detail description:

- [Phantom Capture Connector \(Revision 2\) \(19-Pin Male\)](#)
- [Phantom Gigabit Ethernet Connector \(Revision 1\) \(8-Pin Male\)](#)
- [Phantom HD-SDI Connector \(BNC\)](#)
- [Phantom Power Connector \(4-Pin Male\)](#)
- [Phantom RTO Fiber Optic Connector](#)
- [Phantom ViewFinder Connector \(Revision 1\) \(7-Pin Female\)](#)
- [Phantom ir300 Indicators](#)

4.2.7 Phantom Miro Airborne Series

The discontinued Phantom Miro Airborne Series cameras include:

CAMERA MODEL	DISCONTINUED DATE	OBSOLETE DATE
Phantom Miro Airborne HD	10-Jul-2015	10-Jul-2020
Phantom Miro Airborne	10-Jul-2015	10-Jul-2020



Click the link below for detail description:

- [Phantom Miro 10/100 Ethernet Connector \(8-Pin Female\)](#)
- [Phantom Miro CompactFlash™ Slot](#)

- [Phantom Miro eX4, Miro 4, Miro 3, and Miro Airborne/AirborneHD Capture Connector \(12-Pin Male\)](#)
- [Phantom Miro Power Connector \(6-Pin Male\)](#)
- [Phantom Miro Airborne Series Indicators](#)

4.2.8 Phantom Miro eX3

Discontinued Date: 18-Feb-2015 Obsolete Date: 17-Feb-2020



Click the link below for detail description:

- [Phantom Miro 10/100 Ethernet Connector \(8-Pin Female\)](#)
- [Phantom Miro CompactFlash™ Slot](#)
- [Phantom Miro eX4, Miro 3, and Miro Airborne/Airborne HD Capture Connector \(12-Pin Male\)](#)
- [Phantom Miro eX2 Capture Connector \(12-Pin Male\)](#)
- [Phantom Miro eX1 Capture Connector \(12-Pin Male\)](#)
- [Phantom Miro eX Series Power On/Trigger Button](#)
- [Phantom Miro Power Connector \(6-Pin Male\)](#)
- [Phantom Miro eX Series Indicators](#)

4.2.9 Phantom Miro 3

Discontinued Date: 10-Jul-2015 Obsolete Date: 10-Jul-2020



Click the link below for detail description:

- [Phantom Miro 10/100 Ethernet Connector \(8-Pin Female\)](#)
- [Phantom Miro eX4, Miro 4, Miro 3, and Miro Airborne/Airborne HD Capture Connector \(12-Pin Male\)](#)
- [Phantom Miro Power Connector \(6-Pin Male\)](#)
- [Phantom Miro 3 Indicators](#)

4.3 Obsolete Cameras

Vision Research categorizes Phantom cameras as Obsolete for cameras that are no longer being manufactured or sold. These products no longer receive full support from Vision Research. All development has stopped and no new features will be added. No service contracts will available.

4.3.1 Phantom HD Series

The discontinued Phantom HD Series cameras include:

CAMERA MODEL	OBSOLETE DATE
Phantom HD Gold	31-Dec-2016
Phantom HD	31-Dec-2016

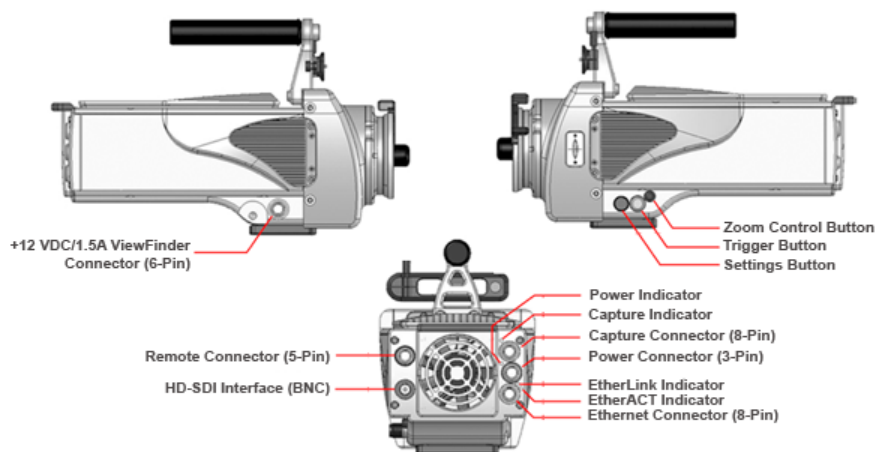

Click the link below for detail description:

- [Phantom Capture Connector \(Revision 4\) \(8-Pin Male\)](#)
- [Phantom Gigabit Ethernet Connector \(Revision 3\) \(8-Pin Female\)](#)
- [Phantom HD-SDI Connector \(BNC\)](#)
- [Phantom Power Connector \(3-Pin Male\)](#)
- [Phantom Remote Connector \(5-Pin Female\)](#)

- [Phantom ViewFinder Connector \(Revision 2\) \(7-Pin Female\)](#)
- [Phantom HD Series On-Camera Control Buttons](#)
- [Phantom HD Series Indicators](#)

4.3.2 Phantom v640

Obsolete Date: 07-Sept-2016

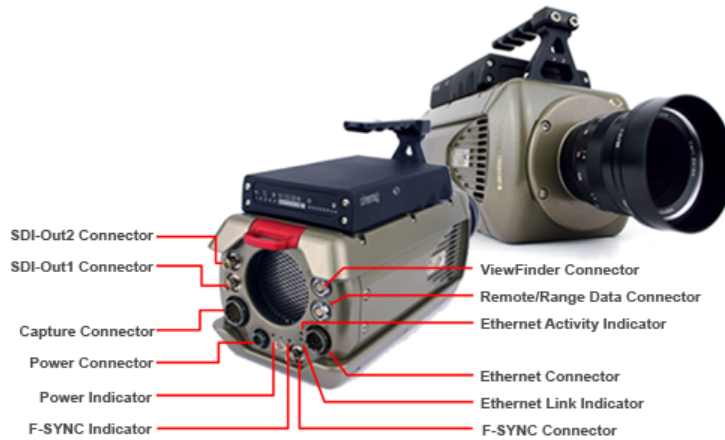

Click the link below for detail description:

- [Phantom Capture Connector \(Revision 3\) \(19-Pin Male\)](#)
- [Phantom F-SYNC Connector \(BNC\)](#)
- [Phantom Gigabit Ethernet Connector \(Revision 2\) \(8-Pin Male\)](#)
- [Phantom HD-SDI Connector \(BNC\)](#)
- [Phantom Power Connector \(4-Pin Male\)](#)
- [Phantom Remote/Range Data Connector \(8-Pin Female\)](#)
- [Phantom ViewFinder Connector \(Revision 2\) \(7-Pin Female\)](#)
- [Phantom v640 Indicators](#)

4.3.3 Phantom Vx10 Series

The discontinued Phantom Vx10 Series cameras include:

CAMERA MODEL	OBSOLETE DATE
Phantom v710	07-Sept-2016
Phantom v310	07-Sept-2016
Phantom v210	07-Sept-2016

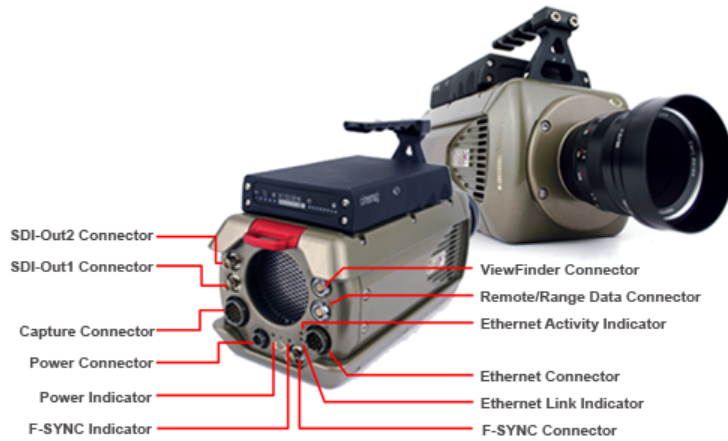

Click the link below for detail description:

- [Phantom Capture Connector \(Revision 3\) \(19-Pin Male\)](#)
- [Phantom F-SYNC Connector \(BNC\)](#)
- [Phantom Gigabit Ethernet Connector \(Revision 2\) \(8-Pin Male\)](#)
- [Phantom HD-SDI Connector \(BNC\)](#)
- [Phantom Power Connector \(4-Pin Male\)](#)
- [Phantom Remote/Range Data Connector \(8-Pin Female\)](#)
- [Phantom ViewFinder Connector \(Revision 2\) \(7-Pin Female\)](#)
- [Phantom Vx10 Series Indicators](#)

4.3.4 Phantom Legacy Series

4.3.4.1 Phantom v12.1

Obsolete Date: 07-Sept-2016

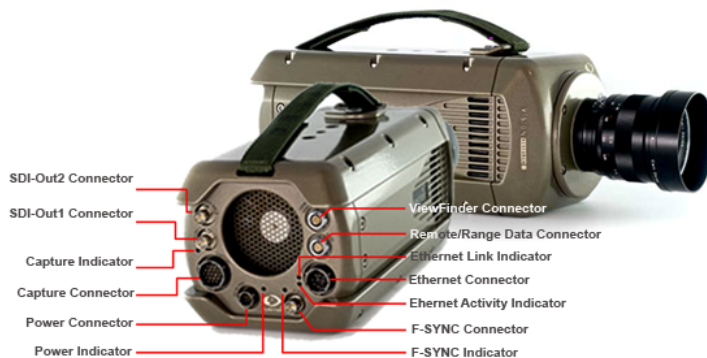

Click the link below for detail description:

- [Phantom Capture Connector \(Revision 3\) \(19-Pin Male\)](#)
- [Phantom F-SYNC Connector \(BNC\)](#)
- [Phantom Gigabit Ethernet Connector \(Revision 2\) \(8-Pin Male\)](#)
- [Phantom HD-SDI Connector \(BNC\)](#)
- [Phantom Power Connector \(4-Pin Male\)](#)
- [Phantom Remote/Range Data Connector \(8-Pin Female\)](#)
- [Phantom ViewFinder Connector \(Revision 2\) \(7-Pin Female\)](#)
- [Phantom v12.1 Indicators](#)

4.3.4.2 Phantom v12.0

Obsolete Date: 30-Dec-2011

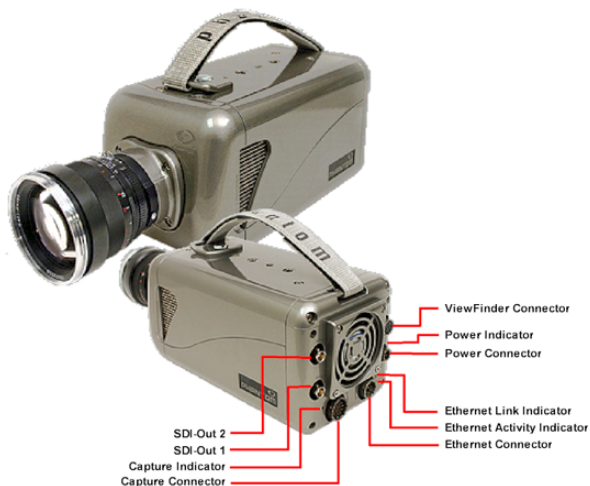

Click the link below for detail description:

- [Phantom Capture Connector \(Revision 2\) \(19-Pin Male\)](#)
- [Phantom Gigabit Ethernet Connector \(Revision 1\) \(8-Pin Male\)](#)
- [Phantom HD-SDI Connector \(BNC\)](#)
- [Phantom Power Connector \(4-Pin Male\)](#)
- [Phantom ViewFinder Connector \(Revision 2\) \(7-Pin Female\)](#)
- [Phantom v12,0 Indicators](#)

4.3.4.3 Phantom v10

Obsolete Date: 30-June-2017



Click the link below for detail description:

- [Phantom Capture Connector \(Revision 2\) \(19-Pin Male\)](#)
- [Phantom Gigabit Ethernet Connector \(Revision 1\) \(8-Pin Male\)](#)
- [Phantom HD-SDI Connector \(BNC\)](#)
- [Phantom Power Connector \(4-Pin Male\)](#)
- [Phantom RTO Fiber Optic Connector](#)
- [Phantom ViewFinder Connector \(Revision 1\) \(7-Pin Female\)](#)
- [Phantom v10 Indicators](#)

4.3.4.4 Phantom v9.1

Obsolete Date: 30-June-2017



Click the link below for detail description:

- [Phantom Capture Connector \(Revision 2\) \(19-Pin Male\)](#)
- [Phantom Gigabit Ethernet Connector \(Revision 1\) \(8-Pin Male\)](#)
- [Phantom HD-SDI Connector \(BNC\)](#)

- [Phantom Power Connector \(4-Pin Male\)](#)
- [Phantom RTO Fiber Optic Connector](#)
- [Phantom ViewFinder Connector \(Revision 1\) \(7-Pin Female\)](#)
- [Phantom v9.1 Indicators](#)

4.3.4.5 Phantom v9.0

Obsolete Date: 27-May-2012



Click the link below for detail description:

- [Phantom Capture Connector \(Revision 1\) \(19-Pin Male\)](#)
- [Phantom Gigabit Ethernet Connector \(Revision 1\) \(8-Pin Male\)](#)
- [Phantom Power Connector \(4-Pin Male\)](#)
- [Phantom Range Data Connector \(6-Pin Male\)](#)
- [Phantom RTO Fiber Optic Connector](#)
- [Phantom v9.0 Indicators](#)

4.3.4.6 Phantom v7.2

Obsolete Date: 26-May-2012

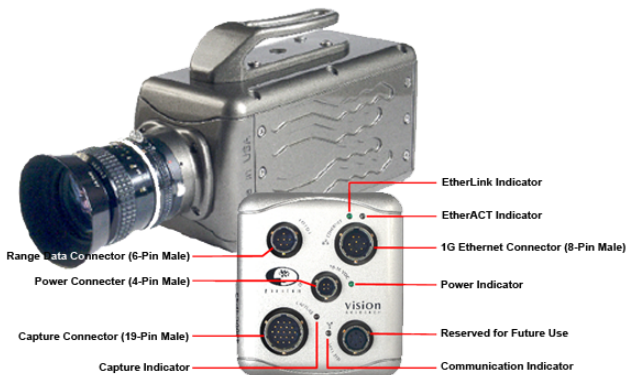

Click the link below for detail description:

- [Phantom Capture Connector \(Revision 1\) \(19-Pin Male\)](#)

- [Phantom Gigabit Ethernet Connector \(Revision 1\) \(8-Pin Male\)](#)
- [Phantom Power Connector \(4-Pin Male\)](#)
- [Phantom Range Data Connector \(6-Pin Male\)](#)
- [Phantom v7.2 Indicators](#)

4.3.4.7 Phantom v7.1

Obsolete Date: 26-May-2012

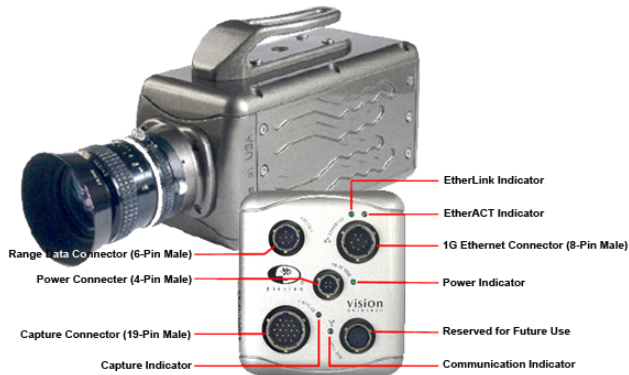

Click the link below for detail description:

- [Phantom Capture Connector \(Revision 1\) \(19-Pin Male\)](#)
- [Phantom Gigabit Ethernet Connector \(Revision 1\) \(8-Pin Male\)](#)
- [Phantom Power Connector \(4-Pin Male\)](#)
- [Phantom Range Data Connector \(6-Pin Male\)](#)
- [Phantom v7.1 Indicators](#)

4.3.4.8 Phantom v7.0g

Obsolete Date: 26-May-2010

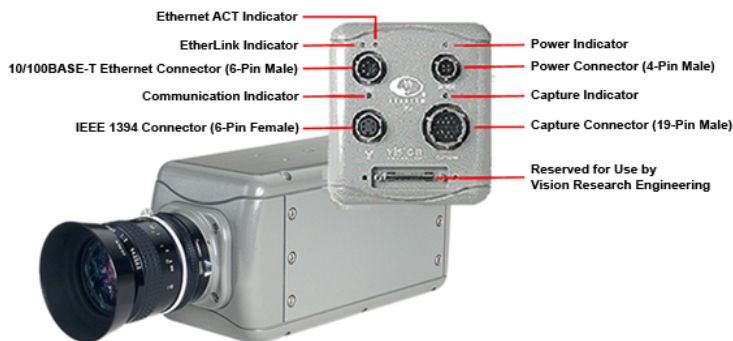

Click the link below for detail description:

- [Phantom 10/100 Ethernet Connector \(8-Pin Male\)](#)
- [Phantom Capture Connector \(Revision 1\) \(19-Pin Male\)](#)

- [Phantom Power Connector \(4-Pin Male\)](#)
- [Phantom Range Data Connector \(6-Pin Male\)](#)
- [Phantom v7.0g Indicators](#)

4.3.4.9 Phantom v6.2e

Obsolete Date: 23-Oct-2010

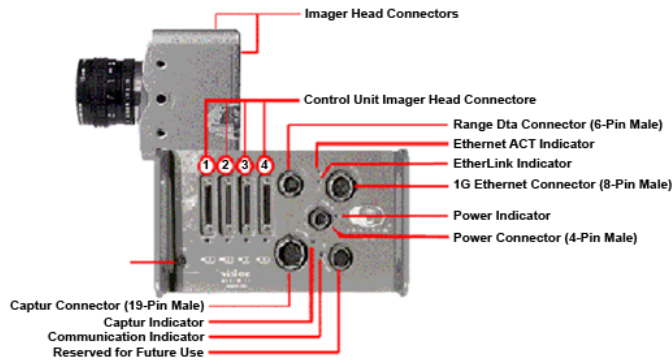

Click the link below for detail description:

- [Phantom Capture Connector \(Revision 2\) \(19-Pin Male\)](#)
- [Phantom Gigabit Ethernet Connector \(Revision 1\) \(8-Pin Male\)](#)
- [Phantom Power Connector \(4-Pin Male\)](#)
- [Phantom Range Data Connector \(6-Pin Male\)](#)
- [Phantom v6.2e Imager Head Connectors and Indicators](#)

4.3.4.10 Phantom v6.1

Obsolete Date: 23-Oct-2010

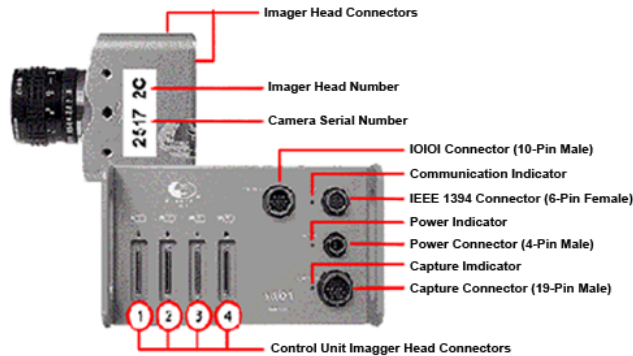

Click the link below for detail description:

- [Phantom Capture Connector \(Revision 1\) \(19-Pin Male\)](#)
- [Phantom IEEE 1394 Connector \(6-Pin Female\)](#)
- [Phantom IOIO Connector \(10-Pin Male\)](#)
- [Phantom Power Connector \(4-Pin Male\)](#)

- [Phantom v6.1 Imager Head Connectors and Indicators](#)

4.3.4.11 Phantom v6.0

Obsolete Date: 23-Oct-2010

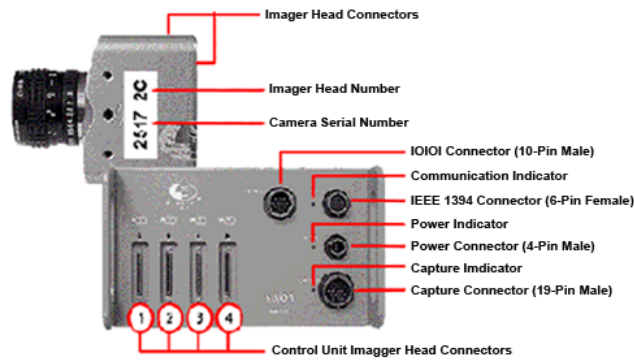

Click the link below for detail description:

- [Phantom Capture Connector \(Revision 1\) \(19-Pin Male\)](#)
- [Phantom IEEE 1394 Connector \(6-Pin Female\)](#)
- [Phantom IOIO Connector \(10-Pin Male\)](#)
- [Phantom Power Connector \(4-Pin Male\)](#)
- [Phantom v6.0 Imager Head Connectors and Indicators](#)

4.3.4.12 Phantom v5.2

Obsolete Date: 22-Aug-2014



Click the link below for detail description:

- [Phantom Capture Connector \(Revision 2\) \(19-Pin Male\)](#)
- [Phantom Gigabit Ethernet Connector \(Revision 1\) \(8-Pin Male\)](#)
- [Phantom HD-SDI Connector \(BNC\)](#)
- [Phantom Power Connector \(4-Pin Male\)](#)

- [Phantom RTO Fiber Optic Connector](#)
- [Phantom ViewFinder Connector \(Revision 1\) \(7-Pin Female\)](#)
- [Phantom v5.2 Indicators](#)

4.3.4.13 Phantom v5.1

Obsolete Date: 18-Feb-2013

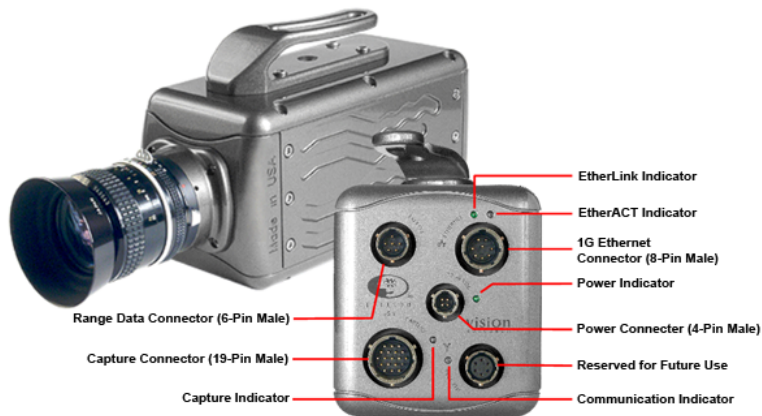

Click the link below for detail description:

- [Phantom Capture Connector \(Revision 2\) \(19-Pin Male\)](#)
- [Phantom Gigabit Ethernet Connector \(Revision 1\) \(8-Pin Male\)](#)
- [Phantom Power Connector \(4-Pin Male\)](#)
- [Phantom Range Data Connector \(6-Pin Male\)](#)
- [Phantom v5.1 Indicators](#)

4.3.4.14 Phantom v5.0

Obsolete Date: 18-Jun-2010

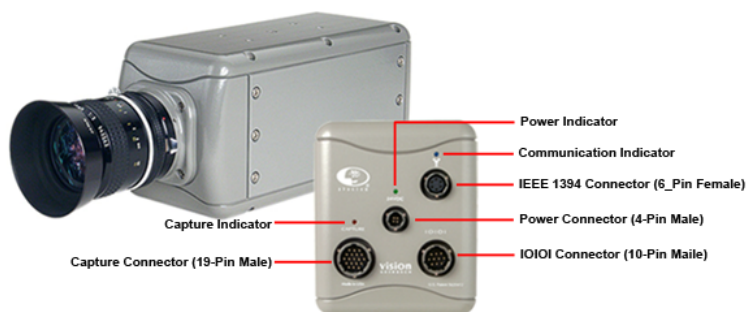

Click the link below for detail description:

- [Phantom Capture Connector \(Revision 1\) \(19-Pin Male\)](#)
- [Phantom IEEE 1394 Connector \(6-Pin Female\)](#)
- [Phantom IOIO Connector \(10-Pin Male\)](#)

- [Phantom Power Connector \(4-Pin Male\)](#)
- [Phantom v5.0 Indicators](#)

4.3.4.15 Phantom v4.3

Obsolete Date: 31-Mar-2011



Click the link below for detail description:

- [Phantom Capture Connector \(Revision 1\) \(19-Pin Male\)](#)
- [Phantom Gigabit Ethernet Connector \(Revision 1\) \(8-Pin Male\)](#)
- [Phantom Power Connector \(4-Pin Male\)](#)
- [Phantom v4.3 Indicators](#)

4.3.4.16 Phantom v4.2

Obsolete Date: 31-Mar-2011

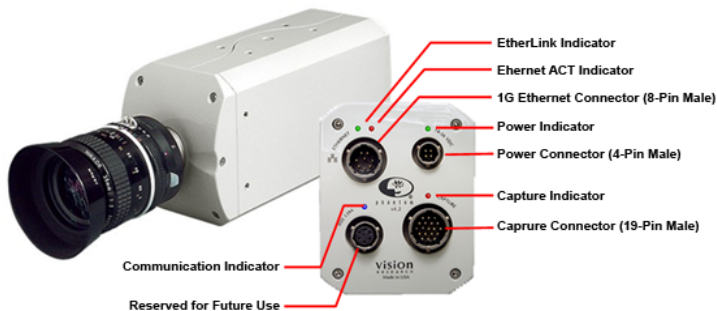

Click the link below for detail description:

- [Phantom Capture Connector \(Revision 1\) \(19-Pin Male\)](#)
- [Phantom Gigabit Ethernet Connector \(Revision 1\) \(8-Pin Male\)](#)
- [Phantom Power Connector \(4-Pin Male\)](#)
- [Phantom v4.2 Indicators](#)

4.3.4.17 Phantom v4.1

Obsolete Date: 18-Jun-2010



Click the link below for detail description:

- [Phantom IEEE 1394 Connector \(6-Pin Female\)](#)
- [Phantom IEEE 1394 Daisy Chain Connector](#)
- [Phantom v4.1 Power/Capture Connector \(19-Pin Male\)](#)
- [Phantom v4.1 Indicators](#)

4.3.5 Phantom Miro eX Series

The discontinued Phantom Miro eX Series cameras include:

CAMERA MODEL	DISCONTINUED DATE	OBSOLETE DATE
Phantom Miro eX3	14-Nov-2011	14-Nov-2016
Phantom Miro eX1	14-Nov-2011	14-Nov-2016



Click the link below for detail description:

- [Phantom Miro 10/100 Ethernet Connector \(8-Pin Female\)](#)
- [Phantom Miro CompactFlash™ Slot](#)
- [Phantom Miro eX4, Miro 3, and Miro Airborne/Airborne HD Capture Connector \(12-Pin Male\)](#)
- [Phantom Miro eX2 Capture Connector \(12-Pin Male\)](#)
- [Phantom Miro eX1 Capture Connector \(12-Pin Male\)](#)
- [Phantom Miro eX Series Power On/Trigger Button](#)

- [Phantom Miro Power Connector \(6-Pin Male\)](#)
- [Phantom Miro eX Series Indicators](#)

4.3.6 Phantom Miro Series

4.3.6.1 Phantom Miro 4

Obsolete Date: 09-Feb-2015



Click the link below for detail description:

- [Phantom Miro 10/100 Ethernet Connector \(8-Pin Female\)](#)
- [Phantom Miro CompactFlash™ Slot](#)
- [Phantom Miro 4 Capture Connector \(12-Pin Male\)](#)
- [Phantom Miro 4 Power On/Trigger Button](#)
- [Phantom Miro Power Connector \(6-Pin Male\)](#)
- [Phantom Miro 4 Indicators](#)

4.3.6.2 Phantom Miro 2

Obsolete Date: 09-Feb-2015



Click the link below for detail description:

- [Phantom Miro 10/100 Ethernet Connector \(8-Pin Female\)](#)
- [Phantom Miro CompactFlash™ Slot](#)

- [Phantom Miro 2 Capture Connector \(12-Pin Male\)](#)
- [Phantom Miro 2 Power On/Trigger Button](#)
- [Phantom Miro Power Connector \(6-Pin Male\)](#)
- [Phantom Miro 2 Indicators](#)

4.3.6.3 Phantom Miro 1

Obsolete Date: 09-Feb-2015



Click the link below for detail description:

- [Phantom Miro 10/100 Ethernet Connector \(8-Pin Female\)](#)
- [Phantom Miro CompactFlash™ Slot](#)
- [Phantom Miro 1 Capture Connector \(12-Pin Male\)](#)
- [Phantom Miro 1 Power On/Trigger Button](#)
- [Phantom Miro Power Connector \(6-Pin Male\)](#)
- [Phantom Miro 1 Indicators](#)

4.4 Peripherals

4.4.1 Phantom Break Out Box

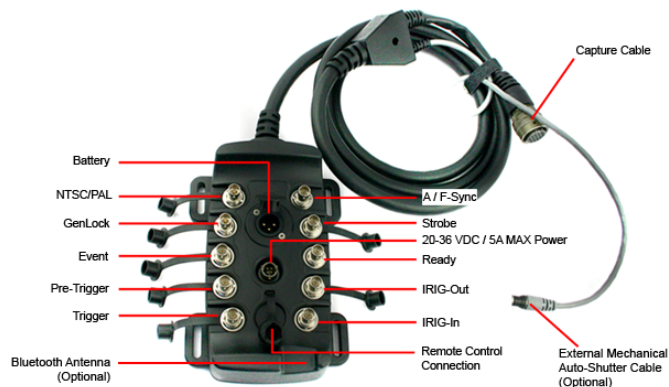

Click the link below for detail description:

- [Phantom Breakout Box Connectors](#)

4.4.2 Phantom Miro Mini Break Out Box

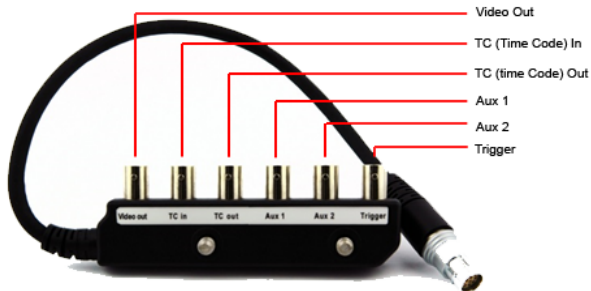

Click the link below for detail description:

- [Phantom Mini Breakout Box Connectors](#)

4.4.3 Phantom Miro Junction Box

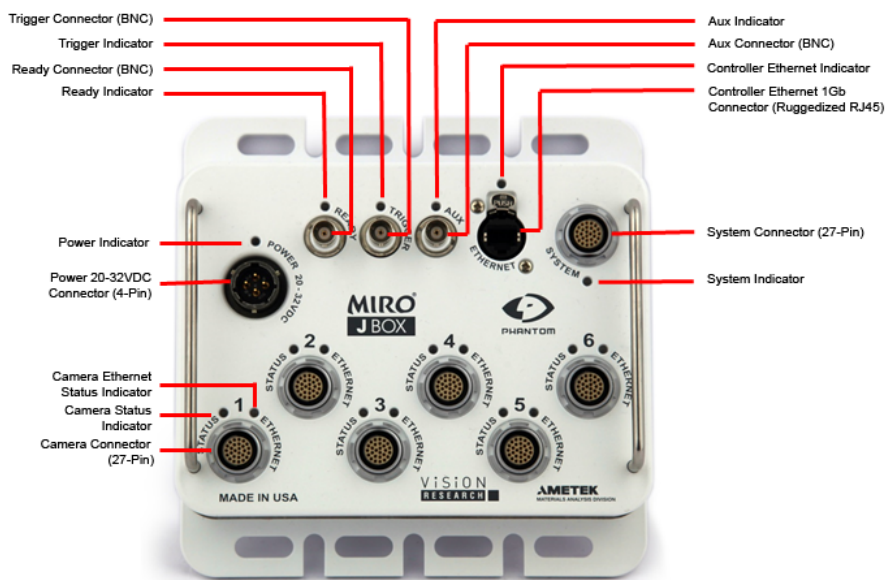

Click the link below for detail description:

- [Phantom Mini Junction Box Connectors](#)

4.4.4 Phantom CineMag IV



For details refer to [Phantom CineMag IV Indicators](#)

4.4.5 Phantom CineMag II

The Phantom CineMag consist of two groups of indicators. A group of five indicators on the rear-left of the unit, from left to right, Power, Erase Protect, Activity, FPGA Loaded, and Recording. The of eight LEDs on the rear-right of the unit indicate the amount of non-volatile memory storage area used/available in the Phantom CineMag.

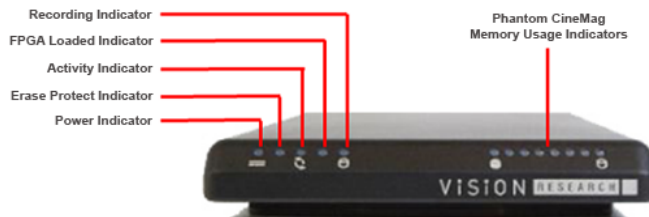

Phantom CineMag (rear view)

For details refer to [Phantom CineMag I & II Indicators](#)

4.4.6 Phantom CineMag I

The Phantom CineMag consist of two groups of indicators. A group of five indicators on the rear-left of the unit, from left to right, Power, Erase Protect, Activity, FPGA Loaded, and Recording. The of eight LEDs on the rear-right of the unit indicate the amount of non-volatile memory storage area used/available in the Phantom CineMag.

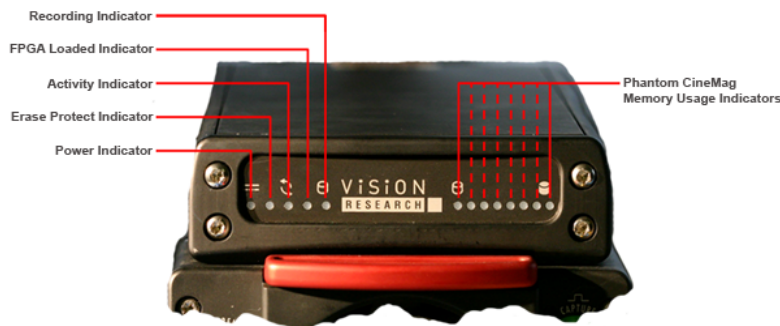

Phantom CineMag (rear view)

For details refer to [Phantom CineMag I & II Indicators](#)

4.4.7 Phantom CineStation IV

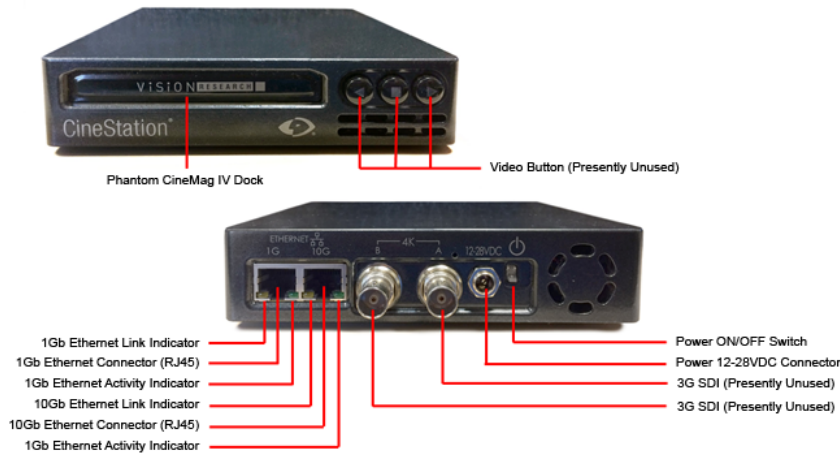

Click the link below for detail description:

- [Phantom 1Gb Ethernet Connector](#)
- [Phantom 10GB Ethernet Connector](#)
- Phantom CineStation IV Power Switch
- Phantom CineStation IV Power Connector
- [Phantom CineStation IV Indicators](#)

4.4.8 Phantom 10G CineStation

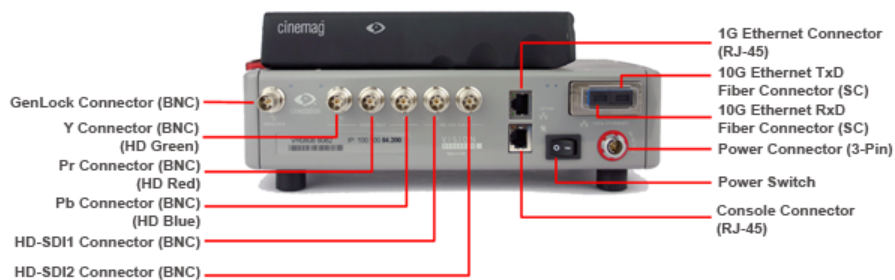

Click the link below for detail description:

- [Phantom CineStation 10G Fiber Optic Connector \(SC\)](#)
- [Phantom CineStation HD-SDI Connectors \(BNC\)](#)
- Phantom CineStation Power Switch (Self-explanatory)
- [Phantom Console Connector \(RJ-45\)](#)
- [Phantom GenLock Connector \(BNC\)](#)
- [Phantom RJ-45 Ethernet Connector](#)
- [Phantom Power Connector \(3-Pin Male\)](#)

4.4.9 Phantom 1G CineStation



Click the link below for detail description:

- [Phantom CineStation HD-SDI Connectors \(BNC\)](#)
- [Phantom CineStation Power Switch \(Self-explanatory\)](#)
- [Phantom Console Connector \(RJ-45\)](#)
- [Phantom Power Connector \(3-Pin Male\)](#)
- [Phantom RJ-45 Ethernet Connector](#)

4.4.10 Phantom Remote Control Unit



Click the link below for detail description:

- [Phantom RCU Battery Compartment](#)
- [Phantom RCU HD-SDI Video-In Connector \(BNC\)](#)

- [Phantom RCU HD-SDI Video-In Connector \(BNC\)](#)
- [Phantom RCU Optional Bluetooth](#)
- [Phantom RCU Power, Control, Analog Video Connector](#)
- [Phantom RCU Type A USB Receptacle](#)
- [Phantom RCU Control Buttons](#)
- [Phantom RCU Indicators](#)

4.5 Phantom On-Camera Control Buttons

4.5.1 Current Cameras

Vision Research categorizes Phantom cameras as Current for cameras that are presently being manufactured or sold. These products receive full support from Vision Research, including, all development and new features. Service contracts are available for these products.

4.5.1.1 Phantom Flex Series

The current Phantom Flex Series cameras include: Phantom Flex4K and Flex.

4.5.1.1.1 Phantom Flex4K / Flex4K-GS

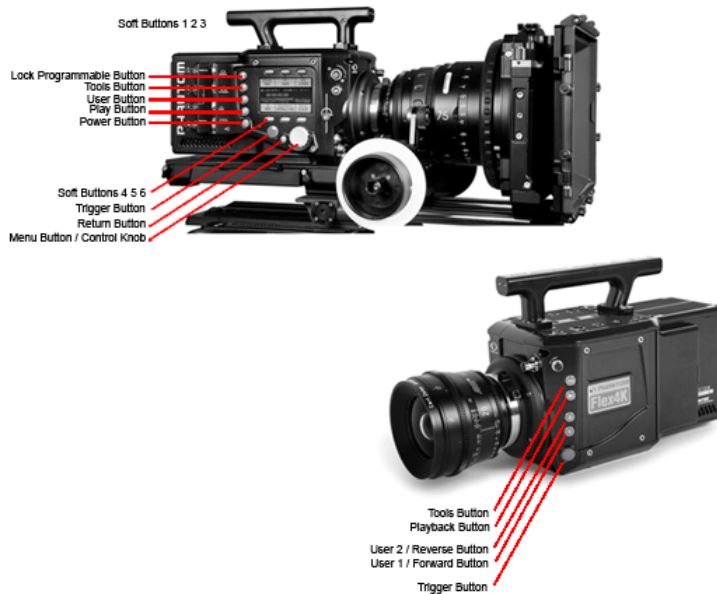

Left side button functions vary based on the camera's operational mode, as follows:

Lock Programmable

By default, long press locks all menus, besides trigger

Tools

Live Mode - Short press cycles through video tools: Zoom 1; Zoom 2; Threshold.

Live Mode - Long press initiates BREF (black reference).

Playback Mode – Tap for reverse playback. Hold in for fast-reverse

User 1

Live Mode - Not active

User 2

Live Mode - Not active

Playback Mode - Tap to set 'Mark Out' point. Long press re-sets 'Mark Out' point.



User 1 and User 2 combined: Long press to save from RAM to Mag

Play

Live Mode - Short press starts playback of last take (whether in RAM or CineMag IV). Live Mode - Long press will enter select mode, where user can toggle between various RAM and CineMag takes. Select RAM/Mag by pressing 'Tools' button, and User 1 / User 2 buttons to toggle through mag takes

Playback Mode - Plays forward. Hold in to fast-forward. Tap to Pause.

Power

Powers up camera when running on battery. Long press turns off camera.

Soft Buttons (1 2 3 4 5 6)

Functions change based on active menu.

Trigger

Live Mode - Short press to trigger camera when in recording (capture) mode.

Live Mode - Long press will erase the contents of RAM and start recording again.

Playback Mode - Tap trigger to return camera to 'live' mode.

Return

Returns to 'Previous' screen

Menu Button / Control Knob

Press to enter menu. Scroll through settings in all menus, and press to select

4.5.1.1.2 Phantom Flex



The Phantom Flex On-Camera Control buttons include:

B-REF Button

When the camera is in the LIVE PRE, LIVE WTr, or LIVE CST modes the B-REF button is used to initiate a Black Reference Calibration adjustment.

When the camera is in the playback, PLAY CST, mode the B-REF button will be used to play and/or stop the playback of the recorded/stored Cine files.

Tools Button

The Tools Button button is used to toggle through live preview, zoom, and threshold modes, when the camera is in the Preview, Waiting for Pre-Trigger (LIVE PRE) and Preview, Waiting for Trigger (LIVE WTR) or Capture modes.



The zoom mode provides a 1:1 pixel view.

When the camera is in the playback, PLAY CST, mode the Tools button is used to play and/or stop the playback of the recorded/stored Cine file in reverse.

Select/Live Button

The Select Button is used to select a recorded Cine to be reviewed, edit, and/or saved.

Settings Button

The Settings Button is used to access and select the camera's set up and recording parameters. The camera's parameters can be defined when the camera is in either the Pre-Trigger LIVE PRE (Preview, Waiting for Pre-Trigger), and Capture, LIVE WTR (Preview, Waiting for Trigger), modes.

It is also used to access the Edit and Save commands from the Play CST display screen.

The Setup Select button can also be used to scroll through a recorded Cine file to find images that you wish to define as Mark-In and Mark-Out points of the file easily.

Trigger Button

The Trigger button is used to change the camera's operational state when the camera is in either the; Pre-Trigger LIVE PRE (Preview, Waiting for Pre-Trigger), and Capture, LIVE WTR (Preview, Waiting for Trigger), modes. It can be used to place the camera into the Capture mode, and provide a soft-trigger to the camera when the camera is in the Capture, LIVE WTR (Preview, Waiting for Trigger) mode.

When running in Run/Stop Mode the camera will capture frames, (to the Phantom CineMag), after the trigger is pressed once, and stops capturing when the trigger is pressed again.

The Trigger Button is also used to exit the Camera Settings Display Screens.

4.5.1.2 Phantom UHS Series

Enter topic text here.

4.5.1.2.1 Phantom UHS v2640



OCC (ON CAMERA CONTROLS / TYPE)

- | | |
|--------------------------|-------------------------|
| ① B-REF / push-button | ④ MENU / rotary knob |
| ② TOOLS / push-button | ⑤ TRIGGER / push-button |
| ③ PLAYBACK / push-button | |

The Phantom UHS Series On-Camera Control buttons include:

B-REF

When the camera is in the Live Preview, Capture or Play Cine-Stored modes the B-REF button is used to initiate a Black Reference Calibration adjustment.

When the camera is in the playback, PLAY Cine-Stored, mode the B-REF button will be used to play the Cine forward.

Tools

The Tools Button button is used to toggle through live preview, zoom, and threshold modes, when the camera is in the Live Preview, and or Capture modes. It can also be used to play the Cine in reverse.

Playback

The Playback button is used to access the Playback, Playback Options display screens, and start the playback process

Menu

The Settings Button is used to access and select the camera's set up and recording parameters. The camera's parameters can be defined when the camera is in either the Live Preview, and Capture modes.

It is also used to select the Edit and Save commands from the Play Cine-Stored display screen.

The Menu button can also be used to scroll through a recorded Cine to find images that you wish to define as Mark-In and Mark-Out points of the file easily.

Trigger

The Trigger button is used to change the camera's operational state when the camera is in either the; Live Preview, or Capture, modes. It can be used to place the camera into the Capture mode, and provide a soft-trigger to the camera when the camera is in the Capture mode.

When running in Run/Stop Mode the camera will capture frames, (to the Phantom CineMag), after the trigger is pressed once, and stops capturing when the trigger is pressed again.

The Trigger Button is also used to exit the Camera Settings Display Screens.

4.5.1.2.2 Phantom UHS xx12 Series

The current Phantom UHS (Ultra-high Speed) Series cameras include: Phantom v2512, v2012, v1612, and v1212.

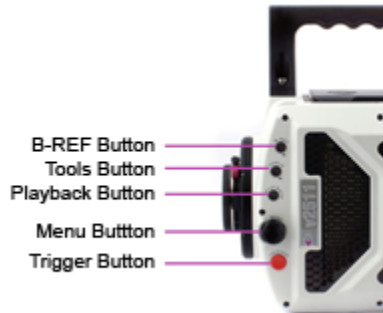

The Phantom UHS Series On-Camera Control buttons include:

B-REF

When the camera is in the Live Preview, Capture or Play Cine-Stored modes the B-REF button is used to initiate a Black Reference Calibration adjustment.

When the camera is in the playback, PLAY Cine-Stored, mode the B-REF button will be used to play the Cine forward.

Tools

The Tools Button button is used to toggle through live preview, zoom, and threshold modes, when the camera is in the Live Preview, and or Capture modes. It can also be used to play the Cine in reverse.

Playback

The Playback button is used to access the Playback, Playback Options display screens, and start the playback process

Menu

The Settings Button is used to access and select the camera's set up and recording parameters. The camera's parameters can be defined when the camera is in either the Live Preview, and Capture modes.

It is also used to select the Edit and Save commands from the Play Cine-Stored display screen.

The Menu button can also be used to scroll through a recorded Cine to find images that you wish to define as Mark-In and Mark-Out points of the file easily.

Trigger

The Trigger button is used to change the camera's operational state when the camera is in either the; Live Preview, or Capture, modes. It can be used to place the camera into the Capture mode, and provide a soft-trigger to the camera when the camera is in the Capture mode.

When running in Run/Stop Mode the camera will capture frames, (to the Phantom CineMag), after the trigger is pressed once, and stops capturing when the trigger is pressed again.

The Trigger Button is also used to exit the Camera Settings Display Screens.

4.5.1.2.3 Phantom UHS xx11 Series

The current Phantom UHS (Ultra-high Speed) Series cameras include: Phantom v2511, v2011, v1611, and v1211.

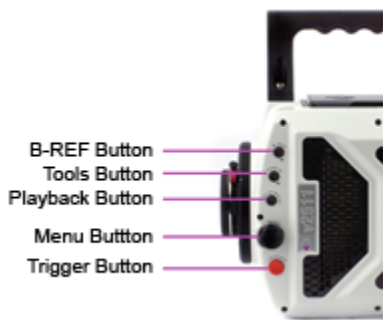

The Phantom UHS Series On-Camera Control buttons include:

B-REF

When the camera is in the Live Preview, Capture or Play Cine-Stored modes the B-REF button is used to initiate a Black Reference Calibration adjustment.

When the camera is in the playback, PLAY Cine-Stored, mode the B-REF button will be used to play the Cine forward.

Tools

The Tools Button button is used to toggle through live preview, zoom, and threshold modes, when the camera is in the Live Preview, and or Capture modes. It can also be used to play the Cine in reverse.

Playback

The Playback button is used to access the Playback, Playback Options display screens, and start the playback process

Menu

The Settings Button is used to access and select the camera's set up and recording parameters. The camera's parameters can be defined when the camera is in either the Live Preview, and Capture modes.

It is also used to select the Edit and Save commands from the Play Cine-Stored display screen.

The Menu button can also be used to scroll through a recorded Cine to find images that you wish to define as Mark-In and Mark-Out points of the file easily.

Trigger

The Trigger button is used to change the camera's operational state when the camera is in either the; Live Preview, or Capture, modes. It can be used to place the camera into the Capture mode, and provide a soft-trigger to the camera when the camera is in the Capture mode.

When running in Run/Stop Mode the camera will capture frames, (to the Phantom CineMag), after the trigger is pressed once, and stops capturing when the trigger is pressed again.

The Trigger Button is also used to exit the Camera Settings Display Screens.

4.5.1.3 Phantom v-Series

The current Phantom v-Series cameras include: Phantom v642 Broadcast, v711, v641, v611, v411, and v341.



The Phantom v642 On-Camera Control buttons include:

Playback Button

The Playback Button is used to select a recorded Cine to be reviewed, edit, and/or saved.

B-REF Button

When the camera is in the LIVE PRE, LIVE WTn, or LIVE CST modes the B-REF button is used to initiate a Black Reference Calibration adjustment.

When the camera is in the playback, PLAY CST, mode the B-REF button will be used to play and/or stop the playback of the recorded/stored Cine files.

Tools Button

The Tools Button button is used to toggle through live preview, zoom, and threshold modes, when the camera is in the Preview, Waiting for Pre-Trigger (LIVE PRE) and Preview, Waiting for Trigger (LIVE WTR) or Capture modes.



The zoom mode provides a 1:1 pixel view.

When the camera is in the playback, PLAY CST, mode the Tools button is used to play and/or stop the playback of the recorded/stored Cine file in reverse.

Trigger Button

The Trigger button is used to change the camera's operational state when the camera is in either the; Pre-Trigger LIVE PRE (Preview, Waiting for Pre-Trigger), and Capture, LIVE WTR (Preview, Waiting for Trigger), modes. It can be used to place the camera into the Capture mode, and provide a soft-trigger to the camera when the camera is in the Capture, LIVE WTR (Preview, Waiting for Trigger) mode.

When running in Run/Stop Mode the camera will capture frames, (to the Phantom CineMag), after the trigger is pressed once, and stops capturing when the trigger is pressed again.

The Trigger Button is also used to exit the Camera Settings Display Screens.

Menu Button

The Menu Button is used to access and select the camera's set up and recording parameters. The camera's parameters can be defined when the camera is in either the Pre-Trigger LIVE PRE (Preview, Waiting for Pre-Trigger), and Capture, LIVE WTR (Preview, Waiting for Trigger), modes.

It is also used to access the Edit and Save commands from the Play CST display screen.

The Setup Select button can also be used to scroll through a recorded Cine file to find images that you wish to define as Mark-In and Mark-Out points of the file easily.

4.5.1.4 Phantom Miro LAB Series

The current Phantom Miro LAB Series cameras include the Miro LAB110, LAB310, LAB3a10, LAB120, LAB320, LAB140, and LAB340.



AutoSet Button

Today, it simply performs a CSR by closing the internal mechanical shutter and issuing a command to the camera to do a current session reference. This functionality will likely be enhanced in the future.

Trigger Button

The Trigger Button when depressed provides a hard trigger to the camera.

Phantom CineFlash Compartment

The Phantom CineFlash Compartment houses the Phantom CineFlash module.

4.5.1.5 Phantom VEO S Series

The current Phantom VEO S Series cameras include: VEO 710S, VEO 410S, VEO 640S, VEO 340S, VEO 590S, VEO 990S. The VEO4K-PL Series utilizes the same controls as the VEO S Series cameras.

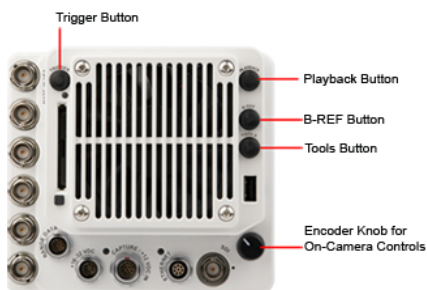

Trigger Button

Used to exit the 'Menu Screens' and return to 'Live' mode.

Live Mode - places the camera into 'Capture' when held for 4 seconds.

Capture Mode - provides a soft-trigger to the camera when the camera is in the Capture mode

Playback Button

Used to access the 'Playback Menu' only.

B-REF Button

Used to initiate a Black Reference when depressed for 4 seconds.

Playback Mode - Tap to playback forward. Hold in for fast-forward

Tools Button

Live Mode - Short press cycles through video tools: Zoom 1; Zoom 2; Threshold.

Playback Mode – Tap for reverse playback. Hold in for fast-reverse.

Menu Knob

Push to select menu option.

4.5.1.6 Phantom Miro M / R / LC Series

The current Phantom Miro M / R / LC Series cameras include: Miro M340, M320S, M310, M140, M120, M110, R320S, R310, R120, R110, LC320S, LC310, LC120, LC110.

**AutoSet Button**

Today, it simply performs a CSR by closing the internal mechanical shutter and issuing a command to the camera to do a current session reference. This functionality will likely be enhanced in the future.

Trigger Button

The Trigger Button when depressed provides a hard trigger to the camera.

Battery Release Switch

The Battery Release Switch is used to release an attached battery.

Battery Status Button

The Battery Status Button when depressed the Battery Status Indicators provide the amount of battery life remaining in the battery.

Phantom CineFlash Copartment

The Phantom CineFlash Copartment houses the Phantom CineFlash module.

4.5.1.7 Phantom Miro eX4

Power On/Trigger Button

The Power-On/Trigger button can be used to power on the camera, and once the camera is powered up and in the Live WTR mode this button will apply a hard-trigger to the camera.

4.5.2 Discontinued Cameras

Vision Research categorizes Phantom cameras as Discontinued for cameras that are no longer being manufactured or sold, except as refurbished products. These products will continue to receive full support from Vision Research for 5 years. However, all development has stopped and no new features will be added. Service contracts will continue to be available for terms that do not extend into the obsolescence of the products in 5 years.

4.5.2.1 Phantom 65

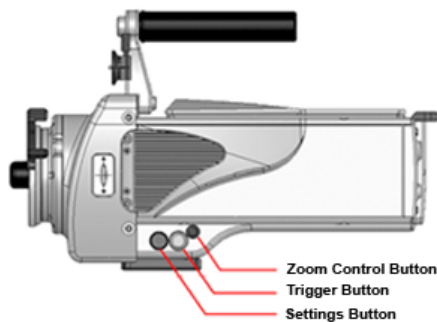

The Phantom 65 camera can be controlled via On-Camera Control buttons, including:

Zoom Button

This button is used to toggle through live preview, zoom, and threshold modes, when the camera is in the Preview, Waiting for Pre-Trigger (LIVE PRE) and Preview, Waiting for Trigger (LIVE WTR) or Capture modes.



The zoom mode provides a 1:1 pixel view.

When the camera is in the Cine recorded, stored in memory, (LIVE CST) state the Zoom button will be used to place the camera into the playback (PLAY CST) mode. When the camera is in the playback, PLAY CST, mode the Zoom button will be used to play and/or stop the playback of the recorded/stored Cine files.

Trigger Button

The Trigger button is used to change the camera's operational state when the camera is in either the; Pre-Trigger LIVE PRE (Preview, Waiting for Pre-Trigger), and Capture, LIVE WTR (Preview, Waiting for Trigger), modes. It is also used to provide a soft-trigger to the camera when the camera is in the Capture, LIVE WTR (Preview, Waiting for Trigger) mode.

When the camera is in the playback, PLAY CST, mode the Trigger button is used to play and/or stop the playback of the recorded/stored Cine file in reverse.

When running in Run/Stop Mode the camera will capture frames, (to the Phantom CineMag), after the trigger is pressed

once, and stops capturing when the trigger is pressed again.

Select Setup (Settings) Button

This button is used to select the camera's set up and recording parameters. The camera's parameters can be defined when the camera is in either the Pre-Trigger LIVE PRE (Preview, Waiting for Pre-Trigger), and Capture, LIVE WTR (Preview, Waiting for Trigger), modes.

It also allows you to scroll through the Cine file stored in the camera's RAM image buffer and the Phantom CineMag Flash memory for playback.

The Setup Select button can also be used to scroll through a recorded Cine file to find images that you wish to define as Mark-In and Mark-Out points of the file easily.

4.5.2.2 Phantom HD Series

The discontinued Phantom HD Series cameras include:

CAMERA MODEL	DISCONTINUED DATE	OBSOLETE DATE
Phantom HD Gold	31-Dec-2011	31-Dec-2016
Phantom HD	31-Dec-2011	31-Dec-2016

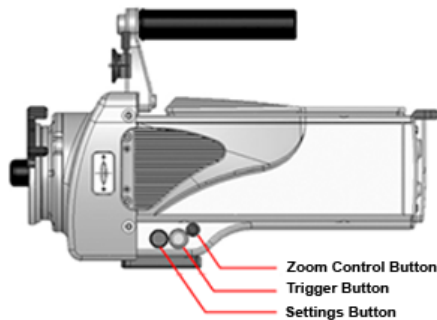

The Phantom HD Series cameras can be controlled via On-Camera Control buttons, including:

Zoom Button

This button is used to toggle through live preview, zoom, and threshold modes, when the camera is in the Preview, Waiting for Pre-Trigger (LIVE PRE) and Preview, Waiting for Trigger (LIVE WTR) or Capture modes.



The zoom mode provides a 1:1 pixel view.

When the camera is in the Cine recorded, stored in memory, (LIVE CST) state the Zoom button will be used to place the camera into the playback (PLAY CST) mode. When the camera is in the playback, PLAY CST, mode the Zoom button will be used to play and/or stop the playback of the recorded/stored Cine files.

Trigger Button

The Trigger button is used to change the camera's operational state when the camera is in either the; Pre-Trigger LIVE PRE (Preview, Waiting for Pre-Trigger), and Capture, LIVE WTR (Preview, Waiting for Trigger), modes. It is also used to provide a soft-trigger to the camera when the camera is in the Capture, LIVE WTR (Preview, Waiting for Trigger) mode.

When the camera is in the playback, PLAY CST, mode the Trigger button is used to play and/or stop the playback of the recorded/stored Cine file in reverse.

When running in Run/Stop Mode the camera will capture frames, (to the Phantom CineMag), after the trigger is pressed once, and stops capturing when the trigger is pressed again.

Select Setup (Settings) Button

This button is used to select the camera's set up and recording parameters. The camera's parameters can be defined when the camera is in either the Pre-Trigger LIVE PRE (Preview, Waiting for Pre-Trigger), and Capture, LIVE WTR (Preview, Waiting for Trigger), modes.

It also allows you to scroll through the Cine file stored in the camera's RAM image buffer and the Phantom CineMag Flash memory for playback.

The Setup Select button can also be used to scroll through a recorded Cine file to find images that you wish to define as Mark-In and Mark-Out points of the file easily.

4.5.2.3 Phantom UHS xx10 Series

The discontinued Phantom HD Series cameras include:

CAMERA MODEL	DISCONTINUED DATE	OBSOLETE DATE
Phantom v2010	31-Dec-2014	31-Dec-2019
Phantom v1610	31-Dec-2014	31-Dec-2019
Phantom v1210	31-Dec-2014	31-Dec-2019

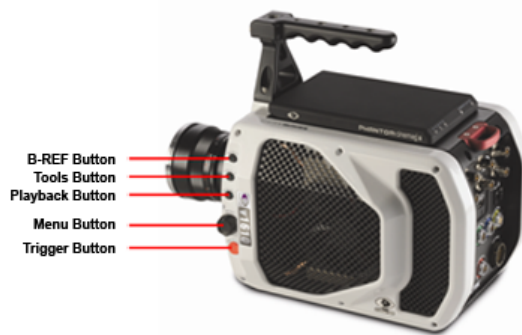

The Phantom UHS xx10 Series On-Camera Control buttons include:

B-REF

When the camera is in the Live Preview, Capture or Play Cine-Stored modes the B-REF button is used to initiate a Black Reference Calibration adjustment.

When the camera is in the playback, PLAY Cine-Stored, mode the B-REF button will be used to play the Cine forward.

Tools

The Tools Button button is used to toggle through live preview, zoom, and threshold modes, when the camera is in the Live Preview, and or Capture modes. It can also be used to play the Cine in reverse.

Playback

The Playback button is used to access the Playback, Playback Options display screens, and start the playback process

Menu

The Settings Button is used to access and select the camera's set up and recording parameters. The camera's parameters can be defined when the camera is in either the Live Preview, and Capture modes.

It is also used to select the Edit and Save commands from the Play Cine-Stored display screen.

The Menu button can also be used to scroll through a recorded Cine to find images that you wish to define as Mark-In and Mark-Out points of the file easily.

Trigger

The Trigger button is used to change the camera's operational state when the camera is in either the; Live Preview, or Capture, modes. It can be used to place the camera into the Capture mode, and provide a soft-trigger to the camera when the camera is in the Capture mode.

When running in Run/Stop Mode the camera will capture frames, (to the Phantom CineMag), after the trigger is pressed once, and stops capturing when the trigger is pressed again.

The Trigger Button is also used to exit the Camera Settings Display Screens.

4.5.2.4 Phantom Vx11 Series

The discontinued Phantom Vx11 Series cameras include:

CAMERA MODEL	DISCONTINUED DATE	OBSOLETE DATE
Phantom v311	14-Apr-2014	14-Apr-2019
Phantom v211	04-Apr-2014	04-Apr-2019



The Phantom v311 On-Camera Control buttons include:

Playback Button

The Playback Button is used to select a recorded Cine to be reviewed, edit, and/or saved.

B-REF Button

When the camera is in the LIVE PRE, LIVE WTR, or LIVE CST modes the B-REF button is used to initiate a Black Reference Calibration adjustment.

When the camera is in the playback, PLAY CST, mode the B-REF button will be used to play and/or stop the playback of the recorded/stored Cine files.

Tools Button

The Tools Button button is used to toggle through live preview, zoom, and threshold modes, when the camera is in the Preview, Waiting for Pre-Trigger (LIVE PRE) and Preview, Waiting for Trigger (LIVE WTR) or Capture modes.



The zoom mode provides a 1:1 pixel view.

When the camera is in the playback, PLAY CST, mode the Tools button is used to play and/or stop the playback of the recorded/stored Cine file in reverse.

Trigger Button

The Trigger button is used to change the camera's operational state when the camera is in either the; Pre-Trigger LIVE PRE (Preview, Waiting for Pre-Trigger), and Capture, LIVE WTR (Preview, Waiting for Trigger), modes. It can be used to place the camera into the Capture mode, and provide a soft-trigger to the camera when the camera is in the Capture, LIVE WTR (Preview, Waiting for Trigger) mode.

When running in Run/Stop Mode the camera will capture frames, (to the Phantom CineMag), after the trigger is pressed once, and stops capturing when the trigger is pressed again.

The Trigger Button is also used to exit the Camera Settings Display Screens.

Menu Button

The Menu Button is used to access and select the camera's set up and recording parameters. The camera's parameters can be defined when the camera is in either the Pre-Trigger LIVE PRE (Preview, Waiting for Pre-Trigger), and Capture, LIVE WTR (Preview, Waiting for Trigger), modes.

It is also used to access the Edit and Save commands from the Play CST display screen.

The Setup Select button can also be used to scroll through a recorded Cine file to find images that you wish to define as Mark-In and Mark-Out points of the file easily.

4.5.2.5 Phantom Miro eX Series

The discontinued Phantom Miro eX Series cameras include:

CAMERA MODEL	DISCONTINUED DATE	OBSOLETE DATE
Phantom Miro eX2	18-Feb-2015	17-Feb-2020
Phantom Miro eX3	14-Nov-2011	14-Nov-2016
Phantom Miro eX1	14-Nov-2011	14-Nov-2016

Power On/Trigger Button

The Power-On/Trigger button can be used to power on the camera, and once the camera is powered up and in the Live WTR mode this button will apply a hard-trigger to the camera.

4.5.3 Obsolete Cameras

Vision Research categorizes Phantom cameras as Obsolete for cameras that are no longer being manufactured or sold. These products no longer receive full support from Vision Research. All development has stopped and no new features will be added. No service contracts will be available.

4.5.3.1 Phantom Miro 4

Power On/Trigger Button

The Power-On/Trigger button can be used to power on the camera, and once the camera is powered up and in the Live WTR mode this button will apply a hard-trigger to the camera.

4.5.3.2 Phantom Miro 2

Power On/Trigger Button

The Power-On/Trigger button can be used to power on the camera, and once the camera is powered up and in the Live WTR mode this button will apply a hard-trigger to the camera.

4.5.3.3 Phantom Miro 1

Power On/Trigger Button

The Power-On/Trigger button can be used to power on the camera, and once the camera is powered up and in the Live WTR mode this button will apply a hard-trigger to the camera.

4.5.4 Peripherals

4.5.4.1 Phantom RCU (Remote Control Unit)

Hardware Components

Touchscreen Display: The 5" diagonal, 800 x 480, Active Touchscreen TFT, (Thin Film Transistor- Liquid Crystal Display), LCD allows the end-user to control a Phantom camera.

Jog/Scroll Dial: The Jog/Scroll Dial provides an alternate way to change many settings or scrub through a recorded Cine file.

Buttons

Trigger - Once the camera is powered up and in the Live PRE mode, pressing the Trigger button will put the camera into Live WTR mode and begin recording the first Cine. While in Live WTR mode, the Trigger button will apply a trigger signal to the camera. When the camera is configured to directly record into the attached Phantom CineMag in "Run / Stop" mode, the Trigger button is re-purposed as a "Run / Stop" button. Pressing the Trigger button will start and stop the recording at any time.

Menu - The Menu button is used to:

- Power On the Remote Control Unit
- Provide a quick return to the Home Menu
- Power Off the Remote Control Unit
- Return to last menu when menus have been dismissed from the screen

Video - This button is used to toggle through the following display modes:

1. Live Preview - Places the camera into its default preview mode provides a live image.
2. Zoom -Zoom mode instructs the camera to zoom in on the subject area with a 1:1 pixel view to help in the focusing process when the camera is attached to a monitor or viewfinder. Zoom and Unzoom may appear to look the same depending on the camera resolution settings.
3. Threshold - The Threshold mode is used to display the areas of the image that are overexposed. The Remote Control Unit will reduce the saturation of any pixel that below 90% saturated by 50%, and double the saturation level of any pixel that is saturated by more than 90% to exaggerate the over-exposed area of an image.

In addition the Video button can also be used to control the scaling of the video image from 1:1 to 1:7. To do so, hold the Video button and simultaneously rotate the inner Jog wheel forwards to increase the size of the video, or backwards to decrease it.

A - Press the A button to activate the user-defined Program assigned to the button.

Mark In (Only active when Play Display Screen is active.)

B - Press the B button to activate the user-defined Program assigned to the button.

Mark Out (Only active when Play Display Screen is active.)

4.6 Connector Descriptions



The connector references in this module are not intended, nor should they be used, as a cable schematic to build connection cables. Building your own cables can cause serious damage to the camera. Only connector cables provided by Vision Research should be used.

The connector reference are from the perspective of viewing the front of the connectors, not their interal (from behind) view.

4.6.1 Phantom 10/100 Ethernet Connector (6-Pin Female)

This connector provides a means to connect the controlling laptop or PC to a Phantom Miro-Series camera. The Ethernet connector provides connectivity to other cameras in a multi-camera setup.

CONNECTOR	PIN	NOMENCLATURE	FUNCTIONAL DESCRIPTION
	1	UNUSED	Not Used
	2	UNUSED	Not Used
	3	UNUSED	Not Used
	4	UNUSED	Not Used
	5	ETHRX+	10/100BASE-T Ethernet Receive Data (positive)
	6	ETHRX-	10/100BASE-T Ethernet Receive Data (negative)
	7	ETHTX+	10/100BASE-T Ethernet Transmit Data (positive)
	8	ETHTX-	10/100BASE-T Ethernet Transmit Data (negative)

4.6.2 Phantom 10G Connector (RJ-45)

This connector provides a 10G Ethernet connection to connect the controlling laptop or PC/laptop.

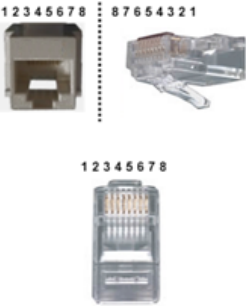
CONNECTOR	PIN	NOMENCLATURE	FUNCTIONAL DESCRIPTION
	1	XMDI0+	Medium Dependent Interface 0 (positive)
	2	XMDI0-	Medium Dependent Interface 0 (negative)
	3	XMDI1+	Medium Dependent Interface 1 (positive)
	4	XMDI2+	Medium Dependent Interface 2 (positive)
	5	XMDI2-	Medium Dependent Interface 2 (negative)
	6	XMDI1-	Medium Dependent Interface 1 (negative)
	7	XMDI3+	Medium Dependent Interface 3 (positive)
	8	XMDI3-	Medium Dependent Interface 3 (negative)

4.6.3 Phantom +12VDC (Aux)

CONNECTOR	PIN	NOMENCLATURE	FUNCTIONAL DESCRIPTION
	1	PGND	Power Ground
	2	+12VDC	The +12VDC is fused up to 1.5A.



4.6.4 Phantom Auxiliary Connector (4-Pin Female)

CONNECTOR	PIN	NOMENCLATURE	FUNCTIONAL DESCRIPTION
	1	PGND	Power Ground
	2	ISOGND	Common Ground
	3	Trigger-In	Isolated input. Active low. It can be activated by a switch to ground. On early cameras the trigger was level-sensitive, and was accepted if asserted (low) at the end of an exposure. As such, the trigger signal should have lasted at least as much as the reciprocal of the frame rate to guarantee it was recognized. Now the trigger is edge-sensitive, and the exact time of the trigger edge is recorded. The trigger pulse needs to be at least 3µs long.
	4	+12VDC	The +12VDC is fused up to 1.5A.

4.6.5 Phantom Breakout Box Connectors

These connectors provide all the inputs such as a trigger, unmodulated IRIG-B, frame sync, and event marker. In addition,

it also provides outputs such as strobe, f-sync, IRIG-B, and NTSC/PAL video.

CONNECTOR	PIN	NOMENCLATURE	FUNCTIONAL DESCRIPTION
 <p>Battery</p>	1	GND/+BATY	Ground/+24VDC Battery The 24VDC battery can be connected of either polarity between Pins 1 and 2.
	2	+BATY/GND	+24VDC Battery/Ground The 24VDC battery can be connected of either polarity between Pins 1 and 2.
	3	CHGND	Chassis Ground
 <p>Remote Control Connection</p>	1	+24V	Positive VDC
	2	-24V	Return
	3	VGND	Composite Video Ground/Shield
	4	Video	Video Out (Composite) The video output of the Phantom cameras is a standard level, 75-ohm output. It is not isolated. The video output should only drive a properly terminated (75-ohm) input. Also, for anything but the shortest cable runs, quality 75-ohm coax (e.g. RG59/U) must be used.
	5	TXDRC	RS-232
	6	RXDRC	RS-232
	7	GND	RS-232 Ground
	8	Unused	Not Used
	9	Unused	Not Used
 <p>20-36VDC 5A MAX Power</p>	1	Unused	Not Used
	2	CHGND	Chassis Ground
	3	-24V	Return
	4	+24V	Positive VDC
	1	NTSC / PAL	The NTSC/PAL output is a standard level, 75-ohm output. It is not isolated. The video output should only drive a properly terminated (75-ohm) input. Also, for

 <ol style="list-style-type: none"> 1. NTSC / PAL 2. GenLock 3. Event 4. Pretrigger 5. Trigger 6. F-Sync / A- Sync 7. Strobe 8. Ready 9. IRIG-Out 10. IRIG-In 			anything but the shortest cable runs, quality 75-ohm coax (e.g. RG59/U) must be used.
	2	GenLock	Used to synchronize the video playback to a signal, utilizing a composite video inbound signal. This video input signal should be a properly terminated, (75-ohm), and the signal must not exceed +1.56V maximum. For anything but the shortest cable runs, quality 75-ohm coax, (e.g. RG59/U), must be used. It will also synch live video, by synchronizing the SDI outputs to the GenLock signal, which is available on Phantom v.12.1 and later v-series camera models.
	3	Event	Event is an active-low isolated input whose state is recorded at the end of each exposure. The signal must be active when the strobe goes high, and be at least 30µs long to guarantee it is properly recorded.
	4	Pretrigger	This function allows the user to place the camera into the Ready State or Capture Mode when the falling edge of a 5V TTL pulse is detected.
	5	Trigger	Isolated input. Active low. It can be activated by a switch to ground. On early cameras the trigger was level-sensitive, and was accepted if asserted (low) at the end of an exposure. As such, the trigger signal should have lasted at least as much as the reciprocal of the frame rate to guarantee it was recognized. Now the trigger is edge-sensitive, and the exact time of the trigger edge is recorded. The trigger pulse needs to be at least 3µs long.
	6	F-Sync / A-Sync	The F-SYNC signal threshold is +5V maximum, so the input is also compatible with TTL levels and must be a properly terminated, (50-ohms). Frame Sync is a bi-directional isolated signal. When the Image-Based Auto-Trigger is installed in a camera, this port is an output, (A-SYNC), which indicates with a TTL signal when the camera has been triggered by the Image-Based Auto-Trigger. NOTE On a new series' camera with a dedicated F-SYNC BNC connection, this port does not function as an F-SYNC output.
	7	Strobe	Isolated open collector output, with 1k pull-up. When asserted (low) Strobe indicates that the camera integrates (the shutter is open). Strobe is low for the duration of the exposure.

	8	Ready	Isolated open collector output, with 1k pull-up. When high, indicates that the camera is in capture mode. In a multiple camera system, the READY outputs of up to 4 cameras can be connected together; the resulting signal will be high when all the cameras in the system are in capture mode.
	9	IRIG-Out	Phantom cameras provide unmodulated IRIG B time code inputs and outputs. The input withstands signals of up to +/- 15v. The input threshold is 1.5V, so the input is also compatible with TTL levels. The output swings to RS-232 levels of +/-9V.
	10	IRIG-In	Phantom cameras provide unmodulated IRIG B time code inputs and outputs. The input withstands signals of up to +/- 15v. The input threshold is 1.5V, so the input is also compatible with TTL levels. The output swings to RS-232 levels of +/-9V.

Optional Bluetooth[®] Antenna

The Optional Industrial Bluetooth provides wireless control of a user specified camera.

4.6.6 Phantom Capture Connector (8-Pin Male)

This connector provides all I/O connectivity such as Trigger, Ready, Frame Sync, IRIG-In, IRIG-Out, and Strobe to the Phantom camera.

CONNECTOR	PIN	NOMENCLATURE	FUNCTIONAL DESCRIPTION
	1	ISOGND	Ground/Shield
	2	IRIG-In	Phantom 65 and Phantom HD cameras provide unmodulated IRIG B time code input. The input withstands signals of up to +/- 15v. The input threshold is 1.5V, so the input is also compatible with TTL levels. All IRIG i/os are not isolated.
	3	PGND	The power input and the acquisition control signals are isolated from the camera system ground. This isolation is designed to avoid system ground loops only, and should not be subject to high voltages.
	4	IRIG-Out	Phantom 65 and Phantom HD cameras provide unmodulated IRIG B time code output. The output swings to RS-232 levels of +/-9V. All IRIG i/os are not isolated.
	5	FSYNC	Frame Sync is a bi-directional isolated signal.
	6	Ready-Out	Isolated open collector output, with 1k pull-up. When high, indicates that the camera is in capture mode. In a multiple camera system, the READY outputs of up

			to 4 cameras can be connected together; the resulting signal will be high when all the cameras in the system are in capture mode.
	7	Strobe-Out	Isolated open collector output, with 1k pull-up. When asserted (low) Strobe indicates that the camera integrates (the shutter is open). Strobe is low for the duration of the exposure.
	8	Trigger-In	Isolated input. Active low. It can be activated by a switch to ground. On early cameras the trigger was level-sensitive, and was accepted if asserted (low) at the end of an exposure. As such, the trigger signal should have lasted at least as much as the reciprocal of the frame rate to guarantee it was recognized. Now the trigger is edge-sensitive, and the exact time of the trigger edge is recorded. The trigger pulse needs to be at least 3 μ s long.

4.6.7 Phantom Capture Connector (Revision 4) (19-Pin Male)

This connector provides all the inputs such as 24VDC power, trigger, unmodulated IRIG-B, frame sync, (except on v12.1), and event marker. In addition, it also provides outputs such as strobe sync, IRIG-B, and NTSC/PAL video. RS232 control is also provided through this connector.

All acquisition control signals are isolated from the camera ground. They are referred to the signal 0VISO, which is connected to the shells of all BNCs in the breakout cables or breakout box.

The outputs are an open collector, each having a 1kohm pull-up to an isolated 5V supply. The maximum sink current of the outputs is 20mA. The inputs go to opto-coupler LEDs in series with 470 ohms to +5V. To assert a signal, it needs to be pulled down below 2V.

CONNECTOR	PIN	NOMENCLATURE	FUNCTIONAL DESCRIPTION
	A	Event-In	Event is an active-low isolated input whose state is recorded at the end of each exposure. The signal must be active when the strobe goes high, and be at least 30 μ s long to guarantee it is properly recorded.
	B	Trigger-In	Isolated input. Active low. It can be activated by a switch to ground. On early cameras the trigger was level-sensitive, and was accepted if asserted (low) at the end of an exposure. As such, the trigger signal should have lasted at least as much as the reciprocal of the frame rate to guarantee it was recognized. Now the trigger is edge-sensitive, and the exact time of the trigger edge is recorded. The trigger pulse needs to be at least 3 μ s long.
	C	Strobe Out	Isolated open collector output, with 1k pull-up. When asserted (low) Strobe indicates that the camera integrates (the shutter is open). Strobe is low for the

		duration of the exposure.
D	IRIG- In (Unmodulated)	Phantom v710, v640, v310, v210, and v12.1 Cameras provide unmodulated IRIG B time code inputs and outputs. The input withstands signals of up to +/- 15v. The input threshold is 1.5V, so the input is also compatible with TTL levels. The output swings to RS-232 levels of +/-9V.
E	IRIG Ground	Phantom v710, v640, v310, v210, and v12.1 Cameras provide unmodulated IRIG B time code inputs and outputs. The input withstands signals of up to +/- 15v. The input threshold is 1.5V, so the input is also compatible with TTL levels. The output swings to RS-232 levels of +/-9V.
F	Video Out (Composite)	The video output of the Phantom cameras is a standard level, 75-ohm output. It is not isolated. The video output should only drive a properly terminated (75-ohm) input. Also, for anything but the shortest cable runs, quality 75-ohm coax (e.g. RG59/U) must be used.
G	Video Ground (Composite)	Ground/Shield (For Video Out Signals and GenLock)
H	Serial (RS-232) Ground	All the serial ports are not isolated (referred to system ground). As such, they should only be connected to properly earthed equipment.
J	Chassis Ground	Ground
K	Transmit Data (RS-232)	Phantom v710, v640, v310, v210, and v12.1 cameras use true RS232 levels.
L	+12-30VDC	DC output of the camera, 0.5A amp Max. Typically used to power break out boxes..
M	Power Ground	The power input and the acquisition control signals are isolated from the camera system ground. This isolation is designed to avoid system ground loops only, and should not be subject to high voltages.
N	Auto-Trigger Output	<p>The image changes are analyzed, and when an auto-trigger condition has been detected, the auto-trigger signal will be pulled low. However, the camera will not trigger itself. An external device pulling the auto-trigger signal low will not trigger the camera either.</p> <p>This feature is useful when external control of the auto-trigger is desired, for instance, it is required that the auto-trigger feature is disabled for some known transient event. The auto-trigger signal from the camera will be routed through some external device and back into the trigger input of the camera.</p>

P	ISO Ground	Ground/Shield (For signals: A, B, C, R, and V)
R	Pre-Trigger In/ MemGate In	<p>Pre-Trigger</p> <p>This function allows the user to place the camera into the Ready State or Capture Mode when the falling edge of a 5V TTL pulse is detected.</p> <p>Memory Gate</p> <p>Active-low isolated input. When asserted, the current frame is discarded instead of being written into the memory. The decision is taken at the end of the exposure (after STROBE goes high). MemGate needs to be low the moment STROBE goes high and stays low for at least 15μs to disable recording of the current frame.</p>
S	IRIG Out (Unmodulated)	Phantom v710, v640, v310, v210, and v12.1 cameras provide unmodulated IRIG B time code inputs and outputs. The input withstands signals of up to +/- 15v. The input threshold is 1.5V, so the input is also compatible with TTL levels. The output swings to RS-232 levels of +/-9V.
T	GenLock	<p>Used to synchronize the playback to a video signal, utilizing a composite video inbound signal. This video input signal should be a properly terminated, (75-ohm), and the signal must not exceed +1.56V maximum. For anything but the shortest cable runs, quality 75-ohm coax, (e.g. RG59/U), must be used.</p> <p>It will also synch live video, by synchronizing the SDI outputs to the GenLock signal.</p>
U	Receive Data (RS-232)	Phantom v710, v640, v310, v210, and v12.1 Cameras use true RS232 levels.
V	Ready	Isolated open collector output, with 1k pull-up. When high, indicates that the camera is in capture mode. In a multiple camera system, the READY outputs of up to 4 cameras can be connected together; the resulting signal will be high when all the cameras in the system are in capture mode.

4.6.8 Phantom Capture Connector (Revision 3) (19-Pin Female)

This connector provides all the inputs such as 24VDC power, trigger, unmodulated IRIG-B, frame sync, and event marker. In addition, it also provides outputs such as strobe sync, IRIG-B, and NTSC/PAL video. RS232 control is also provided through this connector.

All acquisition control signals are isolated from the camera ground. They are referred to the signal 0VISO, which is connected to the shells of all BNCs in the breakout cables or breakout box.

The outputs are an open collector, each having a 1kohm pull-up to an isolated 5V supply. The maximum sink current of the

outputs is 20mA. The inputs go to opto-coupler LEDs in series with 470 ohms to +5V. To assert a signal, it needs to be pulled down below 2V.

CONNECTOR	PIN	NOMENCLATURE	FUNCTIONAL DESCRIPTION
	A	Event-In	Event is an active-low isolated input whose state is recorded at the end of each exposure. The signal must be active when the strobe goes high, and be at least 30μs long to guarantee it is properly recorded.
	B	Trigger-In	<p>Isolated input. Active low. It can be activated by a switch to ground. On early cameras the trigger was level-sensitive, and was accepted if asserted (low) at the end of an exposure. As such, the trigger signal should have lasted at least as much as the reciprocal of the frame rate to guarantee it was recognized.</p> <p>Now the trigger is edge-sensitive, and the exact time of the trigger edge is recorded. The trigger pulse needs to be at least 3μs long.</p>
	C	Strobe Out	Isolated open collector output, with 1k pull-up. When asserted (low) Strobe indicates that the camera integrates (the shutter is open). Strobe is low for the duration of the exposure.
	D	IRIG- In (Unmodulated)	Phantom v710, v640, v310, v210, and v12.1 Cameras provide unmodulated IRIG B time code inputs and outputs. The input withstands signals of up to +/- 15v. The input threshold is 1.5V, so the input is also compatible with TTL levels. The output swings to RS-232 levels of +/-9V.
	E	IRIG Ground	Phantom v710, v640, v310, v210, and v12.1 Cameras provide unmodulated IRIG B time code inputs and outputs. The input withstands signals of up to +/- 15v. The input threshold is 1.5V, so the input is also compatible with TTL levels. The output swings to RS-232 levels of +/-9V.
	F	Video Out (Composite)	The video output of the Phantom cameras is a standard level, 75-ohm output. It is not isolated. The video output should only drive a properly terminated (75-ohm) input. Also, for anything but the shortest cable runs, quality 75-ohm coax (e.g. RG59/U) must be used.
	G	Video Ground (Composite)	Ground/Shield (For Video Out Signals and GenLock)
	H	Serial (RS-232) Ground	All the serial ports are not isolated (referred to system ground). As such, they should only be connected to properly earthed equipment.
	J	Chassis Ground	Ground

	K	Transmit Data (RS-232)	Phantom v710, v640, v310, v210, and v12.1 cameras use true RS232 levels.
	L	+24VDC	<p>Phantom cameras use DC (Direct Current) power. The nominal power supply voltage is 24VDC. The acceptable power supply range is 20-36VDC. Power supply inputs are protected against polarity reversal (with a series-pass diode). The cameras are also protected to under voltage and will shut down when the DC input is below circa 17VDC.</p> <p>The power supply input terminals are isolated from the case and system ground. This is usually achieved by using a properly isolated power supply.</p> <p>NOTE</p> <p>Connecting the Phantom cameras to anything but a SELV (Safe Extra-Low Voltage) circuit will create an electrical shock hazard.</p> <p>The power supply Power (Watt) Rating should be rated 50% higher than ratings specified (for all camera models).</p>
	M	Power Ground	The power input and the acquisition control signals are isolated from the camera system ground. This isolation is designed to avoid system ground loops only, and should not be subject to high voltages.
	N	Auto-Trigger Output	<p>The image changes are analyzed, and when an auto-trigger condition has been detected, the auto-trigger signal will be pulled low. However, the camera will not trigger itself. An external device pulling the auto-trigger signal low will not trigger the camera either.</p> <p>This feature is useful when external control of the auto-trigger is desired, for instance, it is required that the auto-trigger feature is disabled for some known transient event. The auto-trigger signal from the camera will be routed through some external device and back into the trigger input of the camera.</p>
	P	ISO Ground	Ground/Shield (For signals: A, B, C, R, and V)
	R	Pre-Trigger In/ MemGate In	<p>Pre-Trigger</p> <p>This function allows the user to place the camera into the Ready State or Capture Mode when the falling edge of a 5V TTL pulse is detected.</p> <p>Memory Gate</p> <p>Active-low isolated input. When asserted, the current frame is discarded instead of being written into the memory. The decision is taken at the end of the exposure (after STROBE goes high). MemGate</p>

			needs to be low the moment STROBE goes high and stays low for at least 15 μ s to disable recording of the current frame.
	S	IRIG Out (Unmodulated)	Phantom v710, v640, v310, v210, and v12.1 cameras provide unmodulated IRIG B time code inputs and outputs. The input withstands signals of up to +/- 15v. The input threshold is 1.5V, so the input is also compatible with TTL levels. The output swings to RS-232 levels of +/-9V.
	T	GenLock	Used to synchronize the playback to a video signal, utilizing a composite video inbound signal. This video input signal should be a properly terminated, (75-ohm), and the signal must not exceed +1.56V maximum. For anything but the shortest cable runs, quality 75-ohm coax, (e.g. RG59/U), must be used. It will also synch live video, by synchronizing the SDI outputs to the GenLock signal.
	U	Receive Data (RS-232)	Phantom v710, v640, v310, v210, and v12.1 Cameras use true RS232 levels.
	V	Ready	Isolated open collector output, with 1k pull-up. When high, indicates that the camera is in capture mode. In a multiple camera system, the READY outputs of up to 4 cameras can be connected together; the resulting signal will be high when all the cameras in the system are in capture mode.



4.6.9 Phantom Capture Connector (Revision 2) (19-Pin Male)

This connector provides all the inputs such as the 24VDC power, trigger, unmodulated IRIG-B, frame sync, and event marker. In addition, it also provides outputs such as strobe sync, IRIG-B, RS170 video and frame sync. RS232 control is also provided in this connector.

All acquisition control signals are isolated from the camera ground. They are referred to the signal 0VISO, which is connected to the shells of all BNCs in the breakout cables.

The outputs are an open collector, each having a 1kohm pull-up to an isolated 5V supply. The maximum sink current of the outputs is 20mA. The inputs go to opto-coupler LEDs in series with 470 ohms to +5V. To assert a signal, it needs to be pulled down below 2V.

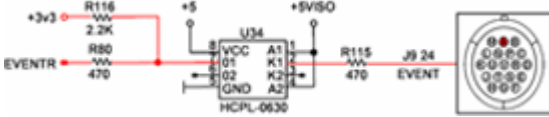
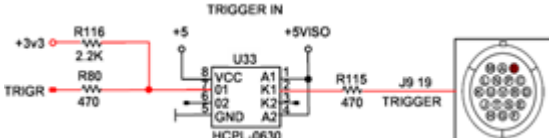
CONNECTOR	PIN	NOMENCLATURE	FUNCTIONAL DESCRIPTION
	A	Event In	Event is an active-low isolated input whose state is recorded at the end of each exposure. The signal must be active when the strobe goes high, and be at least 30 μ s long to guarantee it is properly recorded.

			
	B	Trigger In	<p>Isolated input. Active low. It can be activated by a switch to ground. On early cameras the trigger was level-sensitive, and was accepted if asserted (low) at the end of an exposure. As such, the trigger signal should have lasted at least as much as the reciprocal of the frame rate to guarantee it was recognized.</p> <p>Now the trigger is edge-sensitive, and the exact time of the trigger edge is recorded. The trigger pulse needs to be at least 3µs long.</p> 
	C	Strobe Out	<p>Isolated open collector output, with 1k pull-up. When asserted (low) Strobe indicates that the camera integrates (the shutter is open). Strobe is low for the duration of the exposure.</p> 
	D	IRIG- In (Unmodulated)	<p>Phantom v5.2, v7.3, v9.1, v10, and v12.0 Cameras provide unmodulated IRIG B time code inputs and outputs. The input withstands signals of up to +/- 15v. The input threshold is 1.5V, so the input is also compatible with TTL levels. The output swings to RS-232 levels of +/-9V. All IRIG i/os are not isolated.</p>
	E	IRIG Ground	Ground
	F	Video Out (Composite)	<p>The video output of the Phantom cameras is a standard level, 75-ohm output. It is not isolated. The video output should only drive a properly terminated (75 ohm) input. Also, for anything but the shortest cable runs, quality 75-ohm coax (e.g. RG59/U) must be used.</p>
	G	Video Ground (Composite)	Ground
	H	Serial (RS-232) GND (RS-422 GND)	<p>All the serial ports are not isolated (referred to system ground). As such, they should only be connected to properly earthed equipment.</p>
	J	Chassis Ground	Ground

	K	Transmit Data (RS-232)	Phantom v5.2, v7.3, v9.1, v10, and v12.0 Cameras use true RS232 levels.
	L	+24VDC	<p>Phantom cameras use DC (Direct Current) power. The nominal power supply voltage is 24VDC. The acceptable power supply range is 18-36VDC. Power supply inputs are protected against polarity reversal (with a series-pass diode). The cameras are also protected to under voltage and will shut down when the DC input is below circa 17VDC.</p> <p>The power supply input terminals are isolated from the case and system ground. This is usually achieved by using a properly isolated power supply.</p> <p>NOTE</p> <p>Connecting the Phantom cameras to anything but a SELV (Safe Extra-Low Voltage) circuit will create an electrical shock hazard.</p> <p>The power supply Power (Watt) Rating should be rated 50% higher than ratings specified (for all camera models).</p>
	M	Power Ground	The power input and the acquisition control signals are isolated from the camera system ground. This isolation is designed to avoid system ground loops only, and should not be subject to high voltages.
	N	Sync Imaging Frame Sync In/ Frame Sync Out	<p>Bi-directional isolated signal.</p>
	P	ISO Ground	Ground
	R	Pre-Trigger In/ MemGate In	<p>Pin R of the 19-pin capture connector is shared between the following two functions:</p> <p>MemGate</p> <p>Active-low isolated input. When asserted, the current frame is discarded instead of being written into the memory. The decision is taken at the end of the exposure (after STROBE goes high).</p> <p>MemGate needs to be low the moment STROBE goes</p>

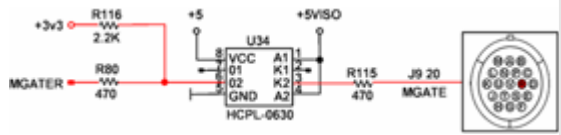
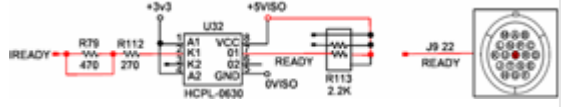

		<p>high and stays low for at least 15μs to disable recording of the current frame.</p>  <p>Pre-Trigger</p> <p>This function allows the user to place the camera into the Ready State or Capture Mode when the falling edge of a 5V TTL pulse is detected via Pin R.</p> <p>Selection of which function as Pin-R should utilize is defined via the Live>Advanced Settings>Pretrigger Pin Is setting.</p>
S	IRIG Out (Unmodulated)	Phantom v5.2, v7.3, v9.1, v10, and v12.0 Cameras provide unmodulated IRIG B time code inputs and outputs. The input withstands signals of up to +/- 15v. The input threshold is 1.5V, so the input is also compatible with TTL levels. The output swings to RS-232 levels of +/-9V. All IRIG i/os are not isolated.
T	UNUSED	Not used.
U	Receive Data (RS-232)	Phantom v5.2, v7.3, v9.1, v10, and v12.0 cameras use true RS232 levels.
V	Ready	<p>Isolated open collector output, with 1k pull-up. When high, indicates that the camera is in capture mode. In a multiple camera system, the READY outputs of up to 4 cameras can be connected together; the resulting signal will be high when all the cameras in the system are in capture mode.</p> 

4.6.10 Phantom Capture Connector (Revision 1) (19-Pin Male)

This connector provides all the inputs such as the 24VDC power, trigger, unmodulated IRIG-B, frame sync, and event marker. In addition, it also provides outputs such as strobe sync, IRIG-B, RS170 video and frame sync. RS232 control is also provided in this connector.

All acquisition control signals are isolated from the camera ground. They are referred to the signal 0VISO, which is connected to the shells of all BNCs in the breakout cables.

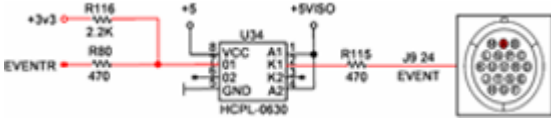
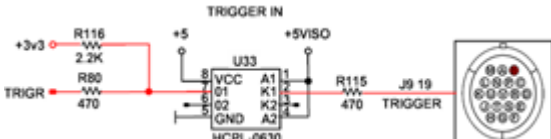
The outputs are an open collector, each having a 1kohm pull-up to an isolated 5V supply. The maximum sink current of the outputs is 20mA. The inputs go to opto-coupler LEDs in series with 470 ohms to +5V. To assert a signal, it needs to be pulled down below 2V.

CONNECTOR	PIN	NOMENCLATURE	FUNCTIONAL DESCRIPTION
	A	Event In	<p>Event is an active-low isolated input whose state is recorded at the end of each exposure. The signal must be active when strobe goes high, and be at least 30μs long to guarantee it is properly recorded.</p> 
	B	Trigger In	<p>Isolated input. Active low. It can be activated by a switch to ground. On early cameras the trigger was level-sensitive, and was accepted if asserted (low) at the end of an exposure. As such, the trigger signal should have lasted at least as much as the reciprocal of the frame rate to guarantee it was recognized.</p> <p>Now the trigger is edge-sensitive, and the exact time of the trigger edge is recorded. The trigger pulse needs to be at least 3μs long.</p> 
	C	Strobe Out	<p>Isolated open collector output, with 1k pull-up. When asserted (low) Strobe indicates that the camera integrates (the shutter is open). Strobe is low for the duration of the exposure.</p> 
	D	IRIG- In (Unmodulated)	<p>Phantom v4.2, v4.3, v5.0, v5.1, v6.0, v6.2, v7.0, v7.1, v7.2, and v9.0 Cameras provide unmodulated IRIG B time code inputs and outputs. The input withstands signals of up to +/- 15v. The input threshold is 1.5V, so the input is also compatible with TTL levels. The output swings to RS-232 levels of +/-9V. All IRIG i/os are not isolated.</p> <p>Phantom v4.1 Cameras provide unmodulated IRIG B time code inputs and outputs. The input withstands signals of up to +/- 15v. The input threshold is 1.5V, so the input is also compatible with TTL levels. The output swings between 0 and 5V. All IRIG i/os are not isolated.</p>
	E	IRIG Ground	
	F	Video Out	The video output of the Phantom cameras is a standard

	(Composite)	level, 75-ohm output. It is not isolated. The video output should only drive a properly terminated (75-ohm) input. Also, for anything but the shortest cable runs, quality 75-ohm coax (e.g. RG59/U) must be used.
G	Video Ground (Composite)	
H	RS-232 GND (RS-422 GND)	All the serial ports are not isolated (referred to system ground). As such, they should only be connected to properly earthed equipment.
J	Reserved (RS-422 TXD +)	<p>Phantom v4.2, v4.3, v5.1, v6.2, v7.1, v7.2, and v9.0 Cameras use true RS232 levels.</p> <p>Phantom v5.0, v6.0, and v7.0 cameras provide two asynchronous interface ports. The primary port uses true RS232 levels.</p> <p>The secondary port (only enabled as a special option) uses differential RS422 levels.</p> <p>Phantom v4.1 Cameras provide one asynchronous interface port. The port uses RS422 differential signals. To enable connectivity to RS232 ports, the positive input of the receiver is biased to 2V. This arrangement works well with the majority of RS232 serial ports in use today. However, it shouldn't be expected to operate properly with long cable runs. For such applications, the proper RS422 cabling should be used. There is no internal termination resistor provided on the receiver input.</p>
K	RS-232 TXD (RS-422 TXD -)	<p>Phantom v4.2, v4.3, v5.1, v6.2, v7.1, v7.2, and v9.0 Cameras use true RS232 levels.</p> <p>Phantom v5.0, v6.0, and v7.0 Cameras provide two asynchronous interface ports. The primary port uses true RS232 levels.</p> <p>The secondary port (only enabled as a special option) uses differential RS422 levels.</p> <p>Phantom v4.1 Cameras provide one asynchronous interface port. The port uses RS422 differential signals. To enable connectivity to RS232 ports, the positive input of the receiver is biased to 2V. This arrangement works well with the majority of RS232 serial ports in use today. However, it shouldn't be expected to operate properly with long cable runs. For such applications, the proper RS422 cabling should be used. There is no internal termination resistor provided on the receiver input.</p>
L	+24VDC 1.1 Amp - Phantom v4.2, v4.3, v5.0, v5.1, v6.0, v6.2, v7.0, v7.1, v7.2, and v9.0	Phantom cameras use DC (Direct Current) power. The nominal power supply voltage is 24VDC. The acceptable power supply range is 18-36VDC. Power supply inputs are protected against polarity reversal (with a series-pass diode). The cameras are also protected to under voltage and will shut down when the DC input is below

		+24VDC 0.7 Amp - Phantom v4.1	<p>circa 17VDC.</p> <p>The power supply input terminals are isolated from the case and system ground. This is usually achieved by using a properly isolated power supply.</p> <p>NOTE</p> <p>Connecting the Phantom cameras to anything but a SELV (Safe Extra-Low Voltage) circuit will create an electrical shock hazard.</p> <p>The power supply Power (Watt) Rating should be rated 50% higher than ratings specified (for all camera models).</p>
M		Power Ground	The power input and the acquisition control signals are isolated from the camera system ground. This isolation is designed to avoid system ground loops only, and should not be subject to high voltages.
N		Sync Imaging Frame Sync In/ Frame Sync Out	<p>Bi-directional isolated signal.</p>
P		ISO Ground	
R		Pre-Trigger In/ MemGate In	<p>Pin R of the 19-pin capture connector is shared between the following two functions:</p> <p>MemGate</p> <p>Active-low isolated input. When asserted, the current frame is discarded instead of being written into the memory. The decision is taken at the end of the exposure (after STROBE goes high).</p> <p>MemGate needs to be low the moment STROBE goes high and stays low for at least 15µs to disable recording of the current frame.</p> <p>Pre-Trigger</p> <p>This function allows the user to place the camera into the Ready State or Capture Mode when the falling edge of a 5V TTL pulse is detected via Pin R.</p> <p>Selection of which function as Pin-R should utilize is</p>

		defined via the Live>Advanced Settings>Pretrigger Pin Is setting. NOTE The Pre-Trigger function is not supported by the Phantom v4.1, v5.0, and v7.0 cameras.
S	IRIG Out (Unmodulated)	Phantom v4.2, v4.3, v5.0, v5.1, v6.0, v6.2, v7.0, v7.1, v7.2, and v9.0 Cameras provide unmodulated IRIG B time code inputs and outputs. The input withstands signals of up to +/- 15v. The input threshold is 1.5V, so the input is also compatible with TTL levels. The output swings to RS-232 levels of +/-9V. All IRIG i/os are not isolated. Phantom v4.1 Cameras provide unmodulated IRIG B time code inputs and outputs. The input withstands signals of up to +/- 15v. The input threshold is 1.5V, so the input is also compatible with TTL levels. The output swings between 0 and 5V. All IRIG i/os are not isolated.
T	Reserved (RS-422 RXD +)	Phantom v4.2, v4.3, v5.1, v6.2, v7.1, v7.2, and v9.0 Cameras use true RS232 levels. Phantom v5.0, v6.0, and v7.0 Cameras provide two asynchronous interface ports. The primary port uses true RS232 levels. The secondary port (only enabled as a special option) uses differential RS422 levels. Phantom v4.1 Cameras provide one asynchronous interface port. The port uses RS422 differential signals. To enable connectivity to RS232 ports, the positive input of the receiver is biased to 2V. This arrangement works well with the majority of RS232 serial ports in use today. However, it should not be expected to operate properly with long cable runs. For such applications, the proper RS422 cabling should be used. There is no internal termination resistor provided on the receiver input.
U	RS-232 RXD (RS-422 RXD -)	Phantom v4.2, v4.3, v5.1, v6.2, v7.1, v7.2, and v9.0 Cameras use true RS232 levels. Phantom v5.0, v6.0, and v7.0 Cameras provide two asynchronous interface ports. The primary port uses true RS232 levels. The secondary port (only enabled as a special option) uses differential RS422 levels. Phantom v4.1 Cameras provide one asynchronous interface port. The port uses RS422 differential signals. To enable connectivity to RS232 ports, the positive input of the receiver is biased to 2V. This arrangement works well with the majority of RS232 serial ports in use today. However, it should not be expected to operate properly with long cable runs. For such applications, the proper RS422 cabling should be used. There is no internal termination resistor provided on the receiver input.
V	Ready	Isolated open collector output, with 1k pull-up. When high, indicates that the camera is in capture mode. In a

			multiple camera system, the READY outputs of up to 4 cameras can be connected together; the resulting signal will be high when all the cameras in the system are in capture mode.
--	--	--	---

4.6.11 Phantom CineStation 10G Fiber Optic Connector (SC)

Diode driven light source over multi-mode 50/125micron fiber optic. The connector type is an SC connector for both transmit and receive.

4.6.12 Phantom CineStation Console Connector (RJ-45)

For Vision Research Engineering Use Only.

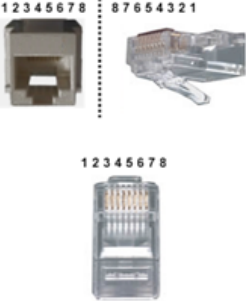
CONNECTOR	PIN	NOMENCLATURE	FUNCTIONAL DESCRIPTION
	1	GND	Ground
	2	GND	Ground
	3	RxD	Receive Data
	4	TxD	Transmit Data
	5	UNUSED	Not Used
	6	UNUSED	Not Used
	7	CGND	Chassis Ground
	8	UNUSED	Not Used

4.6.13 Phantom CineStation Ethernet Connector (RJ-45)

This connector provides a means to connect the controlling laptop or PC to a 10G or 1G CineStation. The Ethernet connector provides connectivity to other cameras in a multi-camera setup.

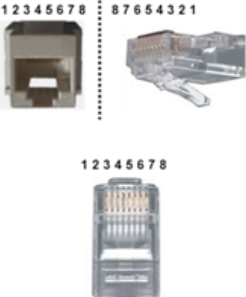
CONNECTOR	PIN	NOMENCLATURE	FUNCTIONAL DESCRIPTION
	1	TRD+(0)	Transmit/Receive Data +0 (positive)
	2	TRD (0)	Transmit/Receive Data -0 (negative)
	3	TRD+(1)	Transmit/Receive Data +1 (positive)
	4	TRD+(2)	Transmit/Receive Data +2 (positive)
	5	TRD (2)	Transmit/Receive Data -2 (negative)
	6	TRD (1)	Transmit/Receive Data -1 (negative)
	7	TRD+(3)	Transmit/Receive Data +3 (positive)

	8	TRD (3)	Transmit/Receive Data -3 (negative)
--	---	---------	-------------------------------------

4.6.14 Phantom CineStation HD-SDI Connectors (BNC)

CONNECTOR	PIN	NOMENCLATURE	FUNCTIONAL DESCRIPTION
 HD-SDI		SDI OUT1	The serial digital interface coaxial cable with BNC connector has a nominal impedance of 75 ohms. This is the same type of cable used in analog video setups, which potentially makes for easier upgrades (though higher quality cables may be necessary for long runs at the higher bit rates). The specified signal amplitude at the source is 800 mV ($\pm 10\%$) peak-to-peak; far lower voltages may be measured at the receiver owing to attenuation. Using equalization at the receiver, it is possible to send 270 Mbit/s SDI over 300 meters without the use of repeaters, but shorter lengths are preferred. The HD bit rates have a shorter maximum run length, typically 100 meters.

4.6.15 Phantom F-SYNC Connector (BNC)

Frame Sync is a bi-directional isolated signal by which the electronic shutter is precisely timed to operate in phase with a timing signal.

CONNECTOR	PIN	NOMENCLATURE	FUNCTIONAL DESCRIPTION
 F-Sync		SYNC	The f-sync signal threshold is +5V maximum, so the input is also compatible with TTL levels and must be a properly terminated, (50-ohms).

4.6.16 Phantom GenLock Connector (BNC)

Used to synchronize the frame capture with an external device.

CONNECTOR	PIN	NOMENCLATURE	FUNCTIONAL DESCRIPTION
 GenLock		GenLock	Used to synchronize the playback to a video signal, utilizing a composite video inbound signal. This video input signal should be a properly terminated, (75-ohm), and the signal must not exceed +1.56V maximum. For anything but the shortest cable runs, quality 75-ohm coax, (e.g. RG59/U), must be used. It will also synch live video, by synchronizing the SDI outputs to the GenLock signal.

4.6.17 Phantom Gigabit Ethernet Connector (RJ45)

This connector provides a means to connect the controlling laptop or PC to your Phantom camera. The Ethernet connector provides connectivity to other cameras in a multi-camera setup.

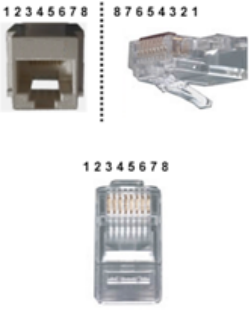
CONNECTOR	PIN	NOMENCLATURE	FUNCTIONAL DESCRIPTION
	1	TRD+(0)	Transmit/Receive Data +0 (positive)
	2	TRD (0)	Transmit/Receive Data -0 (negative)
	3	TRD+(1)	Transmit/Receive Data +1 (positive)
	4	TRD+(2)	Transmit/Receive Data +2 (positive)
	5	TRD (2)	Transmit/Receive Data -2 (negative)
	6	TRD (1)	Transmit/Receive Data -1 (negative)
	7	TRD+(3)	Transmit/Receive Data +3 (positive)
	8	TRD (3)	Transmit/Receive Data -3 (negative)

4.6.18 Phantom Gigabit Ethernet Connector (Revision 3) (8-Pin Male)

This connector provides a means to connect the controlling laptop or PC to your Phantom camera. The Ethernet connector provides connectivity to other cameras in a multi-camera setup.

CONNECTOR	PIN	NOMENCLATURE	FUNCTIONAL DESCRIPTION
	1	MDI2P	10/100/1000BASE-T Media Dependent Interface 2 (positive)
	2	MDI2N	10/100/1000BASE-T Media Dependent Interface 2 (negative)
	3	MDI3P	10/100/1000BASE-T Media Dependent Interface 3 (positive)
	4	MDI3N	10/100/1000BASE-T Media Dependent Interface 3 (negative)
	5	ETHRXP	10/100/1000BASE-T Ethernet Receive (positive)
	6	ETHRXN	10/100/1000BASE-T Ethernet Receive (negative)
	7	ETHTXP	10/100/1000BASE-T Ethernet Transmit (positive)
	8	ETHTXN	10/100/1000BASE-T Ethernet Transmit (negative)

4.6.19 Phantom Gigabit Ethernet Connector (Revision 2) (8-Pin Male)

This connector provides a means to connect the controlling laptop or PC to a Phantom camera. The Ethernet connector

provides connectivity to other cameras in a multi-camera setup.

CONNECTOR	PIN	NOMENCLATURE	FUNCTIONAL DESCRIPTION
	A	MDI2P	10/100/1000BASE-T Media Dependent Interface 2 (positive)
	B	MDI2N	10/100/1000BASE-T Media Dependent Interface 2 (negative)
	C	MDI3P	10/100/1000BASE-T Media Dependent Interface 3 (positive)
	D	MDI3N	10/100/1000BASE-T Media Dependent Interface 3 (negative)
	E	MDI1P	10/100/1000BASE-T Media Dependent Interface 1 (positive)
	F	MDI1N	10/100/1000BASE-T Media Dependent Interface 1 (negative)
	G	MDI0P	10/100/1000BASE-T Media Dependent Interface 0 (positive)
	H	MDI0N	10/100/1000BASE-T Media Dependent Interface 0 (negative)

4.6.20 Phantom Gigabit Ethernet Connector (Revision 1) (6-Pin Male)

This connector provides a means to connect the controlling laptop or PC to a Phantom camera. The Ethernet connector provides connectivity to other cameras in a multi-camera setup.

CONNECTOR	PIN	NOMENCLATURE	FUNCTIONAL DESCRIPTION
	A	ETHTXP	10/100BASE-T Ethernet Transmit Data (positive)
	B	ETHTXN	10/100BASE-T Ethernet Transmit Data (negative)
	C	UNUSED	Not Used
	D	ETHRXP	10/100BASE-T Ethernet Receive Data (positive)
	E	ETHRXN	10/100BASE-T Ethernet Receive Data (negative)
	F	UNUSED	Not Used

4.6.21 Phantom GPS Connector

This connector is used to provide a GPS frame rate clock and timing to the Phantom UHS v-Series camera models.

CONNECTOR	PIN	NOMENCLATURE	FUNCTIONAL DESCRIPTION
	1	PGND	Power Ground
	2	RxD	RS-232 Receive Data
	3	Unused	
	4	+5V/0.2A	Provides +5VDC (Direct Current) positive power to the Phantom camera at 0.2 amps.
	5	pps In	Parts-per-Second In
	6	pps Ground	Parts-per-Second Ground

4.6.22 Phantom HD-SDI Connector (BNC)

CONNECTOR	PIN	NOMENCLATURE	FUNCTIONAL DESCRIPTION
 HD-SDI		SDI OUT1	The serial digital interface coaxial cable with BNC connector has a nominal impedance of 75 ohms. This is the same type of cable used in analog video setups, which potentially makes for easier upgrades (though higher quality cables may be necessary for long runs at the higher bit rates). The specified signal amplitude at the source is 800 mV ($\pm 10\%$) peak-to-peak; far lower voltages may be measured at the receiver owing to attenuation. Using equalization at the receiver, it is possible to send 270 Mbit/s SDI over 300 meters without the use of repeaters, but shorter lengths are preferred. The HD bit rates have a shorter maximum run length, typically 100 meters.

4.6.23 Phantom 3G HD-SDI (BNC)

CONNECTOR	PIN	NOMENCLATURE	FUNCTIONAL DESCRIPTION
 3G HD-SDI		SDIOUT	SDI (Serial Digital Interface) - single-link coaxial cable with a nominal impedance of 75-ohm. The specified signal amplitude at the source is 800 mV ($\pm 10\%$) peak-to-peak (lower voltages may be measured at the receiver owing to attenuation). Allows for bit-rates of 2.970 Gbit/s and 2.970/1.001 Gbit/s (1080p video at 50 or 60 fps) , reliable (without use of repeaters) at able lengths of 100 m (330') using RG6 cable, 60 m (200') using RG59 cable.

4.6.24 Phantom IEEE 1394 Connector (6-Pin Female)

This connector provides a means to connect the controlling laptop or PC to a Phantom camera via the 6-Pin IEEE 1394

connector.

CONNECTOR	PIN	NOMENCLATURE	FUNCTIONAL DESCRIPTION
	A	TXD+	Transmit Data (positive)
	B	TXD-	Transmit Data (negative)
	C	RXD+	Receive Data (positive)
	D	RXD-	Receive Data (negative)
	E	PGND	Power Ground
	F	CHGND	Chassis Ground

4.6.25 Phantom IEEE 1394 Daisy Chain Connector

This connector provides a means to connect the controlling laptop or PC to a Phantom v4.1 camera. A computer link may be plugged into any of the IEEE 1394 connectors. These connectors also provide connectivity to other cameras in a multi camera setup. Up to 62 cameras, along with a Phantom Control Unit, can be daisy chained using these connectors.

CONNECTOR	PIN	NOMENCLATURE	FUNCTIONAL DESCRIPTION
	A	TXD+	Transmit Data (positive)
	B	TXD-	Transmit Data (negative)
	C	RXD+	Receive Data (positive)
	D	RXD-	Receive Data (negative)
	E	PGND	Power Ground
	F	UNUSED	Not Used

4.6.26 Phantom IOIOI Connector (10-Pin Male)

This connector provides a modulated IRIG-B input. Along with outputs such as +5VDC, and RS232 control are also provided in this connector.

CONNECTOR	PIN	NOMENCLATURE	FUNCTIONAL DESCRIPTION
	A	RS232 TXD-	Transmit Data (Negative), (RS-232); +5V maximum, normally limited to 50 feet (16 meters).
	B	B-Mode	Used by VRI Engineering
	C	RS232 RXD+	Receive Data (Positive), (RS-232); +5V maximum, normally limited to 50 feet (16 meters).
	D	Modulated IRIG-B IN	The modulated input is AC-coupled, and will work

			properly with signals of between 3Vpp, (peak-to-peak), and 12Vpp amplitude.
E	+5VDC OUT		+5VDC Output
F	GND		Ground/Shield
G	RS422 RXD-		Receive Data (Negative), (RS-422); +5V maximum. Depending on data transmission rates, RS-422 can be used at distances to 4,000 feet (1,275 meters).
H	RS422 RXD+		Receive Data (Positive), (RS-422); +5V maximum. Depending on data transmission rates, RS-422 can be used at distances to 4,000 feet (1,275 meters).
J	RS422 TXD-		Transmit Data (Negative), (RS-422); +5V maximum. Depending on data transmission rates, RS-422 can be used at distances to 4,000 feet (1,275 meters).
K	RS422 TXD+		Transmit Data (Positive), (RS-422); +5V maximum. Depending on data transmission rates, RS-422 can be used at distances to 4,000 feet (1,275 meters).

4.6.27 Phantom Miro 10/100 Ethernet Connector (8-Pin Female)

This connector provides a means to connect the controlling laptop or PC to a Phantom Miro-Series camera. The Ethernet connector provides connectivity to other cameras in a multi-camera setup.

CONNECTOR	PIN	NOMENCLATURE	FUNCTIONAL DESCRIPTION
	1	UNUSED	Not Used
	2	UNUSED	Not Used
	3	UNUSED	Not Used
	4	UNUSED	Not Used
	5	ETHRX+	10/100BASE-T Ethernet Receive Data (positive)
	6	ETHRX-	10/100BASE-T Ethernet Receive Data (negative)
	7	ETHTX+	10/100BASE-T Ethernet Transmit Data (positive)
	8	ETHTX-	10/100BASE-T Ethernet Transmit Data (negative)

4.6.28 Phantom Miro CompactFlash® Slot

The CompactFlash slot is used to house a removable Type 1 CompactFlash non-volatile memory card used to store recorded images.



The camera will run on battery power if the camera has any image data stored in the camera's RAM. To view the images stored onto the Compact Flash card you will need to use a CompactFlash Card Reader attached to your Phantom Control Unit.

4.6.29 Phantom Miro 1 Capture Connector (12-Pin Male)

CONNECTOR	PIN	NOMENCLATURE	FUNCTIONAL DESCRIPTION
	1	UNUSED	Not Used
	2	UNUSED	Not Used
	3	PGND	The power input and the acquisition control signals are isolated from the camera system ground. This isolation is designed to avoid system ground loops only, and should not be subject to high voltages.
	4	Trigger-In	Isolated input. Active low. It can be activated by a switch to ground. On early cameras, the trigger was level-sensitive, and was accepted if asserted (low) at the end of an exposure. As such, the trigger signal should have lasted at least as much as the reciprocal of the frame rate to guarantee it was recognized. Now the trigger is edge-sensitive, and the exact time of the trigger edge is recorded. The trigger pulse needs to be at least 3 μ s long.
	5	UNUSED	Not Used
	6	UNUSED	Not Used
	7	UNUSED	Not Used
	8	Video GND	Ground/Shield
	9	Video1-Out	The video output of the Phantom cameras is a standard level, 75-ohm output. It is not isolated. The video output should only drive a properly terminated (75-ohm) input. Also, for anything but the shortest cable runs, quality 75-ohm coax (e.g. RG59/U) must be used.
	10	+24VDC-In	Phantom cameras use DC (Direct Current) power. The nominal power supply voltage is +24VDC. The acceptable power supply range is +18 to +36VDC. The cameras are protected to under voltage and will shut down when the DC input is below circa 17VDC. The power supply input terminals are isolated from the case and system ground. This is usually achieved by using a properly isolated power supply.

	11	+24VDC-In	Phantom cameras use DC (Direct Current) power. The nominal power supply voltage is +24VDC. The acceptable power supply range is +18 to +36VDC. The cameras are protected to under voltage and will shut down when the DC input is below circa 17VDC. The power supply input terminals are isolated from the case and system ground. This is usually achieved by using a properly isolated power supply.
	12	UNUSED	Not Used

4.6.30 Phantom Miro 2 Capture Connector (12-Pin Male)

CONNECTOR	PIN	NOMENCLATURE	FUNCTIONAL DESCRIPTION
	1	UNUSED	Not Used
	2	UNUSED	Not Used
	3	PGND	The power input and the acquisition control signals are isolated from the camera system ground. This isolation is designed to avoid system ground loops only, and should not be subject to high voltages.
	4	Trigger-In	Isolated input. Active low. It can be activated by a switch to ground. On early cameras the trigger was level-sensitive, and was accepted if asserted (low) at the end of an exposure. As such, the trigger signal should have lasted at least as much as the reciprocal of the frame rate to guarantee it was recognized. Now the trigger is edge-sensitive, and the exact time of the trigger edge is recorded. The trigger pulse needs to be at least 3µs long.
	5	UNUSED	Not Used
	6	UNUSED	Not Used
	7	UNUSED	Not Used
	8	Video GND	Ground/Shield
	9	Video1-Out	The video output of the Phantom cameras is a standard level, 75-ohm output. It is not isolated. The video output should only drive a properly terminated (75-ohm) input. Also, for anything but the shortest cable runs, quality 75-ohm coax (e.g. RG59/U) must be used.
	10	+24VDC-In	Phantom cameras use DC (Direct Current) power. The nominal power supply voltage is +24VDC. The

			<p>acceptable power supply range is +18 to +36VDC. The cameras are protected to under voltage and will shut down when the DC input is below circa 17VDC.</p> <p>The power supply input terminals are isolated from the case and system ground. This is usually achieved by using a properly isolated power supply.</p>
	11	+24VDC-In	<p>Phantom cameras use DC (Direct Current) power. The nominal power supply voltage is +24VDC. The acceptable power supply range is +18 to +36VDC. The cameras are protected to under voltage and will shut down when the DC input is below circa 17VDC.</p> <p>The power supply input terminals are isolated from the case and system ground. This is usually achieved by using a properly isolated power supply.</p>
	12	Aux (Strobe)	<p>Isolated open collector output, with 1k pull-up. When asserted (low) Strobe indicates that the camera integrates (the shutter is open). Strobe is low for the duration of the exposure.</p>

4.6.31 Phantom Miro 4 Capture Connector (12-Pin Male)

This connector provides all I/O connectivity such as trigger, Ready, Frame Sync, IRIG-In, IRIG-Out, Video Out, and Strobe. Signal supported unless otherwise noted.

CONNECTOR	PIN	NOMENCLATURE	FUNCTIONAL DESCRIPTION
	1	GND	Signal Ground
	2	GND	The power input and the acquisition control signals are isolated from the camera system ground. This isolation is designed to avoid system ground loops only, and should not be subject to high voltages.
	3	GND	The power input and the acquisition control signals are isolated from the camera system ground. This isolation is designed to avoid system ground loops only, and should not be subject to high voltages.
	4	Trigger-In	<p>Isolated input. Active low. It can be activated by a switch to ground. On early cameras the trigger was level-sensitive, and was accepted if asserted (low) at the end of an exposure. As such, the trigger signal should have lasted at least as much as the reciprocal of the frame rate to guarantee it was recognized.</p> <p>Now the trigger is edge-sensitive, and the exact time of the trigger edge is recorded. The trigger pulse needs to be at least 3µs long.</p>
	5	Ready-Out	Isolated open collector output, with 1k pull-up. When

		high, indicates that the camera is in capture mode. In a multiple camera system, the READY outputs of up to 4 cameras can be connected together; the resulting signal will be high when all the cameras in the system are in capture mode.
6	FSYNC	Frame Sync is a bi-directional isolated signal.
7	IRIG-In	All Phantom Miro cameras provide unmodulated IRIG B time code input. The input withstands signals of up to +/- 15v. The input threshold is 1.5V, so the input is also compatible with TTL levels. All IRIG i/os are not isolated.
8	Video GND	Ground/Shield
9	Video1-Out	The video output of the Phantom cameras is a standard level, 75-ohm output. It is not isolated. The video output should only drive a properly terminated (75-ohm) input. Also, for anything but the shortest cable runs, quality 75-ohm coax (e.g. RG59/U) must be used.
10	+24VDC-In	Phantom cameras use DC (Direct Current) power. The nominal power supply voltage is +24VDC. The acceptable power supply range is +18 to +36VDC. The cameras are protected to under voltage and will shut down when the DC input is below circa 17VDC. The power supply input terminals are isolated from the case and system ground. This is usually achieved by using a properly isolated power supply.
11	+24VDC-In	Phantom cameras use DC (Direct Current) power. The nominal power supply voltage is +24VDC. The acceptable power supply range is +18 to +36VDC. The cameras are protected to under voltage and will shut down when the DC input is below circa 17VDC. The power supply input terminals are isolated from the case and system ground. This is usually achieved by using a properly isolated power supply.
12	Aux (Strobe/IRIG-Out)	Isolated open collector output, with 1k pull-up. When asserted (low) Strobe indicates that the camera integrates (the shutter is open). Strobe is low for the duration of the exposure. IRIG-Out: The Phantom Miro 3 and Miro 4 cameras provide unmodulated IRIG-B time code inputs and outputs. The input withstands signals of up to +/- 15v. The input threshold is 1.5V, so the input is also compatible with TTL levels. The output swings to RS-232 levels of +/-9V.

			All IRIG i/os are not isolated.
--	--	--	---------------------------------

4.6.32 Phantom Miro eX1 Capture Connector (12-Pin Male)

	1	UNUSED	Not Used
	2	UNUSED	Not Used
	3	PGND	The power input and the acquisition control signals are isolated from the camera system ground. This isolation is designed to avoid system ground loops only, and should not be subject to high voltages.
	4	Trigger-In	Isolated input. Active low. It can be activated by a switch to ground. On early cameras, the trigger was level-sensitive, and was accepted if asserted (low) at the end of an exposure. As such, the trigger signal should have lasted at least as much as the reciprocal of the frame rate to guarantee it was recognized. Now the trigger is edge-sensitive, and the exact time of the trigger edge is recorded. The trigger pulse needs to be at least 3µs long.
	5	UNUSED	Not Used
	6	UNUSED	Not Used
	7	UNUSED	Not Used
	8	Video GND	Ground/Shield
	9	Video1-Out	The video output of the Phantom cameras is a standard level, 75-ohm output. It is not isolated. The video output should only drive a properly terminated (75-ohm) input. Also, for anything but the shortest cable runs, quality 75-ohm coax (e.g. RG59/U) must be used.
	10	+24VDC-In	Phantom cameras use DC (Direct Current) power. The nominal power supply voltage is +24VDC. The acceptable power supply range is +18 to +36VDC. The cameras are protected to under voltage and will shut down when the DC input is below circa 17VDC. The power supply input terminals are isolated from the case and system ground. This is usually achieved by using a properly isolated power supply.
	11	+24VDC-In	Phantom cameras use DC (Direct Current) power. The nominal power supply voltage is +24VDC. The acceptable power supply range is +18 to +36VDC.

			<p>The cameras are protected to under voltage and will shut down when the DC input is below circa 17VDC.</p> <p>The power supply input terminals are isolated from the case and system ground. This is usually achieved by using a properly isolated power supply.</p>
	12	UNUSED	Not Used

4.6.33 Phantom Miro eX2 Capture Connector (12-Pin Male)

CONNECTOR	PIN	NOMENCLATURE	FUNCTIONAL DESCRIPTION
	1	UNUSED	Not Used
	2	UNUSED	Not Used
	3	PGND	The power input and the acquisition control signals are isolated from the camera system ground. This isolation is designed to avoid system ground loops only, and should not be subject to high voltages.
	4	Trigger-In	<p>Isolated input. Active low. It can be activated by a switch to ground. On early cameras the trigger was level-sensitive, and was accepted if asserted (low) at the end of an exposure. As such, the trigger signal should have lasted at least as much as the reciprocal of the frame rate to guarantee it was recognized.</p> <p>Now the trigger is edge-sensitive, and the exact time of the trigger edge is recorded. The trigger pulse needs to be at least 3µs long.</p>
	5	UNUSED	Not Used
	6	UNUSED	Not Used
	7	UNUSED	Not Used
	8	Video GND	Ground/Shield
	9	Video1-Out	The video output of the Phantom cameras is a standard level, 75-ohm output. It is not isolated. The video output should only drive a properly terminated (75-ohm) input. Also, for anything but the shortest cable runs, quality 75-ohm coax (e.g. RG59/U) must be used.
	10	+24VDC-In	Phantom cameras use DC (Direct Current) power. The nominal power supply voltage is +24VDC. The acceptable power supply range is +18 to +36VDC. The cameras are protected to under voltage and will shut down when the DC input is below circa 17VDC.

			The power supply input terminals are isolated from the case and system ground. This is usually achieved by using a properly isolated power supply.
	11	+24VDC-In	Phantom cameras use DC (Direct Current) power. The nominal power supply voltage is +24VDC. The acceptable power supply range is +18 to +36VDC. The cameras are protected to under voltage and will shut down when the DC input is below circa 17VDC. The power supply input terminals are isolated from the case and system ground. This is usually achieved by using a properly isolated power supply.
	12	Aux (Strobe)	Isolated open collector output, with 1k pull-up. When asserted (low) Strobe indicates that the camera integrates (the shutter is open). Strobe is low for the duration of the exposure.

4.6.34 Phantom Miro eX4, Miro 3, and Miro Airborne/AirborneHD Capture Connector (12-Pin Male)

This connector provides all I/O connectivity such as trigger, Ready, Frame Sync, IRIG-In, IRIG-Out, Video Out, and Strobe. Signal supported unless otherwise noted.

CONNECTOR	PIN	NOMENCLATURE	FUNCTIONAL DESCRIPTION
	1	GND	Signal Ground
	2	GND	The power input and the acquisition control signals are isolated from the camera system ground. This isolation is designed to avoid system ground loops only, and should not be subject to high voltages.
	3	GND	The power input and the acquisition control signals are isolated from the camera system ground. This isolation is designed to avoid system ground loops only, and should not be subject to high voltages.
	4	Trigger-In	Isolated input. Active low. It can be activated by a switch to ground. On early cameras the trigger was level-sensitive, and was accepted if asserted (low) at the end of an exposure. As such, the trigger signal should have lasted at least as much as the reciprocal of the frame rate to guarantee it was recognized. Now the trigger is edge-sensitive, and the exact time of the trigger edge is recorded. The trigger pulse needs to be at least 3µs long.
	5	Ready-Out	Isolated open collector output, with 1k pull-up. When high, indicates that the camera is in capture mode. In a multiple camera system, the READY outputs of up to 4 cameras can be connected together; the resulting

		signal will be high when all the cameras in the system are in capture mode.
6	FSYNC	Frame Sync is a bi-directional isolated signal.
7	IRIG-In	All Phantom Miro cameras provide unmodulated IRIG B time code input. The input withstands signals of up to +/- 15v. The input threshold is 1.5V, so the input is also compatible with TTL levels. All IRIG i/os are not isolated.
8	Video GND	Ground/Shield
9	Video1-Out	The video output of the Phantom cameras is a standard level, 75-ohm output. It is not isolated. The video output should only drive a properly terminated (75-ohm) input. Also, for anything but the shortest cable runs, quality 75-ohm coax (e.g. RG59/U) must be used.
10	+24VDC-In	Phantom cameras use DC (Direct Current) power. The nominal power supply voltage is +24VDC. The acceptable power supply range is +18 to +36VDC. The cameras are protected to under voltage and will shut down when the DC input is below circa 17VDC. The power supply input terminals are isolated from the case and system ground. This is usually achieved by using a properly isolated power supply.
11	+24VDC-In	Phantom cameras use DC (Direct Current) power. The nominal power supply voltage is +24VDC. The acceptable power supply range is +18 to +36VDC. The cameras are protected to under voltage and will shut down when the DC input is below circa 17VDC. The power supply input terminals are isolated from the case and system ground. This is usually achieved by using a properly isolated power supply.
12	Aux (Strobe/IRIG-Out)	Isolated open collector output, with 1k pull-up. When asserted (low) Strobe indicates that the camera integrates (the shutter is open). Strobe is low for the duration of the exposure. IRIG-Out: The Phantom Miro 3 and Miro 4 cameras provide unmodulated IRIG-B time code inputs and outputs. The input withstands signals of up to +/- 15v. The input threshold is 1.5V, so the input is also compatible with TTL levels. The output swings to RS-232 levels of +/-9V. All IRIG i/os are not isolated.

4.6.35 Phantom Miro M / R /LC Series Capture Connector (12-Pin Male)

This connector provides all I/O connectivity such as trigger, Ready, Frame Sync, IRIG-In, IRIG-Out, Video Out, and Strobe. Signal supported unless otherwise noted.

CONNECTOR	PIN	NOMENCLATURE	FUNCTIONAL DESCRIPTION
	1	GND	Signal Ground
	2	GND	The power input and the acquisition control signals are isolated from the camera system ground. This isolation is designed to avoid system ground loops only, and should not be subject to high voltages.
	3	GND	The power input and the acquisition control signals are isolated from the camera system ground. This isolation is designed to avoid system ground loops only, and should not be subject to high voltages.
	4	Trigger-In	<p>Isolated input. Active low. It can be activated by a switch to ground. On early cameras the trigger was level-sensitive, and was accepted if asserted (low) at the end of an exposure. As such, the trigger signal should have lasted at least as much as the reciprocal of the frame rate to guarantee it was recognized.</p> <p>Now the trigger is edge-sensitive, and the exact time of the trigger edge is recorded. The trigger pulse needs to be at least 3µs long.</p>
	5	Ready-Out	Isolated open collector output, with 1k pull-up. When high, indicates that the camera is in capture mode. In a multiple camera system, the READY outputs of up to 4 cameras can be connected together; the resulting signal will be high when all the cameras in the system are in capture mode.
	6	Aux (Strobe/Event/ Memory Gate)	<p>Isolated open collector output, with 1k pull-up. When asserted (low) Strobe indicates that the camera integrates (the shutter is open). Strobe is low for the duration of the exposure.</p> <p>Event is an active-low isolated input whose state is recorded at the end of each exposure. The signal must be active when the strobe goes high, and be at least 30µs long to guarantee it is properly recorded.</p> <p>MemGate is an active-low isolated input. When asserted, the current frame is discarded instead of being written into the memory. The decision is taken at the end of the exposure (after STROBE goes high).</p> <p>MemGate needs to be low the moment STROBE goes high and stays low for at least 15µs to disable recording of the current frame.</p>

	7	IRIG-In	All Phantom Miro cameras provide unmodulated IRIG B time code input. The input withstands signals of up to +/- 15v. The input threshold is 1.5V, so the input is also compatible with TTL levels. All IRIG i/os are not isolated.
	8	Video GND	Ground/Shield
	9	Video1-Out	The video output of the Phantom cameras is a standard level, 75-ohm output. It is not isolated. The video output should only drive a properly terminated (75-ohm) input. Also, for anything but the shortest cable runs, quality 75-ohm coax (e.g. RG59/U) must be used.
	10	+24VDC-In	Phantom cameras use DC (Direct Current) power. The nominal power supply voltage is +24VDC. The acceptable power supply range is +18 to +36VDC. The cameras are protected to under voltage and will shut down when the DC input is below circa 17VDC. The power supply input terminals are isolated from the case and system ground. This is usually achieved by using a properly isolated power supply.
	11	+24VDC-In	Phantom cameras use DC (Direct Current) power. The nominal power supply voltage is +24VDC. The acceptable power supply range is +18 to +36VDC. The cameras are protected to under voltage and will shut down when the DC input is below circa 17VDC. The power supply input terminals are isolated from the case and system ground. This is usually achieved by using a properly isolated power supply.
	12	IRIG Out	Phantom Miro M-Series can provide unmodulated IRIG B time code outputs. The output swings to RS-232 levels of +/-9V. All IRIG i/os are not isolated.

4.6.36 Phantom Miro C-Series Capture Cable (12-Pin Male)

This connector provides all I/O connectivity such as trigger, Ready, Frame Sync, IRIG-In, IRIG-Out, Video Out, and Strobe. Signal supported unless otherwise noted.

CONNECTOR	PIN	NOMENCLATURE	FUNCTIONAL DESCRIPTION
	1	IOGND	Signal Ground
	2	IOGND	Signal Ground
	3	IOGND	Signal Ground

	4	Trigger-In	Isolated Input. Active low. Can be activated by a switch to ground. The trigger pulse needs to be at least 3 microseconds long. Capture cable = Red
	5	AUX 2	Isolated collector output with 1k pull-up. Switchable between READY / STROBE. Capture cable = Green
	6	AUX 1	Isolated collector output. Switchable between STROBE, EVENT, MEMGATE and F-SYNC. Capture cable = Black
	7	TCIN	Timecode Input can accept IRIG-B and SMPTE standards. Capture cable = White
	8	GND	Reference Pin 9
	9	Video1-Out	Standard level, 75-ohm output; not isolated. Output should only drive a properly terminated (75-ohm) input. For anything but the shortest runs, quality 75-ohm coax (e.g. RG59/U) must be used. Capture cable = Black
	10	Power	Nominal power supply voltage is +24VDC (acceptable range is 16-36VDC).
	11	Power	Reference Pin 10
	12	TCOUT	Timecode Output for IRIG-B or SMPTE timecode. IRIG Swings to RS-232 levels of +/- 9V. Capture cable = Blue

4.6.37 Phantom Miro C110 Gigabit Ethernet Connector (RJ-45)

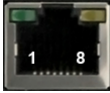
CONNECTOR	PIN	NOMENCLATURE	FUNCTIONAL DESCRIPTION
	1	MDI2+	Medium-Dependent Interface 2 (positive)
	2	MDI-2	Medium-Dependent Interface 2 (negative)
	3	MDI3+	Medium-Dependent Interface 3 (positive)
	4	MDI3-	Medium-Dependent Interface 3 (negative)
	5	MDI1+	Medium-Dependent Interface 1 (positive)
	6	MDI1-	Medium-Dependent Interface 1 (negative)
	7	MDI0+	Medium-Dependent Interface 0 (positive)
	8	MDI0-	Medium-Dependent Interface 0 (negative)

4.6.38 Phantom Miro C110 Trigger, SDI, I/O 1, and I/O 2 Connector (BNC)

	CONNECTOR	FUNCTIONAL DESCRIPTION
	Trigger	Input: when a TTL pulse (rising / falling edge) is detected, camera triggers.
	SDI	Output: for HD video.
	I/O 1	Input / Output: switcable via PCC: <ul style="list-style-type: none"> • STROBE (output): Signal goes low for the duration of each frame's exposure. • EVENT (input): When the Event signal is active, frames are tagged with an Event marker (as metadata). These events can be searched or referenced during playback. • MEMGATE (input): When Memgate signal is active the camera stops recording into it's internal memory (frames are discarded). • F-SYNC (input / output): Connect an external source, including the F-Sync from a second Phantom camera, to drive the camera's frame rate. Use in combination with Sync: External in the External Sync menu.
	I/O 2	Input / Output: switcable via PCC: <ul style="list-style-type: none"> • READY (output) When signal is high it indicates that the camera is in capture mode. Using PCC, signal can be set to go low at trigger or at the end of recording. • STROBE (see Aux 1 description above).

4.6.39 Phantom Miro C110 Power Connector (3-Pin Male)

CONNECTOR	PIN	NOMENCLATURE	FUNCTIONAL DESCRIPTION
	1	VDC	Provides DC (Direct Current) positive power to the Phantom camera. Valid voltage ranges are +16-28VDC
	2	CHGND	Chassis Ground
	3	PGND	Power Ground

4.6.40 Phantom Miro C210 Power Connector (6-Pin Male)

This connector is used to provide the necessary power (+16-28VDC) to the camera.

CONNECTOR	PIN	NOMENCLATURE	FUNCTIONAL DESCRIPTION
	1	PGND	Power Ground

	2	+VINBF	The +VDC In (Battery Freed) connector provides +24VDC (Direct Current) positive power to the Phantom camera.
	3	RXD1	RS-232 Receive Data 1
	4	TXD1	RS-232 Transmit Data 1
	5	Unused	Unused
	6	GND	Ground

4.6.41 Phantom Miro C210J Remote Connectors

CONNECTOR	PIN	NOMENCLATURE	FUNCTIONAL DESCRIPTION
	1	PGND	Power Ground
	2	+VINBF	The +VDC In (Battery Freed) connector provides +24VDC (Direct Current) positive power to the Phantom camera.
	3	RxD1	RS-232 Receive Data 1
	4	TxD1	RS-232 Transmit Data 1
	5	UNUSED	UNUSED
	6	GND	Ground

4.6.42 Phantom Miro C210J System Connectors

This connector provides all I/O connectivity such as trigger, Ready, Frame Sync, IRIG-In, IRIG-Out, Video Out, and Strobe. Signal supported unless otherwise noted.

CONNECTOR	PIN	NOMENCLATURE	FUNCTIONAL DESCRIPTION
	1	IOGND	Signal Ground
	2	IOGND	Signal Ground
	3	IOGND	Signal Ground
	4	TRIGIN-	Trigger input (neg) from J-Box
	5	READYOUT-	Switchable Ready / Strobe output (neg) to J-Box.
	6	IRIGIN+	IRIG input (negative) from J-Box
	7	AUXIN+	Strobe / Event / Memgate / Fsync input (positive) from J-Box

8	CBLDET	Cable detect. Connect to GND in connector.
9	PWRIN_A	+20-32 VDC input from J-Box
10	MDI2-	Gigabit Ethernet
11	MDI1-	Gigabit Ethernet
12	MDI0-	Gigabit Ethernet
13	UNUSED	UNUSED
14	TRIGIN+	Trigger input (pos) from J-Box
15	READYOUT+	Ready output (pos) to J-Box
16	IRIGOUT+	IRIG output (pos) to J-Box
17	IRIGOUT-	IRIG output (neg) to J-Box
18	IRIGIN+	IRIG input (pos) from J-Box
19	AUXIN-	Strobe / Event / Memgate / Fsync input (neg) from J-Box
20	UNUSED	UNUSED
21	PWRIN_B	+20-32 VDC input from J-Box
22	PWRIN_C	+20-32 VDC input from J-Box
23	MDI3+	Gigabit Ethernet
24	MDI3-	Gigabit Ethernet
25	MDI2+	Gigabit Ethernet
26	MDI1+	Gigabit Ethernet
27	MDI0+	Gigabit Ethernet

4.6.43 Phantom Miro N5 CoaXPress (CXP) Connector

The Phantom N5 camera's CXP Cable connector connects to CoaXPress (CXP) connector on a Miro N-Junction Box (N-JB) Base.

4.6.44 Phantom Miro N-JB CoaXPress (CXP) / SDI Connectors (BNC)

	CONNECTOR	FUNCTIONAL DESCRIPTION
	CoaXPress (CXP)	Connects to CoaXPress (CXP) connector on a Miro N-Series camera head.
	HD SDI	Output: for HD video.

4.6.45 Phantom Miro N-JB Remote Connector (6-Pin Fischer)

CONNECTOR	PIN	NOMENCLATURE	FUNCTIONAL DESCRIPTION
	1	PGND	Power Ground
	2	+VINBF	The +VDC In (Battery Freed) connector provides +24VDC (Direct Current) positive power to the Phantom camera.
	3	RxD1	RS-232 Receive Data 1
	4	TxD1	RS-232 Transmit Data 1
	5	Unused	Unused
	6	GND	Ground

4.6.46 Phantom Miro N-JB System Connector (27-Pin Fischer)

CONNECTOR	PIN	NOMENCLATURE	FUNCTIONAL DESCRIPTION
	1	GND	Power Ground
	2	GND	Power Ground
	3	GND	Power Ground
	4	TRIGIN-	Trigger input (neg) from J-Box
	5	READYOUT-	Ready / Strobe output (neg) to J-Box
	6	IRIGIN-	IRIG input (negative) from J-Box
	7	AUXIN+	Strobe / Event / Memgate / Fsync input (positive) from J-Box

8	CBLDET	Cable detect. Connect to GND in connector.
9	PWRIN_A	+20-32 VDC input from J-Box
10	MDI2-	Medium-Dependent Interface 2 (negative)
11	MDI1-	Medium-Dependent Interface 1 (negative)
12	MDI0-	Medium-Dependent Interface 0 (negative)
13	UNUSED	Unused
14	TRIGIN+	Trigger input (pos) from J-Box
15	READYOUT+	Ready output (pos) to J-Box
16	IRIGOUT+	IRIG output (pos) to J-Box
17	IRIGOUT-	IRIG output (neg) to J-Box
18	IRIGIN+	IRIG input (pos) to J-Box
19	AUXIN-	Strobe / Event / Memgate / Fsync input (negative) from J-Box
20	UNUSED	Unused
21	PWRIN_B	+20-32 VDC input from J-Box
22	PWRIN_C	+20-32 VDC input from J-Box
23	MDI3+	Medium-Dependent Interface 3 (positive)
24	MDI3-	Medium-Dependent Interface 3 (negative)
25	MDI2+	Medium-Dependent Interface 2 (positive)
26	MDI1+	Medium-Dependent Interface 1 (positive)
27	MDI0+	Medium-Dependent Interface 0 (positive)

4.6.47 Phantom Miro Mini Breakout Box Connectors

These connectors provides all I/O connectivity such as trigger, Ready, Frame Sync, IRIG-In, IRIG-Out, Video Out, and Strobe. Signal supported unless otherwise noted.

CONNECTOR	NOMENCLATURE	FUNCTIONAL DESCRIPTION
	1. Video Out	BNC connector outputs an analog video signal (NTSC / PAL) to external monitor.
	2. TC In	TC In (input): Connects to an IRIG receiver to accept a modulated or unmodulated signal to drive the camera's frame rate.
	3. TC Out	TC Out (output): Connect a second Phantom camera, to drive the camera's frame rate. Use in combination with Sync: Lock to IRIG in the External Sync menu.
	4. Aux 1	Aux 1 (input / output switchable): STROBE (output): Signal goes low for the duration of each frame's exposure. EVENT (input): When the Event signal is active, frames are tagged with an Event marker (as metadata). These events can be searched or referenced during playback. MEMGATE (input): When Memgate signal is active the camera stops recording into it's internal memory (frames are discarded). F-SYNC (input / output): Connect an external source, including the F-Sync from a second Phantom camera, to drive the camera's frame rate. Use in combination with Sync: External in the External Sync menu.
	5. Aux 2	Aux: 2: (output switchable): READY (output) When signal is high it indicates that the camera is in capture mode. Using PCC, signal can be set to go low at trigger or at the end of recording. STROBE (see Aux 1 description above).
	6. Trigger	Trigger (input): When a TTL pulse (rising / falling edge) is detected, the camera triggers.

4.6.48 Phantom Miro Junction Box Connectors

These connectors provides all I/O connectivity such as trigger, Ready, Frame Sync, IRIG-In, IRIG-Out, Video Out, and Strobe. Signal supported unless otherwise noted.

CONNECTOR	PIN	NOMENCLATURE	FUNCTIONAL DESCRIPTION
	1	Ready	BNC connector; closed for ready, 'open' for not ready; covers all cameras connected to this JBox and any JBox up-chain of this one.
	2	Trigger	BNC connector; contact closure causes trigger. BNC connector also accepts TTL pulses (rising / falling edge) for trigger. There is also Trigger on System

			connector: isolated, <1V deassert, 3 to 24V assert.
	3	Aux	RS-232BNC connector (input/output): Selectable strobe or FSYNC for synchronization with equipment such as pulsed LED lighting. Receive Data 1

CONNECTOR	PIN	NOMENCLATURE	FUNCTIONAL DESCRIPTION
 <p>Ethernet</p>	1	MDI2+	10/100/1000BASE-T Media Dependent Interface 2 (positive)
	2	MDI2-	10/100/1000BASE-T Media Dependent Interface 2 (negative)
	3	MDI3+	10/100/1000BASE-T Media Dependent Interface 3 (positive)
	4	MDI3-	10/100/1000BASE-T Media Dependent Interface 3 (negative)
	5	MDI1+	10/100/1000BASE-T Media Dependent Interface 1 (positive)
	6	MDI1-	10/100/1000BASE-T Media Dependent Interface 1 (negative)
	7	MDI0+	10/100/1000BASE-T Media Dependent Interface 0 (positive)
	8	MDI0-	10/100/1000BASE-T Media Dependent Interface 0 (negative)

CONNECTOR	PIN	NOMENCLATURE	FUNCTIONAL DESCRIPTION
Same Fischer connector as Camera port. Connects to a Camera Port on second JBox to daisy chain or branch the system for additional cameras.			
 <p>System</p>	1	GND	Power Ground
	2	GND	Power Ground
	3	GND	Power Ground
	4	TRIGIN-	Trigger input (neg) from J-Box
	5	READYOUT-	Ready / Strobe output (neg) to J-Box
	6	IRIGIN-	IRIG input (negative) from J-Box
	7	AUXIN+	Strobe / Event / Memgate / Fsync input (positive) from J-Box
	8	CBLDET	Cable detect. Connect to GND in connector.

	9	PWRIN_A	+20-32 VDC input from J-Box
	10	MDI2-	MDI2- Gigabit Ethernet
	11	MDI1-	MDI1- Gigabit Ethernet
	12	MDI0-	MDI0- Gigabit Ethernet
	13	UNUSED	Not used
	14	TRIGIN+	Trigger input (pos) from J-Box
	15	READYOUT+	Ready output (pos) to J-Box
	16	IRIGOUT+	IRIG output (pos) to J-Box
	17	IRIGOUT-	IRIG output (neg) to J-Box
	18	IRIGIN+	IRIG input (pos) from J-Box
	19	AUXIN-	Strobe / Event / Memgate / Fsync input (neg) from J-Box
	20	UNUSED	Not used.
	21	PWRIN_B	+20-32 VDC input from J-Box
	22	PWRIN_C	+20-32 VDC input from J-Box
	23	MDI3+	MDI3+ Gigabit Ethernet
	24	MDI3-	MDI3- Gigabit Ethernet
	25	MDI2+	MDI2+ Gigabit Ethernet
	26	MDI1+	MDI1+ Gigabit Ethernet
	27	MDI0+	MDI0+ Gigabit Ethernet

CONNECTOR	PIN	NOMENCLATURE	FUNCTIONAL DESCRIPTION
Protected for reverse polarity, over-current (10A), under-voltage and over-voltage to 50V. Independent power is required for each Junction Box.			
 Power 20-32VDC	1	+24VB	Connects to a +24VDC battery running parallel to power source
	2	CHGND	Chassis Ground
	3	GND	Power Ground
	4	+24VDC	+24VDC (direct current) to J-Box runs parallel with an optional +24VDC battery

CONNECTOR	PIN	NOMENCLATURE	FUNCTIONAL DESCRIPTION
Fischer connectors; each Miro JBox has six (1- 6) Camera ports which carry Ethernet, power, serial, and Miro camera signals on capture connector. There are two status LEDs for each camera port – Ethernet and camera status. One port can be used to daisy chain or branch to another JBox's System port.			
 <p>Camera</p>	1	GND	Power Ground
	2	GND	Power Ground
	3	GND	Power Ground
	4	TRIGIN-	Trigger input (neg) to camera
	5	READYOUT-	Ready / Strobe output (neg) from camera
	6	IRIGIN-	IRIG input (negative) to camera
	7	AUXIN+	Strobe / Event / Memgate / Fsync input (positive) to camera
	8	CBLDET	Cable detect. Connect to GND in connector.
	9	PWRIN_A	+20-32 VDC input from J-Box
	10	MDI2-	MDI2- Gigabit Ethernet
	11	MDI1-	MDI1- Gigabit Ethernet
	12	MDI0-	MDI0- Gigabit Ethernet
	13	UNUSED	Not used
	14	TRIGIN+	Trigger input (pos) to camera
	15	READYOUT+	Ready output (pos) from camera
	16	IRIGOUT+	IRIG output (pos) from camera
	17	IRIGOUT-	IRIG output (neg) from camera
	18	IRIGIN+	IRIG input (pos) to camera
	19	AUXIN-	Strobe / Event / Memgate / Fsync input (neg) to camera
	20	UNUSED	Not used.
	21	PWRIN_B	+20-32 VDC input to camera
	22	PWRIN_C	+20-32 VDC input to camera
	23	MDI3+	MDI3+ Gigabit Ethernet
	24	MDI3-	MDI3- Gigabit Ethernet

	25	MDI2+	MDI2+ Gigabit Ethernet
	26	MDI1+	MDI1+ Gigabit Ethernet
	27	MDI0+	MDI0+ Gigabit Ethernet

4.6.49 Phantom Miro Mx40 Capture Connector (12-Pin Male)

This connector provides all I/O connectivity such as trigger, Ready, Frame Sync, IRIG-In, IRIG-Out, and Strobe. Signal supported unless otherwise noted.

CONNECTOR	PIN	NOMENCLATURE	FUNCTIONAL DESCRIPTION
	1	GND	Signal Ground
	2	GND	The power input and the acquisition control signals are isolated from the camera system ground. This isolation is designed to avoid system ground loops only, and should not be subject to high voltages.
	3	GND	The power input and the acquisition control signals are isolated from the camera system ground. This isolation is designed to avoid system ground loops only, and should not be subject to high voltages.
	4	Trigger-In	Isolated input. Active low. It can be activated by a switch to ground. On early cameras the trigger was level-sensitive, and was accepted if asserted (low) at the end of an exposure. As such, the trigger signal should have lasted at least as much as the reciprocal of the frame rate to guarantee it was recognized. Now the trigger is edge-sensitive, and the exact time of the trigger edge is recorded. The trigger pulse needs to be at least 3μs long.
	5	Ready-Out	Isolated open collector output, with 1k pull-up. When high, indicates that the camera is in capture mode. In a multiple camera system, the READY outputs of up to 4 cameras can be connected together; the resulting signal will be high when all the cameras in the system are in capture mode.
	6	Aux (Strobe/Event/ Memory Gate)	Isolated open collector output, with 1k pull-up. When asserted (low) Strobe indicates that the camera integrates (the shutter is open). Strobe is low for the duration of the exposure. Event is an active-low isolated input whose state is recorded at the end of each exposure. The signal must be active when the strobe goes high, and be at least 30μs long to guarantee it is properly recorded. MemGate is an active-low isolated input. When

			asserted, the current frame is discarded instead of being written into the memory. The decision is taken at the end of the exposure (after STROBE goes high). MemGate needs to be low the moment STROBE goes high and stays low for at least 15 μ s to disable recording of the current frame.
	7	IRIG-In	All Phantom Miro cameras provide unmodulated IRIG B time code input. The input withstands signals of up to +/- 15v. The input threshold is 1.5V, so the input is also compatible with TTL levels. All IRIG i/os are not isolated.
	8	Unused	Unused
	9	Unused	Unused
	10	+24VDC-In	Phantom cameras use DC (Direct Current) power. The nominal power supply voltage is +24VDC. The acceptable power supply range is +18 to +36VDC. The cameras are protected to under voltage and will shut down when the DC input is below circa 17VDC. The power supply input terminals are isolated from the case and system ground. This is usually achieved by using a properly isolated power supply.
	11	+24VDC-In	Phantom cameras use DC (Direct Current) power. The nominal power supply voltage is +24VDC. The acceptable power supply range is +18 to +36VDC. The cameras are protected to under voltage and will shut down when the DC input is below circa 17VDC. The power supply input terminals are isolated from the case and system ground. This is usually achieved by using a properly isolated power supply.
	12	IRIG Out	Phantom Miro Mx40 Series cameras can provide an unmodulated IRIG B time code outputs. The output swings to RS-232 levels of +/-9V. All IRIG i/os are not isolated.

4.6.50 Phantom v4.1 Power/Capture Connector (19-Pin Male)

This connector provides all the inputs such as the 24VDC power, trigger, unmodulated IRIG-B, frame sync, and event marker. In addition, it also provides outputs such as strobe sync, IRIG-B, RS170 video and frame sync. RS232 control is also provided in this connector.

All acquisition control signals are isolated from the camera ground. They are referred to the signal OVISO, which is connected to the shells of all BNCs in the breakout cables.

The outputs are an open collector, each having a 1kohm pull-up to an isolated 5V supply. The maximum sink current of the outputs is 20mA. The inputs go to opto-coupler LEDs in series with 470

ohms to +5V. To assert a signal, it needs to be pulled down below 2V.

CONNECTOR	PIN	NOMENCLATURE	FUNCTIONAL DESCRIPTION
	A	Event Marker	Event is an active-low isolated input whose state is recorded at the end of each exposure. The signal must be active when the strobe goes high, and be at least 30us long to guarantee it is properly recorded.
	B	Trigger In	<p>Isolated input. Active low. It can be activated by a switch to ground. On early cameras (before version xxx) the trigger was level-sensitive, and was accepted if asserted (low) at the end of an exposure. As such, the trigger signal should have lasted at least as much as the reciprocal of the frame rate to guarantee it was recognized.</p> <p>On cameras with version xxx and above, the trigger is falling edge-sensitive, and the exact time of the trigger edge is recorded. The trigger pulse needs to be at least 3us long.</p>
	C	Strobe Out	Isolated open collector output, with 1k pull-up. When asserted (low) Strobe indicates that the camera integrates (the shutter is open). Strobe is low for the duration of the exposure.
	D	IRIG- In (Unmodulated)	V4.1 Cameras provide unmodulated IRIG B time code inputs and outputs. The input withstands signals of up to +/- 15v. The input threshold is 1.5V, so the input is also compatible with TTL levels. The output swings between 0 and 5V. All IRIG i/os are not isolated.
	E	IRIG Ground	Ground
	F	Video Out (Composite)	The video output of the Phantom cameras is a standard level, 75-ohm output. It is not isolated. The video output should only drive a properly terminated (75-ohm) input. Also, for anything but the shortest cable runs, quality 75-ohm coax (e.g. RG59/U) must be used.
	G	Video Ground (Composite)	Ground/Shield
	H		
	J	RS-232 GND (RS-422 GND)	All the serial ports are not isolated (referred to system ground). As such, they should only be connected to properly earthed equipment.
	K	Reserved (RS-422 TXD +)	V4.1 Cameras provide one asynchronous interface port. The port uses RS422 differential signals. To enable connectivity to RS232 ports, the positive input of the receiver is biased to 2V. This arrangement

		works well with the majority of RS232 serial ports in use today. However, it shouldn't be expected to operate properly with long cable runs. For such applications, the proper RS422 cabling should be used. There is no internal termination resistor provided on the receiver input.
L	+24VDC 0.7 Amp	<p>NOTE</p> <p>The power supply Power (Watt) Rating should be rated 50% higher than ratings specified.</p> <p>Phantom cameras use DC power. The nominal power supply voltage is 24VDC. The acceptable power supply range is 18-36VDC. Power supply inputs are protected against polarity reversal (with a shunt diode fused by a 1.25A PTC reset able fuse). The cameras are also protected to under voltage and will shut down when the dc input is below circa 17VDC.</p> <p>The power supply input terminals are isolated from the case and system ground. This is usually achieved by using a properly isolated power supply.</p> <p>Please note that connecting the Phantom cameras to anything but a SELV (Safe Extra-Low Voltage) circuit will create an electrical shock hazard.</p>
M	Power Ground	The power input and the acquisition control signals are isolated from the camera system ground. This isolation is designed to avoid system ground loops only, and should not be subject to high voltages.
N	Sync Imaging Frame Sync In	Bi-directional isolated signal.
P	ISO Ground	Ground/Shield
R	MemGate In	<p>Active-low isolated input. When asserted, the current frame is discarded instead of being written into the memory. The decision is taken at the end of the exposure (after STROBE goes high).</p> <p>MEMGATE needs to be low the moment STROBE goes high and stays low for at least 15us to disable recording of the current frame.</p>
S	IRIG Out (Unmodulated)	V4.1 Cameras provide unmodulated IRIG B time code inputs and outputs. The input withstands signals of up to +/- 15v. The input threshold is 1.5V, so the input is also compatible with TTL levels. The output swings between 0 and 5V. All IRIG i/os are not isolated.
T	Reserved (RS-422 RXD +)	V4.1 Cameras provide one asynchronous interface port. The port uses RS422 differential signals. To enable connectivity to RS232 ports, the positive input of the receiver is biased to 2V. This arrangement

			works well with the majority of RS232 serial ports in use today. However, it shouldn't be expected to operate properly with long cable runs. For such applications, the proper RS422 cabling should be used. There is no internal termination resistor provided on the receiver input.
	U	RS-232 RXD (RS-422 RXD -)	V4.1 Cameras provide one asynchronous interface port. The port uses RS422 differential signals. To enable connectivity to RS232 ports, the positive input of the receiver is biased to 2V. This arrangement works well with the majority of RS232 serial ports in use today. However, it shouldn't be expected to operate properly with long cable runs. For such applications, the proper RS422 cabling should be used. There is no internal termination resistor provided on the receiver input.
	V	Ready	Isolated open collector output, with 1k pull-up. When high, indicates that the camera is in capture mode. In a multiple camera system, the READY outputs of up to 4 cameras can be connected together; the resulting signal will be high when all the cameras in the system are in capture mode.

4.6.51 Phantom Miro Power Connector (6-Pin Male)

This connector is used to provide the necessary power (+24VDC) to the camera.

CONNECTOR	PIN	NOMENCLATURE	FUNCTIONAL DESCRIPTION
	1	PGND	Power Ground
	2	+24VDC	Provides +24VDC (Direct Current) positive power to the Phantom camera.
	3	RXD	RS-232 Receive Data
	4	TXD	RS-232 Transmit Data
	5	Video2	The video output of the Phantom cameras is a standard level, 75-ohm output. It is not isolated. The video output should only drive a properly terminated (75-ohm) input. Also, for anything but the shortest cable runs, quality 75-ohm coax (e.g. RG59/U) must be used.
	6	GND	Ground

4.6.52 Phantom Miro LAB Series BNC Connectors

These connectors provides I/O connectivity.

CONNECTOR	PIN	NOMENCLATURE	FUNCTIONAL DESCRIPTION
 <ol style="list-style-type: none"> 1. I/O-1 2. I/O-2 3. IRIG-In 4. Trigger 	1	I/O-1	<p>I/O-1 (input / output switchable):</p> <p>STROBE (output): Signal goes low for the duration of each frame's exposure.</p> <p>EVENT (input): When the Event signal is active, frames are tagged with an Event marker (as metadata). These events can be searched or referenced during playback.</p> <p>MEMGATE (input): When Memgate signal is active the camera stops recording into it's internal memory (frames are discarded).</p> <p>F-SYNC (input / output): Connect an external source, including the F-Sync from a second Phantom camera, to drive the camera's frame rate. Use in combination with Sync: External in the External Sync menu.</p>
	2	I/O-2	<p>I/O-2: (output switchable):</p> <p>READY (output) When signal is high it indicates that the camera is in capture mode. Using PCC, signal can be set to go low at trigger or at the end of recording.</p> <p>STROBE (see Aux 1 description above).</p>
	3	IRIG-In	IRIG-In (input): Connects to an IRIG receiver to accept a modulated or unmodulated signal to drive the camera's frame rate.
	4	Trigger	Trigger (input): When a TTL pulse (rising / falling edge) is detected, the camera triggers.

4.6.53 Phantom Miro LAB Series Power Connector (6-Pin Male)

This connector is used to provide the necessary power (+16-28VDC) to the camera.

CONNECTOR	PIN	NOMENCLATURE	FUNCTIONAL DESCRIPTION
	1	PGND	Power Ground
	2	+VINBF	The +VDC In (Battery Freed) connector provides +24VDC (Direct Current) positive power to the Phantom camera.
	3	RXD1	RS-232 Receive Data 1
	4	TXD1	RS-232 Transmit Data 1
	5	Unused	Unused

	6	GND	Ground
--	---	-----	--------

4.6.54 Phantom Miro M / R / LC Series Power Connector (Revision 2) (6-Pin Male)

This connector is used to provide power to the Phantom Miro M- / R- / LC-Series camera models.

CONNECTOR	PIN	NOMENCLATURE	FUNCTIONAL DESCRIPTION
	1	PGND	Power Ground
	2	+VINBF	The +VDC In (Battery Freed) connector provides +24VDC (Direct Current) positive power to the Phantom camera.
	3	RxD 1	RS-232 Receive Data 1
	4	TxD1	RS-232 Transmit Data 1
	5	UNUSED	Not Used
	6	GND	Ground

4.6.55 Phantom Miro Mx40 Power Connector (6-Pin Male)

This connector is used to provide power to the Phantom Miro Mx40 Series camera models.

CONNECTOR	PIN	NOMENCLATURE	FUNCTIONAL DESCRIPTION
	1	PGND	Power Ground
	2	+VINBF	The +VDC In (Battery Freed) connector provides +24VDC (Direct Current) positive power to the Phantom camera.
	3	RxD 1	RS-232 Receive Data 1
	4	TxD1	RS-232 Transmit Data 1
	5	UNUSED	Not Used
	6	GND	Ground

4.6.56 Phantom OFF / AUTO / ON Toggle Switch

Prior to the introduction of the Phantom v1210 and v1610, Phantom cameras did not have a physical power switch. Instead, the camera powered up any time an appropriate DC voltage appeared on the power input to the camera. This was done so that cameras can be powered up (booted) remotely by providing primary power and did not require physical access to the camera.

However, along with the Phantom v1610 and v120 camera models, the Phantom Miro M-series cameras have a physical power switch on them. This switch has three positions:

OFF - When the switch is in the OFF position, the camera is off.

AUTO - When the switch is set to AUTO, it works exactly like any previous Phantom Camera. Providing power to the Primary DC Input will power up (boot) the camera and it will be ready for use.



Even when the switch is set to AUTO, providing battery power to a non-powered camera will not power up the camera.

If there is a loss of primary power, then the battery power will be used to maintain camera operation and protect any stored data (assuming a battery is connected.)

ON - When the switch is moved to the ON position, the camera will power-up immediately provided there is power connected to the primary power port OR a battery is connected to the camera.

4.6.57 Phantom Power Connector (3-Pin Male)

This connector is used to provide the necessary power to the camera.

CONNECTOR	PIN	NOMENCLATURE	FUNCTIONAL DESCRIPTION
	1	VDC	Provides DC (Direct Current) positive power to the Phantom camera. Valid voltage ranges are as follows: +20-36VDC &A Max. (Phantom Flex)
	2	CHGND	Chassis Ground
	3	PGND	Power Ground

4.6.58 Phantom Power Connector (3-Pin Male)

This connector is used to provide the necessary power to the camera.

CONNECTOR	PIN	NOMENCLATURE	FUNCTIONAL DESCRIPTION
	1	VDC	Provides DC (Direct Current) positive power to the Phantom camera. Valid voltage ranges are as follows: +12-28VDC
	2	CHGND	Chassis Ground
	3	PGND	Power Ground

4.6.59 Phantom Power Connector (4-Pin Male)

This connector is used to provide the necessary VDC power to the camera.

CONNECTOR	PIN	NOMENCLATURE	FUNCTIONAL DESCRIPTION
	1	+24VB	The Phantom camera models can connect to a +24VDC battery running parallel to the +24VDC power source.

	2	CHGND	Chassis Ground
	3	PGND	Power Ground
	4	+24VDC	Provide +24VDC (Direct Current) positive power to all Phantom camera models except the Phantom v4.1. This +24VDC runs parallel with an optional +24VDC battery.



The Phantom v4.1 power is supplied via the Phantom v4.1 Power/Capture Connector.

4.6.60 Phantom Programmable I/O

Programmable ports allow the end user to select a signal type from a pull-down selection list, and set the 'pulse processor control' (characteristics) for the signal; see the table below:

CAMERA MODELS	PORT / SIGNAL DEFAL	PROGRAMMABLE / CORE SIG	PULSE PROCESSOR CONTRO
VEO L Series	P1 / Trigger (Fixed)	N/A	Falling / Rising Edge, Filter Time, Delay Time
	P2 / TimeCode In (Fixed)	N/A	
	P3 / F-Sync (Programmable)	Strobe, Frame Sync, Ready, Time Code Out, Multi-Strobe, Auto Trigger, Sw Trigger, Recording, Event In, Memory Gate In, Pretrigger In, Runstop In, Auxtrigger In, Core Event, Core Memory Gate, Core Frame Sync, Core Pretrigger, Core Runstop, Core Auxtrigger, Core Trigger	Invert, Filter, Delay, Width
	P4 (N/A)	N/A	N/A
	P5 / Strobe (Programmable)	Strobe, Frame Sync, Ready, Time Code Out, Multi-Strobe, Auto Trigger, Sw Trigger, Recording, Event In, Memory Gate In, Pretrigger In, Runstop In, Auxtrigger In, Core Event, Core Memory Gate, Core Frame Sync, Core Pretrigger, Core Runstop, Core Auxtrigger, Core Trigger	Invert, Filter, Delay, Width
	P6 (N/A)	N/A	N/A
VEO S Series	P1 / Trigger (Fixed)	N/A	Falling / Rising Edge, Filter

			Time, Delay Time
	P2 / TimeCode In (Fixed)	N/A	
	P3 / Strobe	Strobe, Frame Sync, Ready, Time Code Out, Multi-Strobe, Auto Trigger, Sw Trigger, Recording, Event In. Memory Gate In, Pretrigger In, Runstop In, Auxtrigger In, Core Event, Core Memory Gate, Core Frame Sync, Core Pretrigger, Core Runstop, Core Auxtrigger, Core Trigger	Invert, Filter, Delay, Width
	P4 / F-Sync		
	P5 / Ready		
	P6 / TimeCode Out		
Phantom UHS v2640	P1 / Trigger (Fixed)	N/A	Falling / Rising Edge, Filter Time, Delay Time
	P2 / TimeCode In (Fixed)	N/A	
	P3 / F-Sync	Strobe, Frame Sync, Ready, Time Code Out, Multi-Strobe, Auto Trigger, Sw Trigger, Recording, Event In. Memory Gate In, Pretrigger In, Runstop In, Auxtrigger In, Core Event, Core Memory Gate, Core Frame Sync, Core Pretrigger, Core Runstop, Core Auxtrigger, Core Trigger	Invert, Filter, Delay, Width
	P4 / Strobe		
	P5 / Ready		
	P6 / TimeCode Out		

Programmable Signals and Descriptions



All descriptions are the signal's default state prior to processing.

Ready: An isolated open collector output with 1k pull-up signal (active high). Ready is asserted when the camera goes into capture mode and is de-asserted either when the Cine is triggered, or when the Cine recording is completed. Ready changes synchronously with frame capture (at the end of each exposure), so in external sync mode it will not change until F-Sync pulses are received.

Strobe: An isolated open collector output signal, with 1k pull-up. When asserted (low) Strobe indicates that the camera integrates (the electronic shutter is open).

F-Sync: Is the only signal can be set as an output or input. By default it is output (sync-internal). Output signal is a frame sync pulse from the camera's frame rate generator. A short (few hundred ns depending in camera model) negative pulse, with the falling edge used as timing reference. Input signal is active on falling edge (default state is high).

TC Out: A positive polarity time code signal. Normally an unmodulated (dc-shifted) IRIG-B (at RS-232 levels), which follows the internal time base of the camera. It is recommended not to process the TC-Out, since a processed signal may no longer represent a standard or accurate time code.

Auto Trigger: Used to output a hardware trigger signal or pulse with the duration.

Software Trigger: An active high-output signal (pulse) generated as a result of the trigger protocol command.

Recording: An active high-output signal. When active, indicates the camera is recording into a RAM partition.

Event In: If the input is sampled low at the end of an exposure, an 'E' (Event) bit in the frame's time stamp is set.

Memory Gate In: If the input is sampled low at the end of an exposure, the corresponding frame is skipped from storage to RAM.

Pre-Trigger: An active low input (default high) signal. Keeping this signal low for enough time (10 - 500ms, or until 'Ready' signal goes high) will make the camera start recording if it has an available RAM partition.

Aux Trigger: An input signal active on the rising edge (default high). This is an alternative trigger input that can be processed through the programmable port pulse processors and assigned to different ports.n). Strobe is low for the duration of the exposure.

Programmable Signals and Description: The Core Signals

Core signals are copies of externally generated signals, routed through the camera and output to assigned ports. Core signals can be pulse-processed before being output. The current list of signals is:

Core Event: Feedback output from the Event In signal. The feedback is taken after any pulse processor for the output.

Core Memory Gate: Feedback output from the Memory Gate In signal. The feedback is taken after any pulse processor for the output.

Core Frame Sync: Feedback output from the F-Sync In signal. The feedback is taken after any pulse processor for the output, but before the delay element.

Core Pretrigger: Feedback output from the Pre-Trigger signal. The feedback is taken after any pulse processor for the input.

Core Auxtrigger: Feedback output from the Aux Trigger In signal. The feedback is taken after any pulse processor for the input.

Core Trigger: Feedback output from the main Trigger input. The feedback is taken before the trigger signal is affected by the trigger polarity, filter or delay settings. 'Core Trigger' can be used like a 'Trigger Out' signal.

4.6.61 Phantom Range Data Connector (6-Pin Male)

Primarily intended for acquisition of altitude/azimuth/range information from tracking mounts, the range data input does not impose any formatting on the actual data recorded; as such, it can be used to record arbitrary digital data. The range data interface consists of 3 differential pairs. The differential pairs use RS-422 signaling levels, and are intended to be used in point-to-point connections. Maximum data per frame is 128-bytes.

CONNECTOR	PIN	NOMENCLATURE	FUNCTIONAL DESCRIPTION
	A	CHGND	Chassis Ground
	B	Serial Data In+	Serial Data In (positive)
	C	Serial Data In-	Serial Data In (negative)
	D	Corp+	Correlation Pulse Output (positive)

	E	Corp-	Correlation Pulse Output (negative)
	F	GND	Signal Ground

4.6.62 Phantom Range Data Connector (8-Pin Male)

Primarily intended for acquisition of altitude/azimuth/range information from tracking mounts, the range data input does not impose any formatting on the actual data recorded; as such, it can be used to record arbitrary digital data. The range data interface consists of 2 differential pairs. The differential pairs use RS-422 signaling levels, and are intended to be used in point-to-point connections.

CONNECTOR	PIN	NOMENCLATURE	FUNCTIONAL DESCRIPTION
	1	GND	Ground
	2	ROUT+	Remote/Range Data Out (Positive), (RS-422); +5V maximum. Depending on data transmission rates, RS-422 can be used at distances to 4,000 feet (1,275 meters).
	3	ROUT-	Remote/Range Data Out (Negative), (RS-422); +5V maximum. Depending on data transmission rates, RS-422 can be used at distances to 4,000 feet (1,275 meters).
	4	RIN+	Remote/Range Data In (Positive), (RS-422); +5V maximum. Depending on data transmission rates, RS-422 can be used at distances to 4,000 feet (1,275 meters).
	5	RIN-	Remote/Range Data In (Negative), (RS-422); +5V maximum. Depending on data transmission rates, RS-422 can be used at distances to 4,000 feet (1,275 meters).
	6	+3V3R	
	7	+24VR	
	8	GND	Ground

4.6.63 Phantom RCU Battery Compartment

The Battery Compartment contains a BP-511 battery, providing up to 2 hours of battery operation, and doubles as the hand grip for the Remote Control Unit.

4.6.64 Phantom RCU Optional Bluetooth

The Optional Industrial Bluetooth provides wireless control of a user specified camera.

4.6.65 Phantom RCU HD-SDI Video-In Connector (BNC)

CONNECTOR	PIN	NOMENCLATURE	FUNCTIONAL DESCRIPTION
 HD-SDI Video-In		SDI-IN	The serial digital interface coaxial cable with BNC connector has a nominal impedance of 75 ohms. This is the same type of cable used in analog video setups, which potentially makes for easier upgrades (though higher quality cables may be necessary for long runs at the higher bit rates). The specified signal amplitude at the source is 800 mV ($\pm 10\%$) peak-to-peak for lower voltages may be measured at the receiver owing to attenuation. Using equalization at the receiver, it is possible to send 270 Mbit/s SDI over 300 meters without the use of repeaters, but shorter lengths are preferred. The HD bit rates have a shorter maximum run length, typically 100 meters.

4.6.66 Phantom RCU Power, Control, Analog Video Connector

CONNECTOR	PIN	NOMENCLATURE	FUNCTIONAL DESCRIPTION
 <p>Power, Control, Analog Video</p>	1	VCC	+24VDC - The Remote Control Unit uses DC, (Direct Current), power. The nominal power supply voltage is +24VDC. The acceptable power supply range is +12VDC to +36VDC. Power supply inputs are protected against polarity reversal, (with a shunt diode fused by a 1.25A PTC reset able fuse). The Remote Control Unit is also protected to under voltage and will shut down when the DC input is below circa 17VDC. The power supply input terminals are isolated from the case and system ground. This is usually achieved by using a properly isolated power supply.
	2	GND	Ground
	3	AVGND	Analog Video Ground
	4	AVIN	Analog Video In - The analog video input of the Remote Control Unit is a standard level, 75-ohm input. It is not isolated. The video input is properly terminated, (75-ohm), to drive the analog, (NTSC or PAL) video output from the attached Phantom camera properly.
	5	TX1	RS-232 Transmit Data
	6	RX1	RS-232 Receive Data
	7	GND	Ground
	8	TX2	RS-232 Transmit Data - For Engineering Use Only
	9	RX2	RS-232 Receive Data - For Engineering Use Only

4.6.67 Phantom RCU Type A USB Receptacle

CONNECTOR	PIN	NOMENCLATURE	FUNCTIONAL DESCRIPTION
 <p>Type A USB Receptacle</p>	1	GND	Ground
	2	ROUT+	Remote/Range Data Out (Positive), (RS-422); +5V maximum. Depending on data transmission rates, RS-422 can be used at distances to 4,000 feet (1,275 meters).
	3	ROUT-	Remote/Range Data Out (Negative), (RS-422); +5V maximum. Depending on data transmission rates, RS-422 can be used at distances to 4,000 feet (1,275 meters).

			meters).
4	RIN+	Remote/Range Data In (Positive), (RS-422); +5V maximum. Depending on data transmission rates, RS-422 can be used at distances to 4,000 feet (1,275 meters).	
5	RIN-	Remote/Range Data In (Negative), (RS-422); +5V maximum. Depending on data transmission rates, RS-422 can be used at distances to 4,000 feet (1,275 meters).	
6	+3V3R		
7	+24VR		
8	GND	Ground	

4.6.68 Phantom Remote/Range Data Connector (8-Pin Female)

Primarily intended for acquisition of altitude/azimuth/range information from tracking mounts, the range data input does not impose any formatting on the actual data recorded; as such, it can be used to record arbitrary digital data. The range data interface consists of 2 differential pairs. The differential pairs use RS-422 signaling levels, and are intended to be used in point-to-point connections.

CONNECTOR	PIN	NOMENCLATURE	FUNCTIONAL DESCRIPTION
	1	GND	Ground
	2	ROUT+	Remote/Range Data Out (Positive), (RS-422); +5V maximum. Depending on data transmission rates, RS-422 can be used at distances to 4,000 feet (1,275 meters).
	3	ROUT-	Remote/Range Data Out (Negative), (RS-422); +5V maximum. Depending on data transmission rates, RS-422 can be used at distances to 4,000 feet (1,275 meters).
	4	RIN+	Remote/Range Data In (Positive), (RS-422); +5V maximum. Depending on data transmission rates, RS-422 can be used at distances to 4,000 feet (1,275 meters).
	5	RIN-	Remote/Range Data In (Negative), (RS-422); +5V maximum. Depending on data transmission rates, RS-422 can be used at distances to 4,000 feet (1,275 meters).
	6	+3V3R	
	7	+24VR	

	8	GND	Ground
--	---	-----	--------

4.6.69 Phantom Remote Connector (5-Pin Female)

CONNECTOR	PIN	NOMENCLATURE	FUNCTIONAL DESCRIPTION
	1	+24VDC	
	2	PNG	The power input and the acquisition control signals are isolated from the camera system ground. This isolation is designed to avoid system ground loops only, and should not be subject to high voltages.
	3	XRXD	Receive Data (RS-232); +5V maximum, normally limited to 50 feet (16 meters).
	4	XTXD	Transmit Data (RS-232); +5V maximum, normally limited to 50 feet (16 meters).
	5	IOGND2	RS232 Ground - All the serial ports are not isolated (referred to system ground). As such, they should only be connected to properly earthed equipment.

4.6.70 Phantom Return / Genlock (3G HD-SDI)

CONNECTOR	PIN	NOMENCLATURE	FUNCTIONAL DESCRIPTION
 Return / Genlock (3G HD-SDI)		SDIOUT	<p>SDI (Serial Digital Interface) - single-link coaxial cable with a nominal impedance of 75-ohm. The specified signal amplitude at the source is 800 mV ($\pm 10\%$) peak-to-peak (lower voltages may be measured at the receiver owing to attenuation).</p> <p>Allows for bit-rates of 2.970 Gbit/s and 2.970/1.001 Gbit/s (1080p video at 50 or 60 fps), reliable (without use of repeaters) at cable lengths of 100 m (330') using RG6 cable, 60 m (200') using RG59 cable.</p> <p>Genlock - used to synchronize the playback to a video signal, utilizing a composite video inbound signal. This video input signal should be a properly terminated, (75-ohm), and the signal must not exceed +1.56V maximum. For anything but the shortest cable runs, quality 75-ohm coax, (e.g. RG59/U), must be used.</p> <p>It will also synch live video, by synchronizing the SDI outputs to the GenLock signal.</p>

4.6.71 Phantom R/S (Run / Stop) Connector

CONNECTOR	PIN	NOMENCLATURE	FUNCTIONAL DESCRIPTION
	1	GND	Chassis Ground
	2	+VSAUX	+24V
	3	TRIGGER	Isolated input; Active low. Can be activated by a switch to ground. The trigger is edge-sensitive, and the exact time of the trigger edge is recorded. The trigger pulse needs to be at least 3μs long.

4.6.72 Phantom RTO Fiber Optic Connector

Used to transmit streaming data out to an external storage device such as the Image³. This connector is incorporated on the Phantom v10, v9.1, v9.0, v7.3, and v5.2 camera models only.

4.6.73 Phantom Sync (Capture) Connector

CONNECTOR	PIN	NOMENCLATURE	FUNCTIONAL DESCRIPTION
	1	IOGND1	RS232 Ground - All the serial ports are not isolated (referred to system ground). As such, they should only be connected to properly earthed equipment.
	2	IOGND1	See Pin 1
	3	IOGND1	See Pin 1
	4	TRIGGER	Isolated input; Active low. Can be activated by a switch to ground. The trigger is edge-sensitive, and the exact time of the trigger edge is recorded. The trigger pulse needs to be at least 3μs long.
	5	AUX	<p>Isolated open collector output, with 1k pull-up. When asserted (low) Strobe indicates that the camera integrates (the shutter is open). Strobe is low for the duration of the exposure.</p> <p>Event is an active-low isolated input whose state is recorded at the end of each exposure. The signal must be active when the strobe goes high, and be at least 30μs long to guarantee it is properly recorded.</p> <p>MemGate is an active-low isolated input. When asserted, the current frame is discarded instead of being written into the memory. The decision is taken at the end of the exposure (after STROBE goes high). MemGate needs to be low the moment STROBE goes high and stays low for at least 15μs to disable recording of the current frame.</p>

	6	FSYNC	Bi-directional isolated signal.
	7	TCIN	Some Phantom cameras provide unmodulated IRIG-B time code inputs. The input withstands signals of up to +/- 15v. The input threshold is 1.5V, so the input is also compatible with TTL levels. This connector can also be used to receive the SMPTE (Society of Motion Picture and Television Engineers) Time Code.
	8	IOGND1	See Pin 1
	9	EBUIN	EBU (European Broadcasting Union) Digital Audio Input
	10	UNUSED	Not used
	11	UNUSED	Not used
	12	TCOUT	Some Phantom cameras provide unmodulated IRIG B time code inputs and outputs. The output swings to RS-232 levels of +/-9V. This connector can also be used to output the SMPTE Time Code.

4.6.74 Phantom Trigger Connector (BNC)

CONNECTOR	PIN	NOMENCLATURE	FUNCTIONAL DESCRIPTION
<p>Trigger-In</p>		Trigger-In	Isolated input. Active low. It can be activated by a switch to ground. On early cameras the trigger was level-sensitive, and was accepted if asserted (low) at the end of an exposure. As such, the trigger signal should have lasted at least as much as the reciprocal of the frame rate to guarantee it was recognized. Now the trigger is edge-sensitive, and the exact time of the trigger edge is recorded. The trigger pulse needs to be at least 3μs long.

4.6.75 Phantom Timecode Connectors (BNC)

CONNECTOR	PIN	NOMENCLATURE	FUNCTIONAL DESCRIPTION
<p>1. TimeCode In 2. TimeCode Out</p>	1	IRIG-In / SMPTE-In	Some Phantom cameras provide unmodulated IRIG B time code inputs. The input withstands signals of up to +/- 15v. The input threshold is 1.5V, so the input is also compatible with TTL levels. This connector can also be used to receive the SMPTE (Society of Motion Picture and Television Engineers) Time Code.
	2	IRIG-Out / SMPTE-Out	Some Phantom cameras provide unmodulated IRIG B

			time code inputs and outputs. The output swings to RS-232 levels of +/-9V. This connector can also be used to output the SMPTE Time Code.
--	--	--	--

4.6.76 Phantom Component Viewfinder

This connector provides a means to connect the controlling laptop or PC to your Phantom camera. The Ethernet connector provides connectivity to other cameras in a multi-camera setup.

CONNECTOR	PIN	NOMENCLATURE	FUNCTIONAL DESCRIPTION
	1	GND	Viewfinder Power Ground
	2	GND	Viewfinder power ground
	3	PB	High-Definition Blue
	4	PR	High-Definition Red
	5	Y	High-Definition Green
	6	GND	Viewfinder power ground
	7	+12 V	Positive 12VDC / 1.5 Amp

4.6.77 Phantom VEO Capture Connector (12-Pin Male)

CONNECTOR	PIN	NOMENCLATURE	FUNCTIONAL DESCRIPTION
	1	IOGND	Signal Ground
	2	IOGND	Signal Ground
	3	IOGND	Signal Ground
	4	TRIGGER	Isolated Input. Active low. Can be activated by a switch to ground. Pulse must be at least 3 microseconds long.
	5	P/IO 5	(Programmable I/O) default signal is READY
	6	P/IO 3	(Programmable I/O) default signal is STROBE
	7	TCIN	Timecode Input can accept IRIG-B and SMPTE standards.
	8	GND	Reference Pin 9
	9	P/IO 4	(Programmable I/O) default signal is F-SYNC
	10	POWER	Nominal power supply voltage is +24VDC (acceptable

			range is 16-36VDC.
	11	POWER	Reference Pin 10
	12	P/IO 6	(Programmable I/O) default signal is TIMECODE OUT

4.6.78 Phantom VEO Power Connector (6-Pin Male)

This connector is used to provide the necessary power to the camera.

CONNECTOR	PIN	NOMENCLATURE	FUNCTIONAL DESCRIPTION
	1	PGND	Power Ground
	2	VDC	Provides DC (Direct Current) positive power to the Phantom camera. Valid voltage ranges are +16-28VDC
	3	RxD1	RS-232 Receive Data 1
	4	TxD1	RS-232 Transmit Data 1
	5	UNUSED	Not used
	6	GND	Ground

4.6.79 Phantom ViewFinder (3G HD-SDI)

CONNECTOR	PIN	NOMENCLATURE	FUNCTIONAL DESCRIPTION
 3G HD-SDI		SDIOUT	<p>SDI (Serial Digital Interface) - single-link coaxial cable with a nominal impedance of 75-ohm. The specified signal amplitude at the source is 800 mV ($\pm 10\%$) peak-to-peak (lower voltages may be measured at the receiver owing to attenuation).</p> <p>Allows for bit-rates of 2.970 Gbit/s and 2.970/1.001 Gbit/s (1080p video at 50 or 60 fps), reliable (without use of repeaters) at cable lengths of 100 m (330') using RG6 cable, 60 m (200') using RG59 cable.</p>

4.6.80 Phantom ViewFinder Connector (Revision 2) (7-Pin Female)

This Viewfinder connector is not available on Phantom camera models.

CONNECTOR	PIN	NOMENCLATURE	FUNCTIONAL DESCRIPTION
	1	PGND	ViewFinder Power Ground
	2	PGND	ViewFinder Power Ground
	3	PB	HD Blue
	4	PR	HD Red
	5	Y	HDGreen
	6	VGND	ViewFinder Ground
	7	+12V Out	Positive 12VDC 1.5Amp

4.6.81 Phantom ViewFinder Connector (Revision 1) (7-Pin Female)

This Viewfinder connector is not available on Phantom camera models.

CONNECTOR	PIN	NOMENCLATURE	FUNCTIONAL DESCRIPTION
	1	VOUT	<p>The video output of the Phantom cameras is a standard level, 75-ohm output. It is not isolated. The video output should only drive a properly terminated (75-ohm) input. Also, for anything but the shortest cable runs, quality 75-ohm coax (e.g. RG59/U) must be used.</p>
	2	VGND	<p>Composite Video Ground/Shield</p>
	3	SDIOUT2	<p>SDI (Serial Digital Interface) Out</p> <p>The HD-SDI (High-Definition-Serial Digital Interface) connector is only available on the Phantom v10, v9.1, and v7.3 camera models.</p>

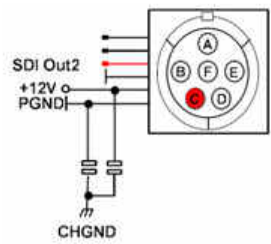
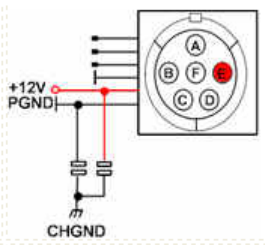
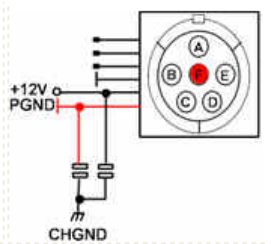
			<p>The serial digital interface coaxial cable with BNC connector has a nominal impedance of 75 ohms. This is the same type of cable used in analog video setups, which potentially makes for easier upgrades (though higher quality cables may be necessary for long runs at the higher bit rates). The specified signal amplitude at the source is 800 mV ($\pm 10\%$) peak-to-peak for lower voltages may be measured at the receiver owing to attenuation. Using equalization at the receiver, it is possible to send 270 Mbit/s SDI over 300 meters without the use of repeaters, but shorter lengths are preferred. The HD bit rates have a shorter maximum run length, typically 100 meters.</p> 
4	SDIGND	SDI Ground	
5	+12VOut	Positive 12VDC 1.5Amp	
6	PGND	ViewFinder Power Ground	

4.6.82 Phantom ViewFinder Power Connector

This Viewfinder connector is not available on Phantom camera models.

CONNECTOR	PIN	NOMENCLATURE	FUNCTIONAL DESCRIPTION
	1	GND	Chassis Ground
	2	RTALLY	
	3	GTALLY	
	4	+VFINDER	Positive 12VDC / 1.5 Amp

4.7 Indicators

4.7.1 Current Cameras

Vision Research categorizes Phantom cameras as Current for cameras that are presently being manufactured or sold. These products receive full support from Vision Research, including, all development and new features. Service contracts are available for these products.

4.7.1.1 Phantom Flex Series

The current Phantom Flex Series cameras include: Phantom Flex4K, Flex4K-GS, and Flex.

4.7.1.1.1 Phantom Flex4K, Flex4K-GS

The LED indicators below provide you with a visual representation of the camera's operational state, and communication status.

Capture Indicator

The Capture LED provides a visual indication of the cameras operational states. By factory default, the camera is placed into the Preview - Waiting for Pre-trigger mode when the camera is powered on, unless it has otherwise been user-configured to start in the Recording waiting for trigger (capture) mode. Once in the Capture mode the camera starts recording images into the cameras circular memory buffer (RAM). Upon detection of a trigger signal, the camera is instructed to stop writing to the cameras internal memory buffer, once the number of specified Post Trigger frames has been reached, and the camera will be placed into the Preview mode. If the camera has been configured to automatically save the images to Flash the camera will, at this point write the images stored in the cameras RAM to the Flash module.

User intervention is required to either save the Cine to an external drive, or to put the camera back into the capture mode from the Setup and Recording screen.

The following will indicate the camera's operational state described above:

- Off Preview or Preview - Waiting for Trigger
- On Recording waiting for trigger (capture)

Ethernet Activity Indicator

When active the LED indicates data is being transferred between the camera and the Phantom Control Unit computer.

Ethernet Link Indicator

When active the LED indicates that the camera is detected and is connected to an Ethernet network.

4.7.1.1.2 Phantom Flex

The LED indicators below provide you with a visual representation of the camera's operational state, and communication status.

Power Indicator

The Power LED provides a visual indication of camera power status and firmware integrity. If power is being supplied to the camera, and this LED is not lit, it indicates an error has occurred in the camera firmware. If this happens it is best to reboot the camera to correct the error.

Capture Indicator

The Capture LED provides a visual indication of the cameras operational states. By factory default, the camera is placed into the Preview - Waiting for Pre-trigger mode when the camera is powered on, unless it has otherwise been user-configured to start in the Recording waiting for trigger (capture) mode. Once in the Capture mode the camera starts recording images into the cameras circular memory buffer (RAM). Upon detection of a trigger signal, the camera is instructed to stop writing to the cameras internal memory buffer, once the number of specified Post Trigger frames has been reached, and the camera will be placed into the Preview mode. If the camera has been configured to automatically save the images to Flash the camera will, at this point write the images stored in the cameras RAM to the Flash module.

User intervention is required to either save the Cine to an external drive, or to put the camera back into the capture mode from the Setup and Recording screen.

The following will indicate the camera's operational state described above:

- Off Preview or Preview - Waiting for Trigger
- On Recording waiting for trigger (capture)

Ethernet Activity Indicator

When active the LED indicates data is being transferred between the camera and the Phantom Control Unit computer.

Ethernet Link Indicator

When active the LED indicates that the camera is detected and is connected to an Ethernet network.

GenLock Indicator

When active the LED indicates that an inbound composite video signal is being used to synchronize the playback to a video signal, or the synchronization of live video by synchronizing the SDI outputs to the GenLock signal.

4.7.1.2 Phantom UHS Series

Enter topic text here.

4.7.1.2.1 Phantom UHS v2640

The current Phantom UHS (Ultra-high Speed) Series cameras include: Phantom v2512, v2012, v1612, and v1212. The LED indicators below provide you with a visual representation of the camera's operational state, and communication status.

Power Indicator

The Power LED provides a visual indication of camera power status and firmware integrity. If power is being supplied to the camera, and this LED is not lit, it indicates an error has occurred in the camera firmware. If this happens it is best to reboot the camera to correct the error.

Capture Indicator

The Capture LED provides a visual indication of the cameras operational states. By factory default, the camera is placed into the Preview - Waiting for Pre-trigger mode when the camera is powered on, unless it has otherwise been user-configured to start in the Recording waiting for trigger (capture) mode. Once in the Capture mode the camera starts recording images into the cameras circular memory buffer (RAM). Upon detection of a trigger signal, the camera is instructed to stop writing to the cameras internal memory buffer, once the number of specified Post Trigger frames has been reached, and the camera will be placed into the Preview mode. If the camera has been configured to automatically save the images to Flash the camera will, at this point write the images stored in the cameras RAM to the Flash module.

User intervention is required to either save the Cine to an external drive, or to put the camera back into the capture mode from the Setup and Recording screen.

The following will indicate the camera's operational state described above:

- Off Preview or Preview - Waiting for Trigger
- On Recording waiting for trigger (capture)

Ethernet Activity Indicator

When active the LED indicates data is being transferred between the camera and the Phantom Control Unit computer.

Ethernet Link Indicator

When active the LED indicates that the camera is detected and is connected to an Ethernet network.

GenLock Indicator

When active the LED indicates that an inbound composite video signal is being used to synchronize the playback to a video signal, or the synchronization of live video by synchronizing the SDI outputs to the GenLock signal.

4.7.1.2.2 Phantom UHS xx12 Series

The current Phantom UHS (Ultra-high Speed) Series cameras include: Phantom v2512, v2012, v1612, and v1212. The LED indicators below provide you with a visual representation of the camera's operational state, and communication status.

Power Indicator

The Power LED provides a visual indication of camera power status and firmware integrity. If power is being supplied to the camera, and this LED is not lit, it indicates an error has occurred in the camera firmware. If this happens it is best to reboot the camera to correct the error.

Capture Indicator

The Capture LED provides a visual indication of the cameras operational states. By factory default, the camera is placed into the Preview - Waiting for Pre-trigger mode when the camera is powered on, unless it has otherwise been user-configured to start in the Recording waiting for trigger (capture) mode. Once in the Capture mode the camera starts recording images into the cameras circular memory buffer (RAM). Upon detection of a trigger signal, the camera is instructed to stop writing to the cameras internal memory buffer, once the number of specified Post Trigger frames has been reached, and the camera will be placed into the Preview mode. If the camera has been configured to automatically save the images to Flash the camera will, at this point write the images stored in the cameras RAM to the Flash module.

User intervention is required to either save the Cine to an external drive, or to put the camera back into the capture mode from the Setup and Recording screen.

The following will indicate the camera's operational state described above:

- Off Preview or Preview - Waiting for Trigger
- On Recording waiting for trigger (capture)

Ethernet Activity Indicator

When active the LED indicates data is being transferred between the camera and the Phantom Control Unit computer.

Ethernet Link Indicator

When active the LED indicates that the camera is detected and is connected to an Ethernet network.

GenLock Indicator

When active the LED indicates that an inbound composite video signal is being used to synchronize the playback to a video signal, or the synchronization of live video by synchronizing the SDI outputs to the GenLock signal.

4.7.1.2.3 Phantom UHS xx11 Series

The current Phantom UHS (Ultra-high Speed) Series cameras include: Phantom v2511, v2011, v1611, and v1211. The LED indicators below provide you with a visual representation of the camera's operational state, and communication status.

Power Indicator

The Power LED provides a visual indication of camera power status and firmware integrity. If power is being supplied to the camera, and this LED is not lit, it indicates an error has occurred in the camera firmware. If this happens it is best to reboot the camera to correct the error.

Capture Indicator

The Capture LED provides a visual indication of the cameras operational states. By factory default, the camera is placed into the Preview - Waiting for Pre-trigger mode when the camera is powered on, unless it has otherwise been user-configured to start in the Recording waiting for trigger (capture) mode. Once in the Capture mode the camera starts recording images into the cameras circular memory buffer (RAM). Upon detection of a trigger signal, the camera is instructed to stop writing to the cameras internal memory buffer, once the number of specified Post Trigger frames has been reached, and the camera will be placed into the Preview mode. If the camera has been configured to automatically save the images to Flash the camera will, at this point write the images stored in the cameras RAM to the Flash module.

User intervention is required to either save the Cine to an external drive, or to put the camera back into the capture mode from the Setup and Recording screen.

The following will indicate the camera's operational state described above:

- Off Preview or Preview - Waiting for Trigger
- On Recording waiting for trigger (capture)

Ethernet Activity Indicator

When active the LED indicates data is being transferred between the camera and the Phantom Control Unit computer.

Ethernet Link Indicator

When active the LED indicates that the camera is detected and is connected to an Ethernet network.

GenLock Indicator

When active the LED indicates that an inbound composite video signal is being used to synchronize the playback to a video signal, or the synchronization of live video by synchronizing the SDI outputs to the GenLock signal.

4.7.1.3 Phantom v-Series

The current Phantom v-Series cameras include: Phantom v642 Broadcast, v711, v641, v611, v411, and v341. The LED indicators below provide you with a visual representation of the camera's operational state, and communication status.

Power Indicator

The Power LED provides a visual indication of camera power status and firmware integrity. If power is being supplied to the camera, and this LED is not lit, it indicates an error has occurred in the camera firmware. If this happens it is best to reboot the camera to correct the error.

Capture Indicator

The Capture LED provides a visual indication of the cameras operational states. By factory default, the camera is placed into the Preview - Waiting for Pre-trigger mode when the camera is powered on, unless it has otherwise been user-configured to start in the Recording waiting for trigger (capture) mode. Once in the Capture mode the camera starts recording images into the cameras circular memory buffer (RAM). Upon detection of a trigger signal, the camera is instructed to stop writing to the cameras internal memory buffer, once the number of specified Post Trigger frames has been reached, and the camera will be placed into the Preview mode. If the camera has been configured to automatically save the images to Flash the camera will, at this point write the images stored in the cameras RAM to the Flash module.

User intervention is required to either save the Cine to an external drive, or to put the camera back into the capture mode from the Setup and Recording screen.

The following will indicate the camera's operational state described above:

- Off Preview or Preview - Waiting for Trigger
- On Recording waiting for trigger (capture)

Ethernet Activity Indicator

When active the LED indicates data is being transferred between the camera and the Phantom Control Unit computer.

Ethernet Link Indicator

When active the LED indicates that the camera is detected and is connected to an Ethernet network.

GenLock Indicator

When active the LED indicates that an inbound composite video signal is being used to synchronize the playback to a video signal, or the synchronization of live video by synchronizing the SDI outputs to the GenLock signal.

4.7.1.4 Phantom Miro C Series

The current Phantom Miro C Series cameras include: Miro C210 and C210J.

4.7.1.4.1 Phantom Miro C110

The LED indicators below provide you with a visual representation of the camera's operational state, and communication

status.

Trigger LED

- Off - Camera Preview Mode
- Red - Active / Capturing waiting for trigger
- Red - Blinking / Capturing post trigger frames

Ethernet LED

- Green - Ethernet Link
- Amber - Ethernet Activity

4.7.1.4.2 Phantom Miro C210

The LED indicators below provide you with a visual representation of the camera's operational state, and communication status.

System / Status LED

- White - Camera Booting
- Green - Preview Mode
- Red - Capture Mode

Ethernet LED

- Green - EtherLink
- Amber - Ethernet Activity

Battery LED

- Off - Battery fully charged, but not armed
- Green - Battery armed
- Blue - Battery charging or DC power removed
- Red - Battery charging fault
- Cyan - Battery armed and charging or DC power removed
- Purple - Battery charging or DC power removed and charging Fault
- Amber - Battery armed and charging fault
- White - Battery armed, charging or DC power removed, and charging fault

4.7.1.4.3 Phantom Miro C210J

The LED indicators below provide you with a visual representation of the camera's operational state, and communication status.

System / Status LED

- White - Camera Booting
- Green - Preview Mode
- Red - Capture Mode

Ethernet LED

Green - EtherLink

Amber - Ethernet Activity

Battery LED

Off - Battery fully charged, but not armed

Green - Battery armed

Blue - Battery charging or DC power removed

Red - Battery charging fault

Cyan - Battery armed and charging or DC power removed

Purple - Battery charging or DC power removed and charging Fault

Amber - Battery armed and charging fault

White - Battery armed, charging or DC power removed, and charging fault

4.7.1.4.4 Phantom Miro N5 and N-JB (Junction Box)

The LED indicators below provide you with a visual representation of the camera's operational state, and communication status.

Miro N5 System / Status LED

White - Camera Booting

Green - Preview Mode

Red - Capture Mode

4.7.1.5 Phantom Miro LAB Series

The current Phantom Miro LAB Series cameras include the Miro LAB110, LAB310, LAB3a10, LAB120, LAB320, LAB140, and LAB340. The LED indicators below provide you with a visual representation of the camera's operational state, and communication status.

Power Indicator

The Power LED provides a visual indication of camera power status and firmware integrity. If power is being supplied to the camera, and this LED is not lit, it indicates an error has occurred in the camera firmware. If this happens it is best to reboot the camera to correct the error.

Capture Indicator

The Capture LED provides a visual indication of the cameras operational states. By factory default, the camera is placed into the Preview - Waiting for Pre-trigger mode when the camera is powered on, unless it has otherwise been user-configured to start in the Recording waiting for trigger (capture) mode. Once in the Capture mode the camera starts recording images into the cameras circular memory buffer (RAM). Upon detection of a trigger signal, the camera is instructed to stop writing to the cameras internal memory buffer, once the number of specified Post Trigger frames has been reached, and the camera will be placed into the Preview mode. If the camera has been configured to automatically save the images to Flash the camera will, at this point write the images stored in the cameras RAM to the Flash module.

User intervention is required to either save the Cine to an external drive, or to put the camera back into the capture mode from the Setup and Recording screen.

The following will indicate the camera's operational state described above:

Off Preview or Preview - Waiting for Trigger

On Recording waiting for trigger (capture)

Ethernet Activity Indicator

When active the LED indicates data is being transferred between the camera and the Phantom Control Unit computer.

Ethernet Link Indicator

When active the LED indicates that the camera is detected and is connected to an Ethernet network.

Phantom CineFlash Recording Indicator

The Phantom CineFlash Recording Indicator will be active (red) when a Cine is being saved to the CineFlash. Do not remove the CineFlash during this process.

4.7.1.6 Phantom VEO Series

The current Phantom VEO camera models include: VEO-S , VEO4K-S, VEO-L, VEO4K-L, and VEO4K-PL Series.

4.7.1.6.1 Phantom VEO L Series

The current Phantom VEO L Series cameras include: VEO 710L, VEO 410L, VEO 640L, VEO 340L, VEO4K 590L, and VEO4K 990L. The LED indicators below provide you with a visual representation of the camera's operational state, and communication status.

Capture Indicator

Green - indicates Cine Stored or camera is in Live Preview mode

Red - indicates camera is Capture mode

Ethernet Indicator (Flashes)

Yellow - indicates data is being transferred between the camera and the Phantom Control Unit computer.

Green - indicates that the camera is detected and is connected to an Ethernet network.

On-Camera Control Buttons - illuminate when in Playback mode as follows:

Tools - reverse arrow

B-REF- forward arrow

Playback - up / down arrows

Trigger - red when camera is in capture mode)

4.7.1.6.2 Phantom VEO S Series

The current Phantom VEO S Series cameras include: VEO 710S, VEO 410S, VEO 640S, VEO 340S, VEO 590S, VEO 990S. The VEO4K-PL Series utilizes the same indicators as the VEO S Series cameras. The LED indicators below provide you with a visual representation of the camera's operational state, and communication status.

Capture Indicator

Green - indicates Cine Stored or camera is in Live Preview mode

Red - indicates camera is Capture mode

Ethernet Indicator (Flashes)

Yellow - indicates data is being transferred between the camera and the Phantom Control Unit computer.

Green - indicates that the camera is detected and is connected to an Ethernet network.

CFast Indicator

Active during save process.

On-Camera Control Buttons - illuminate when in Playback mode as follows:

Tools - reverse arrow

B-REF- forward arrow

Playback - up / down arrows

Trigger - red when camera is in capture mode)

4.7.1.7 Phantom Miro M / R / LC Series

The current Phantom Miro M / R / LC Series cameras include: Miro M340, M320S, M310, M140, M120, M110, R320S, R310, R120, R110, LC320S, LC310, LC120, LC110. The LED indicators below provide you with a visual representation of the camera's operational state, and communication status.

Power Indicator

The Power LED provides a visual indication of camera power status and firmware integrity. If power is being supplied to the camera, and this LED is not lit, it indicates an error has occurred in the camera firmware. If this happens it is best to reboot the camera to correct the error.

Capture Indicator

The Capture LED provides a visual indication of the cameras operational states. By factory default, the camera is placed into the Preview - Waiting for Pre-trigger mode when the camera is powered on, unless it has otherwise been user-configured to start in the Recording waiting for trigger (capture) mode. Once in the Capture mode the camera starts recording images into the cameras circular memory buffer (RAM). Upon detection of a trigger signal, the camera is instructed to stop writing to the cameras internal memory buffer, once the number of specified Post Trigger frames has been reached, and the camera will be placed into the Preview mode. If the camera has been configured to automatically save the images to Flash the camera will, at this point write the images stored in the cameras RAM to the Flash module.

User intervention is required to either save the Cine to an external drive, or to put the camera back into the capture mode from the Setup and Recording screen.

The following will indicate the camera's operational state described above:

Off Preview or Preview - Waiting for Trigger

On Recording waiting for trigger (capture)

Ethernet Activity Indicator

When active the LED indicates data is being transferred between the camera and the Phantom Control Unit computer.

Ethernet Link Indicator

When active the LED indicates that the camera is detected and is connected to an Ethernet network.

Phantom CineFlash Recording Indicator

The Phantom CineFlash Recording Indicator will be active (red) when a Cine is being saved to the CineFlash. Do not

remove the CineFlash during this process.

4.7.1.8 Phantom Miro eX4

The LED indicators below provide you with a visual representation of the camera's operational state, and communication status when in the following states:

OPERATION	ETHERNET	POWER	CAPTURE
Power Up Diagnostics	Red, to Magenta, to Blue	Green, to Magenta, then Green (Power Supply connected to fully charged battery) Blue/White (Power Supply connected, battery charging) Orange (Battery Power)	Inactive, then flashes one time to magenta, and returns to an inactive state.
Capture State	Blue	Green (Power Supply connected) Orange (Battery Power)	Red
Camera Triggered	Blue	Green (Power Supply connected) Orange (Battery Power)	Magenta while filling the camera's RAM, then turns Blue when the buffer is full.
Cine Stored	Blue	Green (Power Supply connected) Orange (Battery Power)	Blue
Saving to an External Storage Device	Blue	Green (Power Supply connected). Orange (Battery Power)	Blue
Saving to Non-Volatile Type1 CompactFlash® Memory Card	Blue	Green (Power Supply connected) Orange (Battery Power)	Blue

4.7.2 Discontinued Cameras

Vision Research categorizes Phantom cameras as Discontinued for cameras that are no longer being manufactured or sold, except as refurbished products. These products will continue to receive full support from Vision Research for 5 years. However, all development has stopped and no new features will be added. Service contracts will continue to be available for terms that do not extend into the obsolescence of the products in 5 years.

4.7.2.1 Phantom 65

The LED indicators below provide you with a visual representation of the camera's operational state, and communication status.

Power Indicator

The Power LED provides a visual indication of camera power status and firmware integrity. If power is being supplied to the camera, and this LED is not lit, it indicates an error has occurred in the camera firmware. If this happens it is best to reboot the camera to correct the error.

Capture Indicator

The Capture LED provides a visual indication of the cameras operational states. By factory default, the camera is placed into the Preview - Waiting for Pre-trigger mode when the camera is powered on, unless it has otherwise been user-configured to start in the Recording waiting for trigger (capture) mode. Once in the Capture mode the camera starts recording images into the cameras circular memory buffer (RAM). Upon detection of a trigger signal, the camera is instructed to stop writing to the cameras internal memory buffer, once the number of specified Post Trigger frames has been reached, and the camera will be placed into the Preview mode. If the camera has been configured to automatically save the images to Flash the camera will, at this point write the images stored in the cameras RAM to the Flash module.

User intervention is required to either save the Cine to an external drive, or to put the camera back into the capture mode from the Setup and Recording screen.

The following will indicate the camera's operational state described above:

- Off Preview or Preview - Waiting for Trigger
- On Recording waiting for trigger (capture)

Ethernet Activity Indicator

When active the LED indicates data is being transferred between the camera and the Phantom Control Unit computer.

Ethernet Link Indicator

When active the LED indicates that the camera is detected and is connected to an Ethernet network.

4.7.2.2 Phantom HD Series

The discontinued Phantom HD Series cameras include:

CAMERA MODEL	DISCONTINUED DATE	OBSOLETE DATE
Phantom HD Gold	31-Dec-2011	31-Dec-2016
Phantom HD	31-Dec-2011	31-Dec-2016

The LED indicators below provide you with a visual representation of the camera's operational state, and communication status.

Power Indicator

The Power LED provides a visual indication of camera power status and firmware integrity. If power is being supplied to the camera, and this LED is not lit, it indicates an error has occurred in the camera firmware. If this happens it is best to reboot the camera to correct the error.

Capture Indicator

The Capture LED provides a visual indication of the camera's operational states. By factory default, the camera is placed into the Preview - Waiting for Pre-trigger mode when the camera is powered on, unless it has otherwise been user-configured to start in the Recording waiting for trigger (capture) mode. Once in the Capture mode the camera starts recording images into the camera's circular memory buffer (RAM). Upon detection of a trigger signal, the camera is instructed to stop writing to the camera's internal memory buffer, once the number of specified Post Trigger frames has been reached, and the camera will be placed into the Preview mode. If the camera has been configured to automatically save the images to Flash the camera will, at this point write the images stored in the camera's RAM to the Flash module.

User intervention is required to either save the Cine to an external drive, or to put the camera back into the capture mode from the Setup and Recording screen.

The following will indicate the camera's operational state described above:

- Off Preview or Preview - Waiting for Trigger
- On Recording waiting for trigger (capture)

Ethernet Activity Indicator

When active the LED indicates data is being transferred between the camera and the Phantom Control Unit computer.

Ethernet Link Indicator

When active the LED indicates that the camera is detected and is connected to an Ethernet network.

4.7.2.3 Phantom UHS xx10 Series

The discontinued Phantom HD Series cameras include:

CAMERA MODEL	DISCONTINUED DATE	OBSOLETE DATE
Phantom v2010	31-Dec-2014	31-Dec-2019
Phantom v1610	31-Dec-2014	31-Dec-2019
Phantom v1210	31-Dec-2014	31-Dec-2019

The LED indicators below provide you with a visual representation of the camera's operational state, and communication status.

Power Indicator

The Power LED provides a visual indication of camera power status and firmware integrity. If power is being supplied to the camera, and this LED is not lit, it indicates an error has occurred in the camera firmware. If this happens it is best to reboot the camera to correct the error.

Capture Indicator

The Capture LED provides a visual indication of the camera's operational states. By factory default, the camera is placed into the Preview - Waiting for Pre-trigger mode when the camera is powered on, unless it has otherwise been user-configured to start in the Recording waiting for trigger (capture) mode. Once in the Capture mode the camera starts recording images into the camera's circular memory buffer (RAM). Upon detection of a trigger signal, the camera is instructed to stop writing to the camera's internal memory buffer, once the number of specified Post Trigger frames has been reached, and the camera will be placed into the Preview mode. If the camera has been configured to automatically save the images to Flash the camera will, at this point write the images stored in the camera's RAM to the Flash module.

User intervention is required to either save the Cine to an external drive, or to put the camera back into the capture mode

from the Setup and Recording screen.

The following will indicate the camera's operational state described above:

- Off Preview or Preview - Waiting for Trigger
- On Recording waiting for trigger (capture)

Ethernet Activity Indicator

When active the LED indicates data is being transferred between the camera and the Phantom Control Unit computer.

Ethernet Link Indicator

When active the LED indicates that the camera is detected and is connected to an Ethernet network.

GenLock Indicator

When active the LED indicates that an inbound composite video signal is being used to synchronize the playback to a video signal, or the synchronization of live video by synchronizing the SDI outputs to the GenLock signal.

4.7.2.4 Phantom Vx11 Series

The discontinued Phantom Vx11 Series cameras include:

CAMERA MODEL	DISCONTINUED DATE	OBSOLETE DATE
Phantom v311	14-Apr-2014	14-Apr-2019
Phantom v211	04-Apr-2014	04-Apr-2019

The LED indicators below provide you with a visual representation of the camera's operational state, and communication status.

The LED indicators below provide you with a visual representation of the camera's operational state, and communication status.

Power Indicator

The Power LED provides a visual indication of camera power status and firmware integrity. If power is being supplied to the camera, and this LED is not lit, it indicates an error has occurred in the camera firmware. If this happens it is best to reboot the camera to correct the error.

Capture Indicator

The Capture LED provides a visual indication of the cameras operational states. By factory default, the camera is placed into the Preview - Waiting for Pre-trigger mode when the camera is powered on, unless it has otherwise been user-configured to start in the Recording waiting for trigger (capture) mode. Once in the Capture mode the camera starts recording images into the cameras circular memory buffer (RAM). Upon detection of a trigger signal, the camera is instructed to stop writing to the cameras internal memory buffer, once the number of specified Post Trigger frames has been reached, and the camera will be placed into the Preview mode. If the camera has been configured to automatically save the images to Flash the camera will, at this point write the images stored in the cameras RAM to the Flash module.

User intervention is required to either save the Cine to an external drive, or to put the camera back into the capture mode from the Setup and Recording screen.

The following will indicate the camera's operational state described above:

- Off Preview or Preview - Waiting for Trigger
- On Recording waiting for trigger (capture)

Ethernet Activity Indicator

When active the LED indicates data is being transferred between the camera and the Phantom Control Unit computer.

Ethernet Link Indicator

When active the LED indicates that the camera is detected and is connected to an Ethernet network.

GenLock Indicator

When active the LED indicates that an inbound composite video signal is being used to synchronize the playback to a video signal, or the synchronization of live video by synchronizing the SDI outputs to the GenLock signal.

4.7.2.5 Phantom v640

The LED indicators below provide you with a visual representation of the camera's operational state, and communication status.

Power Indicator

The Power LED provides a visual indication of camera power status and firmware integrity. If power is being supplied to the camera, and this LED is not lit, it indicates an error has occurred in the camera firmware. If this happens it is best to reboot the camera to correct the error.

Capture Indicator

The Capture LED provides a visual indication of the cameras operational states. By factory default, the camera is placed into the Preview - Waiting for Pre-trigger mode when the camera is powered on, unless it has otherwise been user-configured to start in the Recording waiting for trigger (capture) mode. Once in the Capture mode the camera starts recording images into the cameras circular memory buffer (RAM). Upon detection of a trigger signal, the camera is instructed to stop writing to the cameras internal memory buffer, once the number of specified Post Trigger frames has been reached, and the camera will be placed into the Preview mode. If the camera has been configured to automatically save the images to Flash the camera will, at this point write the images stored in the cameras RAM to the Flash module.

User intervention is required to either save the Cine to an external drive, or to put the camera back into the capture mode from the Setup and Recording screen.

The following will indicate the camera's operational state described above:

- Off Preview or Preview - Waiting for Trigger
- On Recording waiting for trigger (capture)

Communication Indicator

When active the LED indicates data is being transferred between the camera and the Phantom Control Unit computer.

Ethernet Activity Indicator

When active the LED indicates data is being transferred between the camera and the Phantom Control Unit computer.

Ethernet Link Indicator

When active the LED indicates that the camera is detected and is connected to an Ethernet network.

4.7.2.6 Phantom Vx10 Series

The discontinued Phantom Vx10 Series cameras include:

CAMERA MODEL	DISCONTINUED DATE	OBSOLETE DATE
Phantom v710	07-Sept-2011	07-Sept-2016
Phantom v310	07-Sept-2011	07-Sept-2016
Phantom v210	07-Sept-2011	07-Sept-2016

The LED indicators below provide you with a visual representation of the camera's operational state, and communication status.

Power Indicator

The Power LED provides a visual indication of camera power status and firmware integrity. If power is being supplied to the camera, and this LED is not lit, it indicates an error has occurred in the camera firmware. If this happens it is best to reboot the camera to correct the error.

Capture Indicator

The Capture LED provides a visual indication of the cameras operational states. By factory default, the camera is placed into the Preview - Waiting for Pre-trigger mode when the camera is powered on, unless it has otherwise been user-configured to start in the Recording waiting for trigger (capture) mode. Once in the Capture mode the camera starts recording images into the cameras circular memory buffer (RAM). Upon detection of a trigger signal, the camera is instructed to stop writing to the cameras internal memory buffer, once the number of specified Post Trigger frames has been reached, and the camera will be placed into the Preview mode. If the camera has been configured to automatically save the images to Flash the camera will, at this point write the images stored in the cameras RAM to the Flash module.

User intervention is required to either save the Cine to an external drive, or to put the camera back into the capture mode from the Setup and Recording screen.

The following will indicate the camera's operational state described above:

- Off Preview or Preview - Waiting for Trigger
- On Recording waiting for trigger (capture)

Communication Indicator

When active the LED indicates data is being transferred between the camera and the Phantom Control Unit computer.

Ethernet Activity Indicator

When active the LED indicates data is being transferred between the camera and the Phantom Control Unit computer.

Ethernet Link Indicator

When active the LED indicates that the camera is detected and is connected to an Ethernet network.

4.7.2.7 Phantom Legacy v-Series

The discontinued Phantom Legacy v-Series cameras include:

CAMERA MODEL	DISCONTINUED DATE	OBSOLETE DATE
Phantom v12.1	07-Sept-2011	07-Sept-2016
Phantom v10	30-June-2012	30-June-2017

Phantom v9.1	30-June-2012	30-June-2017
Phantom v7.3	14-August-2014	14-August-2019

4.7.2.7.1 Phantom v12.1

The LED indicators below provide you with a visual representation of the camera's operational state, and communication status.

Power Indicator

The Power LED provides a visual indication of camera power status and firmware integrity. If power is being supplied to the camera, and this LED is not lit, it indicates an error has occurred in the camera firmware. If this happens it is best to reboot the camera to correct the error.

Capture Indicator

The Capture LED provides a visual indication of the cameras operational states. By factory default, the camera is placed into the Preview - Waiting for Pre-trigger mode when the camera is powered on, unless it has otherwise been user-configured to start in the Recording waiting for trigger (capture) mode. Once in the Capture mode the camera starts recording images into the cameras circular memory buffer (RAM). Upon detection of a trigger signal, the camera is instructed to stop writing to the cameras internal memory buffer, once the number of specified Post Trigger frames has been reached, and the camera will be placed into the Preview mode. If the camera has been configured to automatically save the images to Flash the camera will, at this point write the images stored in the cameras RAM to the Flash module.

User intervention is required to either save the Cine to an external drive, or to put the camera back into the capture mode from the Setup and Recording screen.

The following will indicate the camera's operational state described above:

- Off Preview or Preview - Waiting for Trigger
- On Recording waiting for trigger (capture)

Communication Indicator

When active the LED indicates data is being transferred between the camera and the Phantom Control Unit computer.

Ethernet Activity Indicator

When active the LED indicates data is being transferred between the camera and the Phantom Control Unit computer.

Ethernet Link Indicator

When active the LED indicates that the camera is detected and is connected to an Ethernet network.

4.7.2.7.2 Phantom v10

The LED indicators below provide you with a visual representation of the camera's operational state, and communication status.

Power Indicator

The Power LED provides a visual indication of camera power status and firmware integrity. If power is being supplied to the camera, and this LED is not lit, it indicates an error has occurred in the camera firmware. If this happens it is best to reboot the camera to correct the error.

Capture Indicator

The Capture LED provides a visual indication of the cameras operational states. By factory default, the camera is placed into the Preview - Waiting for Pre-trigger mode when the camera is powered on, unless it has otherwise been user-configured to start in the Recording waiting for trigger (capture) mode. Once in the Capture mode the camera starts recording images into the cameras circular memory buffer (RAM). Upon detection of a trigger signal, the camera is instructed to stop writing to the cameras internal memory buffer, once the number of specified Post Trigger frames has been reached, and the camera will be placed into the Preview mode. If the camera has been configured to automatically save the images to Flash the camera will, at this point write the images stored in the cameras RAM to the Flash module.

User intervention is required to either save the Cine to an external drive, or to put the camera back into the capture mode from the Setup and Recording screen.

The following will indicate the camera's operational state described above:

- Off Preview or Preview - Waiting for Trigger
- On Recording waiting for trigger (capture)

Communication Indicator

When active the LED indicates data is being transferred between the camera and the Phantom Control Unit computer.

Ethernet Activity Indicator

When active the LED indicates data is being transferred between the camera and the Phantom Control Unit computer.

Ethernet Link Indicator

When active the LED indicates that the camera is detected and is connected to an Ethernet network.

4.7.2.7.3 Phantom v9.1

The LED indicators below provide you with a visual representation of the camera's operational state, and communication status.

Power Indicator

The Power LED provides a visual indication of camera power status and firmware integrity. If power is being supplied to the camera, and this LED is not lit, it indicates an error has occurred in the camera firmware. If this happens it is best to reboot the camera to correct the error.

Capture Indicator

The Capture LED provides a visual indication of the cameras operational states. By factory default, the camera is placed into the Preview - Waiting for Pre-trigger mode when the camera is powered on, unless it has otherwise been user-configured to start in the Recording waiting for trigger (capture) mode. Once in the Capture mode the camera starts recording images into the cameras circular memory buffer (RAM). Upon detection of a trigger signal, the camera is instructed to stop writing to the cameras internal memory buffer, once the number of specified Post Trigger frames has been reached, and the camera will be placed into the Preview mode. If the camera has been configured to automatically save the images to Flash the camera will, at this point write the images stored in the cameras RAM to the Flash module.

User intervention is required to either save the Cine to an external drive, or to put the camera back into the capture mode from the Setup and Recording screen.

The following will indicate the camera's operational state described above:

- Off Preview or Preview - Waiting for Trigger
- On Recording waiting for trigger (capture)

Communication Indicator

When active the LED indicates data is being transferred between the camera and the Phantom Control Unit computer.

Ethernet Activity Indicator

When active the LED indicates data is being transferred between the camera and the Phantom Control Unit computer.

Ethernet Link Indicator

When active the LED indicates that the camera is detected and is connected to an Ethernet network.

4.7.2.7.4 Phantom v7.3

The LED indicators below provide you with a visual representation of the camera's operational state, and communication status.

Power Indicator

The Power LED provides a visual indication of camera power status and firmware integrity. If power is being supplied to the camera, and this LED is not lit, it indicates an error has occurred in the camera firmware. If this happens it is best to reboot the camera to correct the error.

Capture Indicator

The Capture LED provides a visual indication of the cameras operational states. By factory default, the camera is placed into the Preview - Waiting for Pre-trigger mode when the camera is powered on, unless it has otherwise been user-configured to start in the Recording waiting for trigger (capture) mode. Once in the Capture mode the camera starts recording images into the cameras circular memory buffer (RAM). Upon detection of a trigger signal, the camera is instructed to stop writing to the cameras internal memory buffer, once the number of specified Post Trigger frames has been reached, and the camera will be placed into the Preview mode. If the camera has been configured to automatically save the images to Flash the camera will, at this point write the images stored in the cameras RAM to the Flash module.

User intervention is required to either save the Cine to an external drive, or to put the camera back into the capture mode from the Setup and Recording screen.

The following will indicate the camera's operational state described above:

- Off Preview or Preview - Waiting for Trigger
- On Recording waiting for trigger (capture)

Communication Indicator

When active the LED indicates data is being transferred between the camera and the Phantom Control Unit computer.

Ethernet Activity Indicator

When active the LED indicates data is being transferred between the camera and the Phantom Control Unit computer.

Ethernet Link Indicator

When active the LED indicates that the camera is detected and is connected to an Ethernet network.

4.7.2.8 Phantom ir300

The LED indicators below provide you with a visual representation of the camera's operational state, and communication status.

Power Indicator

The Power LED provides a visual indication of camera power status and firmware integrity. If power is being supplied to the camera, and this LED is not lit, it indicates an error has occurred in the camera firmware. If this happens it is best to reboot the camera to correct the error.

Capture Indicator

The Capture LED provides a visual indication of the cameras operational states. By factory default, the camera is placed into the Preview - Waiting for Pre-trigger mode when the camera is powered on, unless it has otherwise been user-configured to start in the Recording waiting for trigger (capture) mode. Once in the Capture mode the camera starts recording images into the cameras circular memory buffer (RAM). Upon detection of a trigger signal, the camera is instructed to stop writing to the cameras internal memory buffer, once the number of specified Post Trigger frames has been reached, and the camera will be placed into the Preview mode. If the camera has been configured to automatically save the images to Flash the camera will, at this point write the images stored in the cameras RAM to the Flash module.

User intervention is required to either save the Cine to an external drive, or to put the camera back into the capture mode from the Setup and Recording screen.

The following will indicate the camera's operational state described above:

- Off Preview or Preview - Waiting for Trigger
- On Recording waiting for trigger (capture)

Communication Indicator

When active the LED indicates data is being transferred between the camera and the Phantom Control Unit computer.

Ethernet Activity Indicator

When active the LED indicates data is being transferred between the camera and the Phantom Control Unit computer.

Ethernet Link Indicator

When active the LED indicates that the camera is detected and is connected to an Ethernet network.

4.7.2.9 Phantom Miro Airborne Series

The discontinued Phantom Miro Airborne Series cameras include:

CAMERA MODEL	DISCONTINUED DATE	OBSOLETE DATE
Phantom Miro Airborne HD	10-Jul-2015	10-Jul-2020
Phantom Miro Airborne	10-Jul-2015	10-Jul-2020

The LED indicators below provide you with a visual representation of the camera's operational state, and communication status when in the following states:

OPERATION	ETHERNET	POWER	CAPTURE
Power Up Diagnostics	Turns from Red to Magenta, back to Red, then to Orange (flicker), and flashes Blue/Green.	Turns from Green to Magenta, then to: Blue/White (Power Supply connected)	Inactive, then flash one time to magenta, and return to an inactive state.

		Orange (Battery Power)	
Capture State	Flashes Blue/Green	Blue/White (Power Supply connected) Orange (Battery Power)	Red
Camera Triggered	Flashes Blue/Green	Blue/White turns to: Green (Power Supply connected) Orange (Battery Power)	Magenta while filling the camera's RAM, then turns to Blue when the buffer is full.
Cine Stored	Flashes Blue/Green	Green (Power Supply connected) Orange (Battery Power)	Blue
Saving Cine to External Storage Device	Flashes Blue/Green	Green (Power Supply connected) Orange (Battery Power)	Blue
Saving to Non-Volatile Type1 CompactFlash Memory Card	Flashes Blue/Green	Green (Power Supply connected) Orange (Battery Power)	Blue
Power Down	Turns from Green to Inactive	Turns from Blue/White to Orange, to finally inactive (approx. 30sec.)	Inactive

4.7.2.10 Phantom Miro eX Series

The discontinued Phantom Miro eX Series cameras include:

CAMERA MODEL	DISCONTINUED DATE	OBSOLETE DATE
Phantom Miro eX2	18-Feb-2015	17-Feb-2020
Phantom Miro eX3	14-Nov-2011	14-Nov-2016
Phantom Miro eX1	14-Nov-2011	14-Nov-2016



The camera will run on battery power if the camera *has image data stored in the camera's RAM.*

The LED indicators below provide you with a visual representation of the camera's operational state, and communication status when in the following states:

OPERATION	ETHERNET	POWER	CAPTURE
Power Up Diagnostics	Red, to Magenta, to Blue	Green, to Magenta, then Green (Power Supply connected to fully charged battery) Blue/White (Power Supply connected, battery charging) Orange (Battery Power)	Inactive, then flashes one time to magenta, and returns to an inactive state.
Capture State	Blue	Green (Power Supply connected) Orange (Battery Power)	Red
Camera Triggered	Blue	Green (Power Supply connected) Orange (Battery Power)	Magenta while filling the camera's RAM, then turns Blue when the buffer is full.
Cine Stored	Blue	Green (Power Supply connected) Orange (Battery Power)	Blue
Saving to an External Storage Device	Blue	Green (Power Supply connected). Orange (Battery Power)	Blue
Saving to Non-Volatile Type1 CompactFlash® Memory Card	Blue	Green (Power Supply connected) Orange (Battery Power)	Blue

4.7.2.11 Phantom Miro 3



The camera will run on battery power if the camera **has image data stored in the camera's RAM.**

The LED indicators below provide you with a visual representation of the camera's operational state, and communication status when in the following states:

OPERATION	ETHERNET	POWER	CAPTURE
Power Up Diagnostics	Red, to Magenta, back to Red, then Orange (flicker), and flashes Blue/Green	Turns from Green to Magenta, then to: Blue/White (Power Supply connected) Orange (Battery Power)	Inactive, then flash one time to magenta, and return to an inactive state.

Capture State	Flashes Blue/Green	Blue/White turns to: Green (Power Supply connected) Orange (Battery Power)	Red
Camera Triggered	Flashes Blue/Green	Blue/White turns to: Green (Power Supply connected) Orange (Battery Power)	Magenta while filling the camera's RAM, then turns to Blue when the buffer is full.
Cine Stored	Flashes Blue/Green	Green (Power Supply connected) Orange (Battery Power)	Blue
Saving Cine to External Storage Device	Flashes Blue/Green	Green (Power Supply connected) Orange (Battery Power)	Blue
Saving to Integrated Non-Volatile Flash Memory	Flashes Blue/Green	Green (Power Supply connected) Orange (Battery Power)	Blue
Power Down	Turns from Green to Inactive	Turns from Blue/White to Orange, to finally inactive (approx. 30 sec.)	Inactive

4.7.3 Obsolete Cameras

Vision Research categorizes Phantom cameras as Obsolete for cameras that are no longer being manufactured or sold. These products no longer receive full support from Vision Research. All development has stopped and no new features will be added. No service contracts will be available.

4.7.3.1 Phantom v12.0

The LED indicators below provide you with a visual representation of the camera's operational state, and communication status.

Power Indicator

The Power LED provides a visual indication of camera power status and firmware integrity. If power is being supplied to the camera, and this LED is not lit, it indicates an error has occurred in the camera firmware. If this happens it is best to reboot the camera to correct the error.

Capture Indicator

The Capture LED provides a visual indication of the camera's operational states. By factory default, the camera is placed into the Preview - Waiting for Pre-trigger mode when the camera is powered on, unless it has otherwise been user-configured to start in the Recording waiting for trigger (capture) mode. Once in the Capture mode the camera starts recording images into the camera's circular memory buffer (RAM). Upon detection of a trigger signal, the camera is instructed to stop writing to the camera's internal memory buffer, once the number of specified Post Trigger frames has been reached, and the camera will be placed into the Preview mode. If the camera has been configured to automatically save the images to Flash the camera will, at this point write the images stored in the camera's RAM to the Flash module.

User intervention is required to either save the Cine to an external drive, or to put the camera back into the capture mode from the Setup and Recording screen.

The following will indicate the camera's operational state described above:

- Off Preview or Preview - Waiting for Trigger
- On Recording waiting for trigger (capture)

Communication Indicator

When active the LED indicates data is being transferred between the camera and the Phantom Control Unit computer.

Ethernet Activity Indicator

When active the LED indicates data is being transferred between the camera and the Phantom Control Unit computer.

Ethernet Link Indicator

When active the LED indicates that the camera is detected and is connected to an Ethernet network.

4.7.3.2 Phantom v9.0

The LED indicators below provide you with a visual representation of the camera's operational state, and communication status.

Power Indicator

The Power LED provides a visual indication of camera power status and firmware integrity. If power is being supplied to the camera, and this LED is not lit, it indicates an error has occurred in the camera firmware. If this happens it is best to reboot the camera to correct the error.

Capture Indicator

The Capture LED provides a visual indication of the cameras operational states. By factory default, the camera is placed into the Preview - Waiting for Pre-trigger mode when the camera is powered on, unless it has otherwise been user-configured to start in the Recording waiting for trigger (capture) mode. Once in the Capture mode the camera starts recording images into the cameras circular memory buffer (RAM). Upon detection of a trigger signal, the camera is instructed to stop writing to the cameras internal memory buffer, once the number of specified Post Trigger frames has been reached, and the camera will be placed into the Preview mode. If the camera has been configured to automatically save the images to Flash the camera will, at this point write the images stored in the cameras RAM to the Flash module.

User intervention is required to either save the Cine to an external drive, or to put the camera back into the capture mode from the Setup and Recording screen.

The following will indicate the camera's operational state described above:

- Off Preview or Preview - Waiting for Trigger
- On Recording waiting for trigger (capture)

Communication Indicator

When active the LED indicates data is being transferred between the camera and the Phantom Control Unit computer.

Ethernet Activity Indicator

When active the LED indicates data is being transferred between the camera and the Phantom Control Unit computer.

Ethernet Link Indicator

When active the LED indicates that the camera is detected and is connected to an Ethernet network.

4.7.3.3 Phantom v7.2

The LED indicators below provide you with a visual representation of the camera's operational state, and communication status.

Power Indicator

The Power LED provides a visual indication of camera power status and firmware integrity. If power is being supplied to the camera, and this LED is not lit, it indicates an error has occurred in the camera firmware. If this happens it is best to reboot the camera to correct the error.

Capture Indicator

The Capture LED provides a visual indication of the cameras operational states. By factory default, the camera is placed into the Preview - Waiting for Pre-trigger mode when the camera is powered on, unless it has otherwise been user-configured to start in the Recording waiting for trigger (capture) mode. Once in the Capture mode the camera starts recording images into the cameras circular memory buffer (RAM). Upon detection of a trigger signal, the camera is instructed to stop writing to the cameras internal memory buffer, once the number of specified Post Trigger frames has been reached, and the camera will be placed into the Preview mode. If the camera has been configured to automatically save the images to Flash the camera will, at this point write the images stored in the cameras RAM to the Flash module.

User intervention is required to either save the Cine to an external drive, or to put the camera back into the capture mode from the Setup and Recording screen.

The following will indicate the camera's operational state described above:

- Off Preview or Preview - Waiting for Trigger
- On Recording waiting for trigger (capture)

Communication Indicator

When active the LED indicates data is being transferred between the camera and the Phantom Control Unit computer.

Ethernet Activity Indicator

When active the LED indicates data is being transferred between the camera and the Phantom Control Unit computer.

Ethernet Link Indicator

When active the LED indicates that the camera is detected and is connected to an Ethernet network.

4.7.3.4 Phantom v7.1

The LED indicators below provide you with a visual representation of the camera's operational state, and communication status.

Power Indicator

The Power LED provides a visual indication of camera power status and firmware integrity. If power is being supplied to the camera, and this LED is not lit, it indicates an error has occurred in the camera firmware. If this happens it is best to reboot the camera to correct the error.

Capture Indicator

The Capture LED provides a visual indication of the cameras operational states. By factory default, the camera is placed into the Preview - Waiting for Pre-trigger mode when the camera is powered on, unless it has otherwise been user-configured to start in the Recording waiting for trigger (capture) mode. Once in the Capture mode the camera starts recording images into the cameras circular memory buffer (RAM). Upon detection of a trigger signal, the camera is instructed to stop writing to the cameras internal memory buffer, once the number of specified Post Trigger frames has

been reached, and the camera will be placed into the Preview mode. If the camera has been configured to automatically save the images to Flash the camera will, at this point write the images stored in the cameras RAM to the Flash module.

User intervention is required to either save the Cine to an external drive, or to put the camera back into the capture mode from the Setup and Recording screen.

The following will indicate the camera's operational state described above:

- Off Preview or Preview - Waiting for Trigger
- On Recording waiting for trigger (capture)

Communication Indicator

When active the LED indicates data is being transferred between the camera and the Phantom Control Unit computer.

Ethernet Activity Indicator

When active the LED indicates data is being transferred between the camera and the Phantom Control Unit computer.

Ethernet Link Indicator

When active the LED indicates that the camera is detected and is connected to an Ethernet network.

4.7.3.5 Phantom v7.0g

The LED indicators below provide you with a visual representation of the camera's operational state, and communication status.

Power Indicator

The Power LED provides a visual indication of camera power status and firmware integrity. If power is being supplied to the camera, and this LED is not lit, it indicates an error has occurred in the camera firmware. If this happens it is best to reboot the camera to correct the error.

Capture Indicator

The Capture LED provides a visual indication of the cameras operational states. By factory default, the camera is placed into the Preview - Waiting for Pre-trigger mode when the camera is powered on, unless it has otherwise been user-configured to start in the Recording waiting for trigger (capture) mode. Once in the Capture mode the camera starts recording images into the cameras circular memory buffer (RAM). Upon detection of a trigger signal, the camera is instructed to stop writing to the cameras internal memory buffer, once the number of specified Post Trigger frames has been reached, and the camera will be placed into the Preview mode. If the camera has been configured to automatically save the images to Flash the camera will, at this point write the images stored in the cameras RAM to the Flash module.

User intervention is required to either save the Cine to an external drive, or to put the camera back into the capture mode from the Setup and Recording screen.

The following will indicate the camera's operational state described above:

- Off Preview or Preview - Waiting for Trigger
- On Recording waiting for trigger (capture)

Communication Indicator

When active the LED indicates data is being transferred between the camera and the Phantom Control Unit computer.

Ethernet Activity Indicator

When active the LED indicates data is being transferred between the camera and the Phantom Control Unit computer.

Ethernet Link Indicator

When active the LED indicates that the camera is detected and is connected to an Ethernet network.

4.7.3.6 Phantom v6.2e

The LED indicators below provide you with a visual representation of the camera's operational state, and communication status.

Control Unit Imager Head Connectors

The Phantom Control Unit Imager Head connectors are used to connect the Phantom Control Unit to the Imager Heads (up to 4 maximum). Each connector connects to a specific Imager Head (see Imager Head Number below) via the Imager Head cable.

Imager Head Connectors

The Imager Head connectors are used to connect the Imager Heads to the Phantom Control Unit (up to 4 maximum). Each connector connects a specific Imager Head to the Phantom Control Unit (see Imager Head Number below) via the Imager Head cable.

Power Indicator

The Power LED provides a visual indication of camera power status and firmware integrity. If power is being supplied to the camera, and this LED is not lit, it indicates an error has occurred in the camera firmware. If this happens it is best to reboot the camera to correct the error.

Capture Indicator

The Capture LED provides a visual indication of the cameras operational states. By factory default, the camera is placed into the Preview - Waiting for Pre-trigger mode when the camera is powered on, unless it has otherwise been user-configured to start in the Recording waiting for trigger (capture) mode. Once in the Capture mode the camera starts recording images into the cameras circular memory buffer (RAM). Upon detection of a trigger signal, the camera is instructed to stop writing to the cameras internal memory buffer, once the number of specified Post Trigger frames has been reached, and the camera will be placed into the Preview mode. If the camera has been configured to automatically save the images to Flash the camera will, at this point write the images stored in the cameras RAM to the Flash module.

User intervention is required to either save the Cine to an external drive, or to put the camera back into the capture mode from the Setup and Recording screen.

The following will indicate the camera's operational state described above:

- Off Preview or Preview - Waiting for Trigger
- On Recording waiting for trigger (capture)

Communication Indicator

When active the LED indicates data is being transferred between the camera and the Phantom Control Unit computer.

4.7.3.7 Phantom v6.1

The LED indicators below provide you with a visual representation of the camera's operational state, and communication status.

Control Unit Imager Head Connectors

The Phantom Control Unit Imager Head connectors are used to connect the Phantom Control Unit to the Imager Heads (up to 4 maximum). Each connector connects to a specific Imager Head (see Imager Head Number below) via the Imager

Head cable.

Imager Head Connectors

The Imager Head connectors are used to connect the Imager Heads to the Phantom Control Unit (up to 4 maximum). Each connector connects a specific Imager Head to the Phantom Control Unit (see Imager Head Number below) via the Imager Head cable.

Camera Serial Number

Each Imager Head (camera sensor) has been assigned a unique Serial Number by Vision Research, which is used to create the .stg (factory default calibration settings) file.

Imager Head Number

The Imager Head Number indicates which of the four Phantom Control Unit connectors the Imager Head (camera) should connect to.

Power Indicator

The Power LED provides a visual indication of camera power status and firmware integrity. If power is being supplied to the camera, and this LED is not lit, it indicates an error has occurred in the camera firmware. If this happens it is best to reboot the camera to correct the error.

Capture Indicator

The Capture LED provides a visual indication of the camera's operational states. By factory default, the camera is placed into the Preview - Waiting for Pre-trigger mode when the camera is powered on, unless it has otherwise been user-configured to start in the Recording waiting for trigger (capture) mode. Once in the Capture mode the camera starts recording images into the camera's circular memory buffer (RAM). Upon detection of a trigger signal, the camera is instructed to stop writing to the camera's internal memory buffer, once the number of specified Post Trigger frames has been reached, and the camera will be placed into the Preview mode. If the camera has been configured to automatically save the images to Flash the camera will, at this point write the images stored in the camera's RAM to the Flash module.

User intervention is required to either save the Cine to an external drive, or to put the camera back into the capture mode from the Setup and Recording screen.

The following will indicate the camera's operational state described above:

- Off Preview or Preview - Waiting for Trigger
- On Recording waiting for trigger (capture)

Communication Indicator

When active the LED indicates data is being transferred between the camera and the Phantom Control Unit computer.

4.7.3.8 Phantom v6.0

The LED indicators below provide you with a visual representation of the camera's operational state, and communication status.

Control Unit Imager Head Connectors

The Phantom Control Unit Imager Head connectors are used to connect the Phantom Control Unit to the Imager Heads (up to 4 maximum). Each connector connects to a specific Imager Head (see Imager Head Number below) via the Imager Head cable.

Imager Head Connectors

The Imager Head connectors are used to connect the Imager Heads to the Phantom Control Unit (up to 4 maximum). Each connector connects a specific Imager Head to the Phantom Control Unit (see Imager Head Number below) via the Imager Head cable.

Camera Serial Number

Each Imager Head (camera sensor) has been assigned a unique Serial Number by Vision Research, which is used to create the .stg (factory default calibration settings) file.

Imager Head Number

The Imager Head Number indicates which of the four Phantom Control Unit connectors the Imager Head (camera) should connect to.

Power Indicator

The Power LED provides a visual indication of camera power status and firmware integrity. If power is being supplied to the camera, and this LED is not lit, it indicates an error has occurred in the camera firmware. If this happens it is best to reboot the camera to correct the error.

Capture Indicator

The Capture LED provides a visual indication of the camera's operational states. By factory default, the camera is placed into the Preview - Waiting for Pre-trigger mode when the camera is powered on, unless it has otherwise been user-configured to start in the Recording waiting for trigger (capture) mode. Once in the Capture mode the camera starts recording images into the camera's circular memory buffer (RAM). Upon detection of a trigger signal, the camera is instructed to stop writing to the camera's internal memory buffer, once the number of specified Post Trigger frames has been reached, and the camera will be placed into the Preview mode. If the camera has been configured to automatically save the images to Flash the camera will, at this point write the images stored in the camera's RAM to the Flash module.

User intervention is required to either save the Cine to an external drive, or to put the camera back into the capture mode from the Setup and Recording screen.

The following will indicate the camera's operational state described above:

- Off Preview or Preview - Waiting for Trigger
- On Recording waiting for trigger (capture)

Communication Indicator

When active the LED indicates data is being transferred between the camera and the Phantom Control Unit computer.

4.7.3.9 Phantom v5.2

The LED indicators below provide you with a visual representation of the camera's operational state, and communication status.

Power Indicator

The Power LED provides a visual indication of camera power status and firmware integrity. If power is being supplied to the camera, and this LED is not lit, it indicates an error has occurred in the camera firmware. If this happens it is best to reboot the camera to correct the error.

Capture Indicator

The Capture LED provides a visual indication of the camera's operational states. By factory default, the camera is placed into the Preview - Waiting for Pre-trigger mode when the camera is powered on, unless it has otherwise been user-

configured to start in the Recording waiting for trigger (capture) mode. Once in the Capture mode the camera starts recording images into the cameras circular memory buffer (RAM). Upon detection of a trigger signal, the camera is instructed to stop writing to the cameras internal memory buffer, once the number of specified Post Trigger frames has been reached, and the camera will be placed into the Preview mode. If the camera has been configured to automatically save the images to Flash the camera will, at this point write the images stored in the cameras RAM to the Flash module.

User intervention is required to either save the Cine to an external drive, or to put the camera back into the capture mode from the Setup and Recording screen.

The following will indicate the camera's operational state described above:

- Off Preview or Preview - Waiting for Trigger
- On Recording waiting for trigger (capture)

Communication Indicator

When active the LED indicates data is being transferred between the camera and the Phantom Control Unit computer.

Ethernet Activity Indicator

When active the LED indicates data is being transferred between the camera and the Phantom Control Unit computer.

Ethernet Link Indicator

When active the LED indicates that the camera is detected and is connected to an Ethernet network.

4.7.3.10 Phantom v5.1

The LED indicators below provide you with a visual representation of the camera's operational state, and communication status.

Power Indicator

The Power LED provides a visual indication of camera power status and firmware integrity. If power is being supplied to the camera, and this LED is not lit, it indicates an error has occurred in the camera firmware. If this happens it is best to reboot the camera to correct the error.

Capture Indicator

The Capture LED provides a visual indication of the cameras operational states. By factory default, the camera is placed into the Preview - Waiting for Pre-trigger mode when the camera is powered on, unless it has otherwise been user-configured to start in the Recording waiting for trigger (capture) mode. Once in the Capture mode the camera starts recording images into the cameras circular memory buffer (RAM). Upon detection of a trigger signal, the camera is instructed to stop writing to the cameras internal memory buffer, once the number of specified Post Trigger frames has been reached, and the camera will be placed into the Preview mode. If the camera has been configured to automatically save the images to Flash the camera will, at this point write the images stored in the cameras RAM to the Flash module.

User intervention is required to either save the Cine to an external drive, or to put the camera back into the capture mode from the Setup and Recording screen.

The following will indicate the camera's operational state described above:

- Off Preview or Preview - Waiting for Trigger
- On Recording waiting for trigger (capture)

Communication Indicator

When active the LED indicates data is being transferred between the camera and the Phantom Control Unit computer.

Ethernet Activity Indicator

When active the LED indicates data is being transferred between the camera and the Phantom Control Unit computer.

Ethernet Link Indicator

When active the LED indicates that the camera is detected and is connected to an Ethernet network.

4.7.3.11 Phantom v5.0

The LED indicators below provide you with a visual representation of the camera's operational state, and communication status.

Power Indicator

The Power LED provides a visual indication of camera power status and firmware integrity. If power is being supplied to the camera, and this LED is not lit, it indicates an error has occurred in the camera firmware. If this happens it is best to reboot the camera to correct the error.

Capture Indicator

The Capture LED provides a visual indication of the cameras operational states. By factory default, the camera is placed into the Preview - Waiting for Pre-trigger mode when the camera is powered on, unless it has otherwise been user-configured to start in the Recording waiting for trigger (capture) mode. Once in the Capture mode the camera starts recording images into the cameras circular memory buffer (RAM). Upon detection of a trigger signal, the camera is instructed to stop writing to the cameras internal memory buffer, once the number of specified Post Trigger frames has been reached, and the camera will be placed into the Preview mode. If the camera has been configured to automatically save the images to Flash the camera will, at this point write the images stored in the cameras RAM to the Flash module.

User intervention is required to either save the Cine to an external drive, or to put the camera back into the capture mode from the Setup and Recording screen.

The following will indicate the camera's operational state described above:

Off Preview or Preview - Waiting for Trigger

On Recording waiting for trigger (capture)

Communication Indicator

When active the LED indicates data is being transferred between the camera and the Phantom Control Unit computer.

4.7.3.12 Phantom v4.3

The LED indicators below provide you with a visual representation of the camera's operational state, and communication status.

Power Indicator

The Power LED provides a visual indication of camera power status and firmware integrity. If power is being supplied to the camera, and this LED is not lit, it indicates an error has occurred in the camera firmware. If this happens it is best to reboot the camera to correct the error.

Capture Indicator

The Capture LED provides a visual indication of the cameras operational states. By factory default, the camera is placed into the Preview - Waiting for Pre-trigger mode when the camera is powered on, unless it has otherwise been user-configured to start in the Recording waiting for trigger (capture) mode. Once in the Capture mode the camera starts recording images into the cameras circular memory buffer (RAM). Upon detection of a trigger signal, the camera is

instructed to stop writing to the cameras internal memory buffer, once the number of specified Post Trigger frames has been reached, and the camera will be placed into the Preview mode. If the camera has been configured to automatically save the images to Flash the camera will, at this point write the images stored in the cameras RAM to the Flash module.

User intervention is required to either save the Cine to an external drive, or to put the camera back into the capture mode from the Setup and Recording screen.

The following will indicate the camera's operational state described above:

- Off Preview or Preview - Waiting for Trigger
- On Recording waiting for trigger (capture)

Communication Indicator

When active the LED indicates data is being transferred between the camera and the Phantom Control Unit computer.

Ethernet Activity Indicator

When active the LED indicates data is being transferred between the camera and the Phantom Control Unit computer.

Ethernet Link Indicator

When active the LED indicates that the camera is detected and is connected to an Ethernet network.

4.7.3.13 Phantom v4.2

The LED indicators below provide you with a visual representation of the camera's operational state, and communication status.

Power Indicator

The Power LED provides a visual indication of camera power status and firmware integrity. If power is being supplied to the camera, and this LED is not lit, it indicates an error has occurred in the camera firmware. If this happens it is best to reboot the camera to correct the error.

Capture Indicator

The Capture LED provides a visual indication of the cameras operational states. By factory default, the camera is placed into the Preview - Waiting for Pre-trigger mode when the camera is powered on, unless it has otherwise been user-configured to start in the Recording waiting for trigger (capture) mode. Once in the Capture mode the camera starts recording images into the cameras circular memory buffer (RAM). Upon detection of a trigger signal, the camera is instructed to stop writing to the cameras internal memory buffer, once the number of specified Post Trigger frames has been reached, and the camera will be placed into the Preview mode. If the camera has been configured to automatically save the images to Flash the camera will, at this point write the images stored in the cameras RAM to the Flash module.

User intervention is required to either save the Cine to an external drive, or to put the camera back into the capture mode from the Setup and Recording screen.

The following will indicate the camera's operational state described above:

- Off Preview or Preview - Waiting for Trigger
- On Recording waiting for trigger (capture)

Communication Indicator

When active the LED indicates data is being transferred between the camera and the Phantom Control Unit computer.

Ethernet Activity Indicator

When active the LED indicates data is being transferred between the camera and the Phantom Control Unit computer.

Ethernet Link Indicator

When active the LED indicates that the camera is detected and is connected to an Ethernet network.

4.7.3.14 Phantom v4.1

The LED indicators below provide you with a visual representation of the camera's operational state, and communication status.

Power Indicator

The Power LED provides a visual indication of camera power status and firmware integrity. If power is being supplied to the camera, and this LED is not lit, it indicates an error has occurred in the camera firmware. If this happens it is best to reboot the camera to correct the error.

Capture Indicator

The Capture LED provides a visual indication of the cameras operational states. By factory default, the camera is placed into the Preview - Waiting for Pre-trigger mode when the camera is powered on, unless it has otherwise been user-configured to start in the Recording waiting for trigger (capture) mode. Once in the Capture mode the camera starts recording images into the cameras circular memory buffer (RAM). Upon detection of a trigger signal, the camera is instructed to stop writing to the cameras internal memory buffer, once the number of specified Post Trigger frames has been reached, and the camera will be placed into the Preview mode. If the camera has been configured to automatically save the images to Flash the camera will, at this point write the images stored in the cameras RAM to the Flash module.

User intervention is required to either save the Cine to an external drive, or to put the camera back into the capture mode from the Setup and Recording screen.

The following will indicate the camera's operational state described above:

- Off Preview or Preview - Waiting for Trigger
- On Recording waiting for trigger (capture)

4.7.3.15 Phantom Miro 4

The LED indicators below provide you with a visual representation of the camera's operational state, and communication status when in the following states:

OPERATION	ETHERNET	POWER	CAPTURE
Power Up Diagnostics	Red, to Magenta, to Blue	Green, to Magenta, then Green (Power Supply connected to fully charged battery) Blue/White (Power Supply connected, battery charging) Orange (Battery Power)	Inactive, then flashes one time to magenta, and returns to an inactive state.
Capture State	Blue	Green (Power Supply connected) Orange (Battery Power)	Red

Camera Triggered	Blue	Green (Power Supply connected) Orange (Battery Power)	Magenta while filling the camera's RAM, then turns Blue when the buffer is full.
Cine Stored	Blue	Green (Power Supply connected) Orange (Battery Power)	Blue
Saving to an External Storage Device	Blue	Green (Power Supply connected). Orange (Battery Power)	Blue
Saving to Non-Volatile Type1 CompactFlash® Memory Card	Blue	Green (Power Supply connected) Orange (Battery Power)	Blue

4.7.3.16 Phantom Miro 2

The LED indicators below provide you with a visual representation of the camera's operational state, and communication status when in the following states:

OPERATION	ETHERNET	POWER	CAPTURE
Power Up Diagnostics	Red, to Magenta, to Blue	Green, to Magenta, then Green (Power Supply connected to fully charged battery) Blue/White (Power Supply connected, battery charging) Orange (Battery Power)	Inactive, then flashes one time to magenta, and returns to an inactive state.
Capture State	Blue	Green (Power Supply connected) Orange (Battery Power)	Red
Camera Triggered	Blue	Green (Power Supply connected) Orange (Battery Power)	Magenta while filling the camera's RAM, then turns Blue when the buffer is full.
Cine Stored	Blue	Green (Power Supply connected) Orange	Blue

		(Battery Power)	
Saving to an External Storage Device	Blue	Green (Power Supply connected). Orange (Battery Power)	Blue
Saving to Non-Volatile Type1 CompactFlash® Memory Card	Blue	Green (Power Supply connected) Orange (Battery Power)	Blue

4.7.3.17 Phantom Miro 1

The LED indicators below provide you with a visual representation of the camera's operational state, and communication status when in the following states:

OPERATION	ETHERNET	POWER	CAPTURE
Power Up Diagnostics	Red, to Magenta, to Blue	Green, to Magenta, then Green (Power Supply connected to fully charged battery) Blue/White (Power Supply connected, battery charging) Orange (Battery Power)	Inactive, then flashes one time to magenta, and returns to an inactive state.
Capture State	Blue	Green (Power Supply connected) Orange (Battery Power)	Red
Camera Triggered	Blue	Green (Power Supply connected) Orange (Battery Power)	Magenta while filling the camera's RAM, then turns Blue when the buffer is full.
Cine Stored	Blue	Green (Power Supply connected) Orange (Battery Power)	Blue
Saving to an External Storage Device	Blue	Green (Power Supply connected). Orange (Battery Power)	Blue
Saving to Non-Volatile Type1 CompactFlash® Memory	Blue	Green (Power Supply connected)	Blue

Card		Orange (Battery Power)	
------	--	---------------------------	--

4.7.4 Peripherals

4.7.4.1 Phantom CineMag IV

The LED indicators below provide you with a visual representation of the Phantom CineMag IV's operational state, communication status, and memory usage.

Erase Protect Switch

When the erase-protect switch is in the lock position, the CineMag IV cannot be erased. Use an appropriate tool, such as a micro-flathead screwdriver to flip the switch.

Activity Indicator

- Green - read activity
- Red - recording
- Orange - erasing

CineMag Capacity Indicators

The Phantom CineMag Capacity Indicators consist of a group of eight LEDs.

- When the Phantom CineMag is empty all the LEDs will be ON.
- As the Phantom CineMag fills up, the LEDs will turn OFF.
- The last LED will always stay on to indicate power.

4.7.4.2 Phantom CineMag I & II

The LED indicators below provide you with a visual representation of the Phantom CineMag I or II operational state, communication status, and memory usage.

Power Indicator

The Power LED, (when ON), provides a visual indication that power is being supplied to the Phantom CineMag I or II.

Erase Protect Indicator

The Erase Protect LED, (when ON), indicates that the Erase Protect Switch, located underneath the Phantom CineMag I or II, is in the locked position.

Activity Indicator

When active, (ON), the LED indicates data is being transferred to/from the camera and the Phantom CineMag I or II.

FPGA Loader Indicator

The FPGA Loader LED will be:

- ON during power-up diagnostics.

- OFF when Phantom CineMag FPGA's, (Field Programmable Gate Arrays), are programmed properly.

Recording Indicator

When active the LED indicates data is being transferred into the Phantom CineMag.

Phantom CineMag I or II Memory Usage Indicators

The Phantom CineMag I or II Memory Usage Indicators consist of a group of eight LEDs.

- When the Phantom CineMag I or II is empty all the LEDs will be ON.
- As the Phantom CineMag I or II fills up, the LEDs will turn OFF from right to left.
- The left LED will be the last to turn OFF and will blink 10 seconds before the Phantom CineMag I or II is full.

4.7.4.3 Phantom CineStation IV

1Gb / 10Gb Ethernet Activity Indicators

When active the LED indicates data is being transferred between the camera and the Phantom Control Unit computer.

1Gb / 10Gb Ethernet Link Indicators

When active the LED indicates that the camera is detected and is connected to an Ethernet network.

4.7.4.4 Phantom RCU (Remote Control Unit)

The LED indicators below provide you with a visual representation of the camera's operational state, and communication status when in the following states:

OPERATIONAL STATE	RC (REMOTE CONTROL) INDICATOR	CAM(ERA) INDICATOR
Power Up Diagnostics	White for approx 10s, then Flashes red/green for approx 13s, then Cyan for approx 25s	Off
Live Preview, Waiting for Pre-Trigger Mode	Cyan	Dark Blue
Live Preview, Recording, Waiting for Trigger	Cyan	Red
Live Preview, Recording, Camera Triggered	Cyan	Yellow/Green
Live Preview, Cine Stored	Cyan	Green
Playback, Cine Stored	Cyan	Green

Part



5 Phantom CineFlash - Help



Updated: 09/23/2015

CineFlash allows you to save a copy of your Cine to non-volatile memory for later retrieval, and avoid costly downtime while you download from camera memory to a computer hard disk. When done with an experiment, just remove the CineFlash from the camera, insert it into its docking station connected to a PC, and drag-and-drop Cines from the CineFlash onto your computer disk.

The topics in this section focus is on how to install, edit and save Cine using the Phantom CineFlash.

5.1 Installing the Phantom CineFlash Docking Station

Footage from Phantom Miro M / R and LC camera models is stored on CineFlash drives as 10-bit log raw cine files. The CineFlash drive is formatted using the Linux Ext2 file system, and can be accessed from the camera body over Ethernet, or remotely using a Phantom CineFlash Dock via USB3 or eSATA.

The CineFlash Dock is compatible with both PC and Mac computers once the appropriate EXT2 driver is installed. This allows 3rd party solutions that can read Cine raw files to see the file directly from the CineFlash.

STEP-BY-STEP PROCEDURE

Prior to installing the supplied Paragon ExtFS Driver (USB drive) remove any existing ExtFS drivers from your computer. CineFlash Dock users without the USB drive or product key can download and purchase the latest Paragon ExtFS drivers at <https://www.paragon-software.com/>

1. Insert the USB Flash Drive.
2. Follow the appropriate installation PDF (supplied on USB drive) instructions for your operating system. During the installation process you will be asked to provide your 'Product Key' and 'Serial Number' (located on the bottom of the Phantom CineFlash Dock).



The Product Key and Serial Number, when installed, are bound to the computer on which the ExtFS driver is installed, not the Phantom CineFlash Docking Station. Therefore, Vision Research recommends you document these numbers along with the serial number of the computer the driver has been installed on in the event they are lost or worn off (unreadable). Vision Research will not be able to recover your Product Key or Serial Number for you.

3. Connect the Phantom CineFlash Dock via USB(3) or E-SATA, and insert a CineFlash drive. This should now mount to your operating system.

Once installed, the CineFlash will automatically be mounted when inserted into the dock. The CineFlash is less tolerant of being removed from the dock (disconnected from the computer) than a typical USB drive. Therefore, you should ALWAYS unmount the CineFlash before removing it from the dock or disconnecting the dock from the computer if it has a CineFlash in it. This ensures that all data is written and flushed to the disk before removing the drive.

Users can access, play, edit and save the cine files using Phantom PCC or the Phantom CineViewer software (Windows only). To view and play the cines on a Mac, the GlueTools Phantom Cine plugin is recommended and is available from GlueTools.com.

5.2 Editing and Saving a Cine to the Phantom CineFlash

To save a captured Cine file that has been recorded into the camera's memory buffer to a Phantom CineFlash:

STEP-BY-STEP PROCEDURE

Manual Save to CineFlash via Phantom Camera Control (PCC)

1. Using the Phantom Camera Control (PCC) software, select the Cine file to be saved.
 - a. Click the Play Panel Tab.
 - b. Click on the down-arrow to the right of the Cine: field, then
 - c. Select the Cine file, from the pull-down list, to open it in its own Playback Panel.
 - d. Edit the Cine:
 - 1) In the Play Panel:
 - a) Advance the Cine file to the first image you desire to save for the Cine clip via the Playback buttons, by performing a quick search, or by entering the image number you want to go to in the Jump field, then
 - b) Press the Pause button. The edit bar slider moves to the specified image.
 - 2) Click the  Mark In button. To the left of the specified image, the editor bar will turn gray, indicating that the gray area of the Cine file has been edited.
 - 3) Advance the Cine file forward until you reach the last image of the Cine file you wish to save in the clip, then

- 4) Press the Pause button. The edit bar slider moves to the specified image.
- 5) Click the  Mark Out button. To the right of the specified image, the editor bar will turn gray, indicating that the gray area of the Cine file has been edited. An image number will also be displayed below the editor bar image point indicator.



The blue portion of the line, in the Cine editor bar, represents the edited Cine file. The number displayed at the left end of the Cine editor bar refers to the first image in the entire Cine sequence. The number at the right end of the bar refers to the last image in the entire Cine sequence. The number just above the editor bar, in the center of the bar, indicates the number of the image presently being displayed in the playback panel. The numbers below the editor bar indicate the first and last image numbers of the edited Cine file, respectively. Zero represents the first image after the moment of trigger was detected by the camera regardless of what sample rate or resolution settings were set to in the Live Panel. Negative numbers represent pre-trigger frames and positive numbers represent post trigger frames.



- e. Click the down-arrow in the Save Cine button, and select the Save RAM to Flash option from the pop-up selection list. The software will display an Saving Cine To Flash message and display Saving To Flash progress indicator.

Auto Save to CineFlash via Phantom Camera Control (PCC)

1. Using the Phantom Camera Control (PCC) software:
 - a. After defining the Cine Settings, capture parameters, click the Advance Settings in the Live Panel Tab.
 - b. Locate the Start/End of Recording Actions area, then
 - 1) Enable, check, the Auto Save to CineFlash/CardFlash enable box.
 - 2) Enable, check, Full Cine to save the entire Cine capture to the Phantom Cine Flash, or
 - 3) Enter the number of the First Image in the sequence you want to save. For example, the event begins at image number -50 in the Cine file just recorded. By entering -50, all images recorded prior to image -50 will be discarded and will not be saved to this file.
 - 4) Enter the Last Image in the sequence you want to save. For example, the event ends at image number 1000 in the Cine file just recorded. By entering 1000, all images recorded after image 1000 will be discarded and will not be saved to this file.
 - c. Place the camera into the recording mode by clicking on the Capture button.
 - d. When ready, trigger the camera. The camera can be triggered by applying a:
 - 1) Soft trigger, clicking the Trigger button.
 - 2) Hard trigger, switch closure, or TTL pulse through the Trigger (BNC) connector.
 - 3) Soft trigger using the cameras' Image-Based Auto-Trigger feature. The software will return to the Live state when the save process has completed.

Manual Save to CineFlash via Phantom Video Player (PVP)

1. Using the Phantom Video Play (PVP) application, select the Cine file to be saved.
 - a. Place the camera into the recording mode by clicking the Capture button.
 - b. When ready, trigger the camera. The camera can be triggered by applying a:
 - 1) Soft trigger, clicking the Trigger button.
 - 2) Hard trigger, switch closure, or TTL pulse through the Trigger (BNC) connector.
 - 3) Soft trigger using the cameras' Image-Based Auto-Trigger feature.
 - c. Click on the down-arrow to the right of the Cine: field, then
 - d. Select the Cine file, from the pull-down list, to open.

- e. Edit the Cine:
- 1) Advance the Cine file to the first image you desire to save for the Cine clip via the Playback buttons, by performing a quick search, or by entering the image number you want to go to in the Jump field, then
 - 2) Press the Pause button. The edit bar slider moves to the specified image.
 - 3) Click the  Mark In button. To the left of the specified image, the editor bar will turn gray, indicating that the gray area of the Cine file has been edited.
 - 4) Advance the Cine file forward until you reach the last image of the Cine file you wish to save in the clip, then
 - 5) Press the Pause button. The edit bar slider moves to the specified image.
 - 6) Click the  Mark Out button. To the right of the specified image, the editor bar will turn gray, indicating that the gray area of the Cine file has been edited. An image number will also be displayed below the editor bar image point indicator.



The blue portion of the line, in the Cine editor bar, represents the edited Cine file. The number displayed at the left end of the Cine editor bar refers to the first image in the entire Cine sequence. The number at the right end of the bar refers to the last image in the entire Cine sequence. The number just above the editor bar, in the center of the bar, indicates the number of the image presently being displayed in the playback panel. The numbers below the editor bar indicate the first and last image numbers of the edited Cine file, respectively. Zero represents the first image after the moment of trigger was detected by the camera regardless of what sample rate or resolution settings were set to in the Live Panel. Negative numbers represent pre-trigger frames and positive numbers represent post trigger frames.

- f. Click the the Save to Flash button. The software will display Saving To Flash progress indicator.







5.3 Reviewing a Saved Cine File on a Phantom CineFlash

STEP-BY-STEP PROCEDURE

1. Select the Cine file to be reviewed.
 - a. If the Phantom Cine Flash is in the docking station:
 - 1) Click the Open File button in the PCC (Phantom Camera Control) graphical user interface.
 - 2) In the Open Cine dialogue window, navigate to the folder the Cine file is saved in, then
 - 3) Highlight the file, and click the Open button.
 - b. If the Phantom CineFlash is in the camera the end-user can select the saved Cine file from the:
 - 1) Manager Panel by:
 - a) Highlighting the Cine file to be reviewed, then clicking the Play Panel, or
 - b) Double mouse-click on the Cine file to be reviewed.
 - 2) Play Panel
 - a) Click the Play Panel Tab.
 - b) Click on the down-arrow to the right of the Cine: field.
 - c) Select the Cine file, from the pull-down list, to open it in its own Playback Panel.
2. Review the saved Cine using the video control buttons as follows:



Play Fast Rewind button to decrement the images being reviewed. The Cine file will play backwards the total number of Cine frames/1000, no less than 10 frames, auto adjusting to Cine size.

-  Play Fast Forward button to increment the images being reviewed. The Cine file will play forward the total number of Cineframes/1000, no less than 10 frames, auto adjusting to Cine size.
-  Standard Rewind button to play the Cine file in reverse. The Cine file will play backwards one player step at a time.
-  Standard Play button to play the Cine file. The Cine file will play forward player step at a time.
-  Pause button to stop or pause the playback process.
-  Step Backward button to rewind only one image. The Cine file will move backward one player step and stop.
-  Step Forward button to advance forward one image only. The Cine file will move forward one player step and stop.

5.4 Erasing a Saved Cine File on a Phantom CineFlash

STEP-BY-STEP PROCEDURE

1. Start the Phantom (PCC) Camera Control Application .
2. Select the Phantom camera housing the Phantom CineFlash by:
 - a. Clicking on the Manager Control tab, then
 - b. Double-click on the Phantom camera desired.
3. Erase a single or Cine files stored in the Phantom CineFlash by:
 - a. Clicking on the Live Panel, then
 - b. Click on the Flash Memory selector.
 - c. Click the Erase button.
 - d. When the dialog box will appear where thumbnails of the Cines are displayed and Cines can be deleted from select the appropriate command:
 - 1) Delete the selected Cine,
 - 2) Delete All the Cines stored on the Phantom CineFlash, or
 - 3) Format the Phantom CineFlash. The software will display an Erasing Flash message and display Erasing Flash progress indicator.

Part



6 Phantom CineMag - Help



Updated: 10/16/2014

This module describes the most common tasks you will use when working with a Phantom CineMag attached to a Phantom imaging system. It is designed as a 'How-To' guide. Although it is organized roughly in the order that one would perform the tasks one don't need to begin at the beginning and work their way through.

The topics in this section are intentionally kept as brief as possible. The focus is on how to do capture, view, edit and save Cine files using a Phantom CineMag.

6.1 Defining the Operational Mode

Phantom cameras that support a Phantom CineMag can operate in one of two operational mode, including:

Loop - In the Loop Mode, the camera stores the recorded image data into the camera's RAM buffer. In this mode, the Phantom CineMag operates like any other Flash card, after a Cine file is recorded into the camera's RAM frame buffer, you can manually save it into the CineMag using the 'Flash Memory' dialogue window which can be accessed in either the Setup and Recording or ViewCine dialogue windows.



This mode supports recording up to the maximum frame rate.

R/S (Run/Stop) - In Run/Stop Mode the image data is recorded, for a Phantom HD up to 450fps at HD resolution (2048 x 1080), directly into the Phantom CineMag.

STEP-BY-STEP PROCEDURE

Via the Phantom (PCC) Camera Control Application

1. Start the Phantom (PCC) Camera Control Application.
2. Select the Phantom Camera:
 - a. Click the Manger Control Panel tab.
 - b. Move the cursor over the desired available Phantom camera you wish to connect to, then
 - c. Double-click the left mouse key.
3. Select the Operational Mode.
 - a. Click on the Live Panel tab, then
 - b. Click on the Flash Memory selector.
 - 1) Disable, (uncheck), the 'Direct recording to CineMag' enable box to operate in Loop Mode.
 - 2) Enable, (check), the 'Direct recording to CineMag' enable box to operate in Run/Stop Mode.

Via the Phantom 65 or Phantom HD 'On-Camera' Control Buttons

1. From the LIVE PRE (Preview, Waiting for Pre-Trigger), or LIVE display screen:
 - a. Press the Select Setup button one time, then
 - b. Rotate the button to the Operational Mode field parameter. The field will change from yellow to red indicating the field has been selected for changed.
2. Once the Operational Mode field has been selected:
 - a. Hold in the Select Setup button, then
 - b. Rotate the button to the desired operational mode; Loop or R/S (Run/Stop).

Via the Phantom Flex 'On-Camera' Control Buttons

1. From any of the LIVE display screens:
 - a. Press the Settings button one time, then
 - b. Rotate the button to the Capture field parameter on Camera Display Screen 1/4. The field will change from yellow to red indicating the field has been selected for changed.
2. Once the Capture field has been selected:
 - a. Hold in the Settings Setup button, then
 - b. Rotate the button to the desired operational mode:
 - 1) Loop - In the Loop Mode the camera stores the recorded image data into the camera's RAM buffer. In this mode, the Phantom CineMag operates like any other Flash card, after a Cine file is recorded into the camera's RAM frame buffer, you can manually save it into the CineMag using Phantom Camera Control software.
 - 2) R/S (Run/Stop) - In Run/Stop Mode the image data is recorded directly into the Phantom CineMag.
3. Press the Trigger button one time to exit the Camera Setup Display Screens.

6.2 Recording to a Phantom CineMag

STEP-BY-STEP PROCEDURE

In Loop Mode via the Phantom (PCC) Camera Control Application

Use this option when you wish to edit and save a Cine file stored in the cameras RAM frame buffer to the optional Phantom CineMag non-volatile Flash memory unit manually.

1. Start the Phantom (PCC) Camera Control Application.
2. Select the Phantom camera.
 - a. Click on the Manager Control tab, then
 - b. Double-click on the Phantom camera desired.
3. Enable Loop Mode.
 - a. Click on the Live Panel tab.
 - b. Click on the Flash Memory selector, then
 - 1) Disable, (uncheck), the Direct recording to CineMag option in the CineMag options.
 - 2) Disable, (uncheck), the Auto save to CineMag/built-in Flash option in the Start/End of Recording actions options.
4. Define all camera capture settings.
5. Click on the Capture button.
6. Trigger the camera.
 - a. Apply a 'soft' trigger by:
 - 1) Clicking the Trigger button in the Live Panel, or
 - 2) Depressing the Ctrl+T keys simultaneously.
 - b. To apply a 'hard' trigger to the BNC connector marked Trigger on the 19-Pin Capture breakout cable attached to the rear panel of the camera by providing a,
 - 1) Dry switch closure.
 - i. Use of a pickle switch all cameras.
 - ii. Depressing the Trigger button on a Phantom 65 or HD camera.
 - 2) Low TTL pulse signal.
7. Manually Save the camera stored Cine file to the Phantom CineMag.
 - a. Click on the Play Control tab.
 - b. Edit the recorded Cine file, then
 - c. Click the down arrow on the right of Save Cine button and select the Save RAM Cine to Flash command from the pop-up selection window.
 - d. Take note of the Phantom CineMag indicators, and the On-Screen Display information.

Loop Mode via the Phantom 65/HD 'On-Camera' Control Buttons

1. Place camera into Loop Mode.
 - a. Hold-in and rotate the O C Select button to the Mode field.
 - b. Select Loop Mode.
 - c. Release Select button.

2. Place the camera into Capture (Record) Mode.
 - a. Push the on-camera control Trigger button to start recording directly into the camera's RAM.
3. Place the Camera into the PLAY CST, (Play Cine Stored), Mode.
 - a. Depress the Zoom button one time to place the camera into the PLAY CST (ViewCine) mode.
4. Select a Cine for Playback.
 - a. Hold the Zoom button in for 1 second to display the Cine SELECT screen.
 - b. Hold in and rotate the Select Setup button until the desired Cine is displayed.
 - c. Release the Select button.
5. Play/Pause the select Cine (Forward).
 - a. Depress the Zoom button a one time to instruct the camera to forward through the memory buffer or play the images stored in the memory buffer one image at a time until the end of the recording as been reach or the user pauses the playback process.
 - b. Depress the button a second time to pause the playback process.
6. Play/Pause the select Cine (Reverse).
 - a. Depressing the Trigger button one time instructs the camera to play the image in reverse, continuously one image at a time.
 - b. Depressing the button a second time will pause the playback process.
7. Step through the select Cine.
 - a. Rotate the Select Setup button clockwise will step forward through the recorded images one image at a time.
 - b. Rotating the button counter-clockwise will step backwards through the recorded images one image at a time.
8. Edit the recorded Cine.
 - a. Set Mark In.
 - 1) Rotate the Select Setup button to the Memory Buffer Graphical Representation field, then
 - 2) Hold in and rotate the Select Setup button until the desired starting image is displayed on the monitor or in the viewfinder.
 - 3) Release the Select Setup button.
 - 4) Rotate the Setup Select button to the Edit field.
 - 5) Hold in the Select Setup button, then
 - 6) Rotate it until the Mark In option is displayed on the monitor or viewfinder, then
 - 7) Release.



The memory buffer graphical representation will now display a vertical line marking the end point of the Cine file to be played back.

- b. Set Mark Out.
 - 1) Rotate the Select Setup button to the Memory Buffer Graphical Representation field, then
 - 2) Hold in and rotate the Select Setup button until the desired starting image is displayed on the monitor or in the viewfinder.
 - 3) Release the Select Setup button.
 - 4) Rotate the Setup Select button to the Edit field.
 - 5) Hold in the Select Setup button, then
 - 6) Rotate it until the Mark Out option is displayed on the monitor or viewfinder, then

7) Release.



The graphical representation of the memory buffer will now display a vertical line marking the starting point for the Cine file to be played back.

9. Save the Cine to the CineMag
 - a. Hold in the Select button and rotate counter-clockwise to the Save option
 - b. Release

Loop Mode via Phantom Flex 'On-Camera' Control Buttons

1. Place the camera into Loop Mode.
 - a. From any of the LIVE display screens:
 - 1) Press the Settings button one time, then
 - 2) Rotate the button to the Capture parameter field on Camera Display Screen (Screen 1/4). The field will change from yellow to red indicating the present field location.
 - 3) Press the Settings button a second time to select the field to be changed. The field will change from red to green indicating the parameter field has been selected for changed.
 - b. Once the Capture field has been selected:
 - 1) Hold in the Settings Setup button, then
 - 2) Rotate the button to the loop operational mode.
 - c. Press the Trigger button one time to exit the Camera Setup Display Screens.
2. Place the camera into Capture (Record) Mode.
 - a. From the LIVE PRE Display Screen, depress the Trigger button to place the camera into the LIVE WTR (Preview, Waiting for Trigger) or capture/recording mode.
 - b. From the LIVE CST(Cine Stored), PLAY CST Display Screens, depress and hold the Trigger button in for approximately 6-seconds to place the camera into the LIVE WTR (Preview, Waiting for Trigger) or capture/recording mode.
 - c. From the Select Display Screen, depress the Trigger button to return to the LIVE CST Display Screen then perform Step 2 to place the camera into the LIVE WTR (Preview, Waiting for Trigger) or capture/recording mode.



If the camera is set to record pre-trigger images the Memory Buffer Graphical Display will show the memory allocation progress, indicating how much of the memory buffer has been filled with image data or frames. It does not, however, display the camera's ability to continuously re-allocate newer images into its scrolling buffer. If a Cine has previously been stored into the camera's RAM you must hold in the Trigger button for approx. 6-seconds to place the camera in the LIVE WTR state.

3. Trigger the camera.
 - a. Depress the Trigger button when the camera is in the LIVE WTR mode to trigger to the camera.



If the camera was set to capture post trigger frames, (Loop Mode only), the camera will be placed into the LIVE TRG (Recording, Cine Triggered) state. When the camera stops recording the desired number of user defined post trigger frame into the camera's memory, the camera will be placed into the LIVE CST (Cine Stored or ready for playback) state.

4. Select a Cine for Review
 - a. Press the Select button to access the Select Display Screen.
 - b. From the Select Display Screen, rotate the Settings button to the Cine to be reviewed, then

- c. Depress the Select button again.
5. Play/Pause the selected Cine (Forward).
 - a. Select a recorded Cine to be reviewed.
 - b. Depress B-REF button one time to instruct the camera to play the images one image at a time until the end of the recording as been reach or the user pauses the playback process.
 - c. To Fast Forward the Cine playback hold in the B-REF button for approximately 2-seconds.
 - d. To pause the playback process depress the B-REF button a second time.
6. Play/Pause the selected Cine (Reverse).
 - a. Select a recorded Cine to be reviewed.
 - b. Depress Tools button one time to instruct the camera to play the images one image at a time until the beginning of the recording as been reach or the user pauses the playback process.
 - c. To Fast Reverse the Cine playback hold in the Tools button for approximately 2-seconds.
 - d. To pause the playback process depress the Tools button a second time.
7. Scroll through the selected Cine.
 - a. Select a recorded Cine to be reviewed.
 - b. Rotate the Settings Setup button clockwise to scroll forward through the recorded images.
 - c. Rotate the button counter-clockwise to scroll backwards through the recorded images.
8. Edit the selected Cine.
 - a. Set the Mark-In Point.
 - 1) From the PLAY CST Display Screen:
 - a) Rotate the Settings button clockwise to scroll forward through the recorded images or rotate the button counter-clockwise to scroll backwards through the recorded images until the desired starting image is displayed on the monitor or in the viewfinder, then
 - b) Hold in and rotate the Settings button, clockwise, until the Set-In field is displayed in the lower left-hand corner of the display screen, then
 - c) Release the Settings button.
 - b. Set the Mark-Out Point.
 - 1) From the PLAY CST Display Screen:
 - a) Rotate the Settings button clockwise to scroll forward through the recorded images or rotate the button counter-clockwise to scroll backwards through the recorded images until the desired starting image is displayed on the monitor or in the viewfinder, then
 - b) Hold in and rotate the Settings button, clockwise, until the Set-Out field is displayed in the lower left-hand corner of the display screen, then
 - c) Release the Settings button.
9. Save the selected Cine to an attached Phantom CineMag.
 - a. From the PLAY CST Display Screen hold in and rotate the Settings button, counter-clockwise, until the Save field is displayed in the lower left-hand corner of the display screen, then
 - b. Release the Settings button.

In Run-Stop Mode (via Phantom (PCC) Camera Control Application)

1. Start the Phantom (PCC) Camera Control Application .
2. Select the Phantom camera.

- a. Click on the Manager Control tab, then
- b. Double-click on the Phantom camera desired.
3. Enable Run-Stop Mode.
 - a. Click on the Live Panel tab.
 - b. Click on the Flash Memory selector.
 - c. Enable, (check), Direct recording to CineMag. Capture button will become Record button. Post trigger frames value will be set automatically to 1.
4. Define all camera capture settings, then
5. Click on the Record button. The button will be renamed with Stop recording.
6. Trigger the camera.
 - a. Apply a 'soft' trigger by:
 - 1) Clicking the Record button in the Live Panel, or
 - 2) Depressing the Ctrl+T keys simultaneously.
 - b. To apply a 'hard' trigger to the BNC connector marked Trigger on the 19-Pin Capture breakout cable attached to the rear panel of the camera by providing a,
 - 1) Dry switch closure, or
 - i. Use of a pickle switch all cameras.
 - ii. Depressing the Trigger button on a Phantom 65 or HD camera.
 - 2) Low TTL pulse signal.
 - c. Take note of the Phantom CineMag indicators, and the On-Screen Display information.

In Run-Stop Mode (via the Phantom 65/HD'On-Camera' Control Button)

1. Place camera into R/S Mode.
 - a. Hold-in and rotate the on camera control Select button to the Mode field.
 - b. Select R/S Mode.
 - c. Release Select button.
2. Place the camera into Capture (Record) Mode.
 - a. Push the on-camera control Trigger button to start recording directly into the Phantom CineMag.
 - b. Notice that the Activity and Record indicators are on, and the Total Time Available and Number of Frames Available fields, on the On-Screen Display, are decrementing.
 - c. Release the on-camera control Trigger button to stop recording.
 - d. Take note of the Phantom CineMag indicators, and the On-Screen Display information.

In Run-Stop Mode (via Phantom Flex 'On-Camera' Control Buttons)

1. Place the camera into R/S Mode.
 - a. From any of the LIVE display screens:
 - 1) Press the Settings button one time, then
 - 2) Rotate the button to the Capture parameter field on Camera Display Screen (Screen 1/4). The field will change from yellow to red indicating the present field location.
 - 3) Press the Settings button a second time to select the field to be changed. The field will change from red to green indicating the parameter field has been selected for changed.
 - b. Once the Capture field has been selected:

- 1) Hold in the Settings Setup button, then
- 2) Rotate the button to the loop operational mode.
- c. Press the Trigger button one time to exit the Camera Setup Display Screens.
2. Place the camera in Capture (Record) Mode.
 - a. From the LIVE Display Screen, depress the Trigger button to place the camera into the LIVE REC (recording), mode.
3. Trigger the camera.
 - a. From the LIVE REC Display Screen:
 - 1) Hold in the Trigger button for approximately 2-seconds to start recording image data directly into an attached Phantom CineMag.
 - 2) To stop recording to the Phantom CineMag, depress the Trigger button a second time.
 - 3) Repeat these steps until all required Cines have been recorded.

6.3 Viewing a Cine File Stored in Phantom CineMag



If a Cine is stored in a CineMag it can only read it from one source.

Example: If you have Cine F1 cued up in the play window you will not be able to play it or any other stored Cine back in PVP until you close the window in Play. This also works the other way, if you have F1 open in PVP you cannot open it in Play to view. The CineMag only allows one operation at a time. What the software does is revert to a live image if you attempt to do this.

STEP-BY-STEP PROCEDURE

Via the Phantom (PCC) Camera Control Application

1. Start the Phantom (PCC) Camera Control Application .
2. Select the Cine File(s) to be reviewed.
 - a. Click on the Manager Control tab, then
 - b. Double-click on the Cine file(s) to be reviewed. The file stored in non-volatile Phantom CineMag Flash will be indicated by the letter "F" preceding the Cine file count, i.e., F1, F2, F3, etc.

Via the Phantom 65 or Phantom HD 'On-Camera' Control Buttons

1. Once a Cine file has been recorded the camera will be placed into the LIVE CST mode.
2. Place the camera into the PLAY CST mode by depressing the Zoom button one time, this will place the camera into the ViewCine state.
3. Select a Cine for playback:
 - a. Hold the Zoom button in for 1 second to display the Cine SELECT screen.
 - b. Hold in and rotate the Select Setup button until the desired Cine is displayed.
 - c. Release the Select button.
4. Play/Pause the select Cine (Forward):
 - a. Depressing the Zoom button a one time to instruct the camera to forward through the memory buffer or play the images stored in the memory buffer one image at a time until the end of the recording as been reach or the user pauses the playback process.

- b. Depressing the button a second time to pause the playback process.
5. Play/Pause the select Cine (Reverse):
 - a. Depressing the Trigger button one time instructs the camera to play the image in reverse, continuously one image at a time.
 - b. Depressing the button a second time will pause the playback process.
6. Step through the select Cine:
 - a. Rotate the Select Setup button clockwise will step forward through the recorded images one image at a time.
 - b. Rotating the button counter-clockwise will step backwards through the recorded images one image at a time.

Via the Phantom Flex 'On-Camera' Control Buttons

1. Once a Cine file has been recorded:
 - a. Select a Cine for Review
 - 1) Press the Select button to access the Select Display Screen.
 - 2) From the Select Display Screen, rotate the Settings button to the Cine to be reviewed, then
 - 3) Depress the Select button again.
 - b. Play/Pause the selected Cine (Forward).
 - 1) Select a recorded Cine to be reviewed.
 - 2) Depress B-REF button one time to instruct the camera to play the images one image at a time until the end of the recording as been reach or the user pauses the playback process.
 - 3) To Fast Forward the Cine playback hold in the B-REF button for approximately 2-seconds.
 - 4) To pause the playback process depress the B-REF button a second time.
 - c. Play/Pause the selected Cine (Reverse).
 - 1) Select a recorded Cine to be reviewed.
 - 2) Depress Tools button one time to instruct the camera to play the images one image at a time until the beginning of the recording as been reach or the user pauses the playback process.
 - 3) To Fast Reverse the Cine playback hold in the Tools button for approximately 2-seconds.
 - 4) To pause the playback process depress the Tools button a second time.
 - d. Scroll through the selected Cine.
 - 1) Select a recorded Cine to be reviewed.
 - 2) Rotate the Settings Setup button clockwise to scroll forward through the recorded images.
 - 3) Rotate the button counter-clockwise to scroll backwards through the recorded images.

6.4 Editing a Cine File Stored in Phantom CineMag

STEP-BY-STEP PROCEDURE

Via the Phantom (PCC) Camera Control Application

1. Start the Phantom (PCC) Camera Control Application.
2. Select the Cine File(s) to be reviewed:
 - a. Click on the Manager Control tab, then
 - b. Double-click on the Cine file(s) to be reviewed. The file stored in non-volatile Phantom CineMag Flash will be

indicated by the letter "F" preceding the Cine file count, i.e., F1, F2, F3, etc.

3. Set the Mark In Point.
 - a. Use the Playback button to locate the desired starting image, then
 - b. Click the Mark In button.
4. Set the Mark Out Point.
 - a. Use the Playback button to locate the desired ending image, then
 - b. Click the Mark Out button.
5. Click on the Play Speed & Options selector.
 - a. Enable, (check), Limit to Range, then
 - b. Enable, (check), Repeat.
6. Review the edited Cine file.
7. Save the selected Cine to the Phantom Control Unit.

Via the Phantom 65 or Phantom HD 'On-Camera' Control Button

1. Setting the Mark In Point
 - a. Rotate the Select Setup button to the Memory Buffer Graphical Representation field, then
 - b. Hold in and rotate the Select Setup button until the desired starting image is displayed on the monitor or in the viewfinder.
 - c. Release the Select Setup button.
 - d. Rotate the Setup Select button to the Edit field.
 - e. Hold in the Select Setup button, then
 - f. Rotate it until the Mark In option is displayed on the monitor or viewfinder.
 - g. Release.
 - h. Save the selected Cine file to the Phantom Control Unit.
2. Setting the Mark Out Point
 - a. Rotate the Select Setup button to the Memory Buffer Graphical Representation field, then
 - b. Hold in and rotate the Select Setup button until the desired ending image is displayed on the monitor or in the viewfinder.
 - c. Release the Select Setup button.
 - d. Rotate the Setup Select button to the Edit field.
 - e. Hold in the Select Setup button, then
 - f. Rotate it until the Mark Out option is displayed on the monitor or viewfinder, then
 - g. Release.



The memory buffer graphical representation will now display a vertical line marking the end point of the Cine file to be played back.

- h. Save the selected Cine file to the Phantom Control Unit.

Via the Phantom Flex 'On-Camera' Control Buttons

1. Set the Mark-In Point
 - a. From the PLAY CST Display Screen:

- 1) Rotate the Settings button clockwise to scroll forward through the recorded images or rotate the button counter-clockwise to scroll backwards through the recorded images until the desired starting image is displayed on the monitor or in the viewfinder, then
 - 2) Hold in and rotate the Settings button, clockwise, until the Set-In field is displayed in the lower left-hand corner of the display screen, then
 - 3) Release the Settings button.
2. Set the Mark-Out Point
 - a. From the PLAY CST Display Screen:
 - 1) Rotate the Settings button clockwise to scroll forward through the recorded images or rotate the button counter-clockwise to scroll backwards through the recorded images until the desired starting image is displayed on the monitor or in the viewfinder, then
 - 2) Hold in and rotate the Settings button, clockwise, until the Set-Out field is displayed in the lower left-hand corner of the display screen, then
 - 3) Release the Settings button.

6.5 Erasing Files from the Phantom CineMag



Be sure to Save all the Cine files stored in Phantom CineMag you want to keep before erasing the Phantom CineMag Flash memory. This is an all-or-nothing selection, the memory can only be erased in its entirety, individual files cannot be purged separately. To use Erase Protect feature place the Erase Protect Switch, located underneath the Phantom CineMag, into the locked position, indicating the CineMag is in Erase Protect Mode. The Erase Protect Indicator will then be active.

STEP-BY-STEP PROCEDURE

Via the Phantom (PCC) Camera Control Application

1. Start the Phantom (PCC) Camera Control Application .
2. Select the Phantom camera.
 - a. Click on the Manager Control tab, then
 - b. Double-click on the Phantom camera desired.
3. Erase all Cine files stored in the Phantom CineMag.
 - a. Select Live panel.
 - b. Open Flash Memory subpanel and click on the Erase button.
 - c. Confirm pressing Yes when asked to Continue by erasing flash. All Cines recorded in the CineMag will be erased.

Part



7 Service & Support



AMECARE Service Offerings

Maintenance, Support and Education that delivers ultimate satisfaction and operational confidence for the user

Product and operator performance directly impact your goals and objectives. To ensure maximum product uptime and operator success, Vision Research offers a complete line of service programs, extended warranties and training classes to meet your specific product or operational needs. Our professional, factory trained service engineers and educators will deliver this training and support through a network of service centers, on-line/self-serve content and user community forums that will help you achieve the results you need.

Customer Service – General inquires, technical troubleshooting or ‘how to’ questions? We’re here to help. Our support centers are staffed from 8:00 AM to 5:00 PM Local Time.

- Professional Repair Services – Fast, accurate and competitively priced repairs for all of your product needs
- Extended Warranties – Designed to add peace of mind and extend the factory warranty coverage that eliminates unexpected out of pocket expenses
- Customer Training – Delivered in a Basic and Advanced format designed to get you quickly using our cameras or to explore the depths of our comprehensive feature set
- On-Site Predictive Support and Training – is designed for customers who have 5 or more cameras. This optional service program offers our customers the opportunity to receive a 1 day visit for refresher training, camera inspection, firmware upgrades and general maintenance

[View](#) a list of AMECare documents available for download

7.1 Vision Research Worldwide Service Network



Updated: 11/10/2017

For answers to many questions, please search the [VRI Knowledge Base](#)

If you have a technical question, there are a variety of tools available to you:

- For community support, try the [PhantomZone](#) discussion forums
- Visit our Vision Research customer community at <https://phantom-service.force.com/> for a variety of resources.
- Contact us for technical questions and service inquiries by entering a support ticket: <https://phantom-service.force.com/VisionResearchContactUsForm>
- Finally, feel free to call us at the numbers below.

Phone Support Info & Hours

Global Headquarters:	Serving the Americas:
<p>Vision Research, Inc. 100 Dey Road Wayne, New Jersey 07470 USA T: +1.973.696.4500 F: +1.973.696.0560</p>	<p>M-F 9:00 AM to 5:00 PM EST (GMT-5:00)</p> <p>Vision Research, Inc. 100 Dey Road Wayne, New Jersey 07470 USA</p> <p>Customer Service: +1.973.692.4002 Technical Support: +1.973.692.4003 Fax: +1.973.696.0560</p>

Serving the EMEA Region:	Serving the Asia Pacific Region:
<p>M-F 9:00 AM to 6:00 PM GMT +2:00</p> <p>Vision Research, Inc. Str. Eugen Botez Nr. 1 Bucharest, Romania, 020232 T: +40 21 210 8587 F: +40 21 210 8587</p>	<p>M-F 8:00 AM to 5:00 PM GMT +8:00</p> <p>Vision Research, Inc. Part A, 1st Floor, No.460 North FuTe Rd, Waigaoqiao Free Trade Zone Pudong, Shanghai T: 86-21- 58685111, ext:141</p>

7.2 Phantom Certification Program

Vision Research proudly offers a new program that delivers a comprehensive training solution for users of Phantom cameras. The Phantom v-Series Camera Certification Training Program is a two-tiered training program that can reduce in-house training expenses and enhance your workforces' productivity.

Our Phantom v-Series Camera Certification Training Program helps engineers and technicians better understand Phantom cameras, as well as the use of Phantom software, accessories, and applications for high-speed imaging; that will deliver high quality technical and product education you require.

Our instructors provide an in-depth customer-focused hands-on learning experience for our Phantom products as well as the basics in photography through a combination of lectures; exercises, labs, and training solutions. Class size is limited to eight students per session to ensure that each student receives the individual attention he or she may need.



"Our Phantom v-Series Camera Certification Training Program helps engineers and technicians better understand Phantom implementations, use of Phantom software and hardware, and applications," says Frank Mazella, Chief Instructor for Vision Research, "and delivers high quality technical and product education our customers' require. We believe this will allow them to maximize the use of our products and the effectiveness of their personnel.

Registration

The registration fee(s) for the Phantom Operator Certification Training Course are:

- Phantom Operator Certification Training – Level I and Level II (2 days) - **\$2,000 (US)** per person, and
- Phantom Operator Certification Training – Level II only (1 Day) - **\$1,150 (US)** per person.

Vision Research reserves the right to accept or decline registrations, and to cancel the course and return all registration fees if enrollment is insufficient. No refunds will be made to participants who fail to cancel by at least five (5) working days before the course starts. Cancellations will be charged a \$200 service fee if made more than 5 working days prior to the start of the course. Substitutions may be made at any time without penalty.

If you are interested in attending, or have any question regarding the training, please contact your local Vision Research sales representative; or, use our ["Contact Us"](#) form to request more information.

[Click here](#) for a schedule of our training classes.

If you are in need of training for television or motion picture production applications, please contact [AbelCine](#) if you are in the US or Canada, or your local Phantom sales representatives worldwide.

www.phantomhighspeed.com

Vision Research - Corporate Headquarters
100 Dey Road
Wayne, New Jersey 07470
USA

Ph: +1.973.696.4500
Toll Free: 800.737.6588
Fax: +1.973.696.0560

ViSiON
RESEARCH

 PHANTOM[®]
when it's too fast to see, and too important not to[®]

AMETEK[®]
MATERIALS ANALYSIS DIVISION